

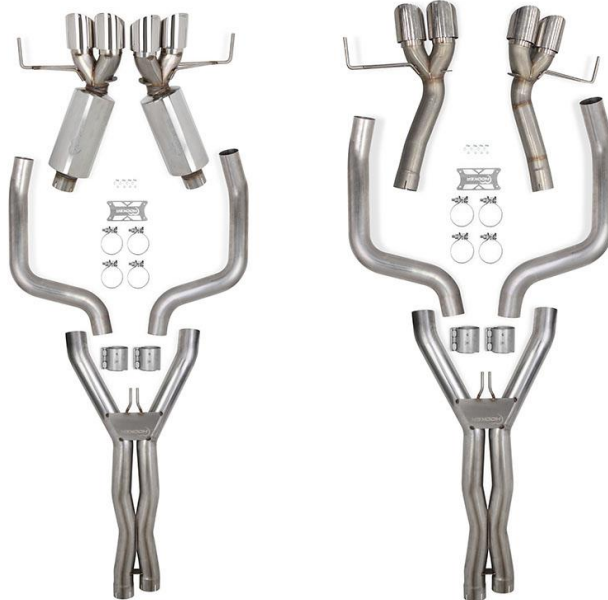

**2015-2016 C7 Corvette Z06
Blackheart 3" 304SS Cat-Back Exhaust System
70501369-RHKR (w/ Mufflers) & 70501370-RHKR (w/o Mufflers)
Installation Instructions**



Thank you for making HOOKER HEADERS your choice in a high-performance exhaust system. Extensive dyno/track testing has enabled HOOKER to offer the most advanced design in exhaust systems. The installation, while not complex, will take a certain amount of time. However, the additional horsepower and improved performance will more than justify your efforts. Proper installation and maintenance will ensure long life and maximum performance from your HOOKER BLACKHEART exhaust system.

BEFORE STARTING:

Your vehicle must be raised a minimum of 18 inches. A floor hoist is ideal. If no hoist is available, we strongly urge the use of axle stands as a safety measure. **Please read and understand these instructions and disclaimer in their entirety before attempting installation.**

IMPORTANT! Cutting the factory X-pipe is required to install this exhaust system.

CAUTION! WORK ONLY ON A LEVEL SURFACE. USE JACKS /JACK STANDS OF SUFFICIENT CAPACITY TO LIFT AND SUPPORT YOUR VEHICLE. NEVER WORK UNDER A VEHICLE SUPPORTED BY A FLOOR OR BUMPER JACK.

INCLUDED HARDWARE:

Accessory Pack Contents:		
P/N	Qty.	Description
556R23	2	76mm Band Clamps
199R11028	1	Instruction Sheet
505R57	4	5mm x 14mm Bolts
546R12	4	5mm Lock Washers
539R23	4	5mm Nuts
599R94	2	Blackheart Decals
517R63	1	Hooker Logo Plate
556R27	2	3" Torca Couplers
556R28	2	2 3/4" Band Clamps

Parts List:	
Qty.	Description
1	Left Over-Axle Pipe
1	Right Over-Axle Pipe
1	Left Muffler or Muffler Delete
1	Right Muffler or Muffler Delete
1	X-Pipe

Tools Needed:
Spray Lube (WD 40®)
3/8" Drive Metric Socket Set
12" 3/8 Drive Extension
3/8 Universal
15mm - 18mm Deep Sockets
1/4" Socket Set w/ 7mm Socket
Small Flat Blade Screwdriver
8mm Wrench
Reciprocating Saw
Rotary File / Round File
Measuring Tape

INSTALLATION:

IMPORTANT: Inspect your accessory pack: BEFORE YOU START!

1. Place the vehicle on flat a surface, set the parking brake, and block the front wheels.
2. Disconnect the battery.
3. Lift the vehicle and support with jack stands.

WARNING! Never support a vehicle with a floor or bumper jack.

REMOVING THE OEM EXHAUST:

NOTE: Removal of the rear bumper fascia is necessary and will require a second person to help with the removal and re-installation.

1. Remove the screws behind the license plate (x2), above the exhaust tips (x2) and bottom of the bumper cover (x5 each side – 10 total).
2. Remove the small plastic mud flap from inside the rear wheel arch.
3. Release the side vents from the bumper cover by pushing the tab locks from inside the wheel well. Be careful not to break the locks.

NOTE: Release the vents from the bumper cover only, the vent insert will stay connected to the fascia.

4. Remove the reflectors by pushing the mounting tabs from the back side of the fascia after the side vents have been released from the bumper cover and all the screws have been removed from the bottom of the fascia and tip box. Be very careful not to break the tabs. Remove the remaining (x2) screws behind the reflectors. See **Figures 1, 2, & 3.**
5. Release the clips on the top edge of fascia from the inside and pull outward and up while holding the tabs on the clips. Be careful not to break the tabs on the clips. Take your time and do one at a time. **NOTE:** Place a small piece of tape on the fascia at the back up camera to prevent the camera from scratching the paint on the fascia as it pulls out.
6. Remove the fascia and place out of the way.



Figure 1

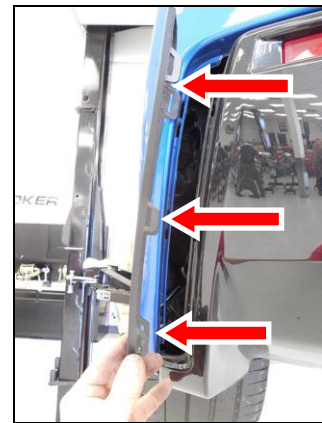

Figure 2

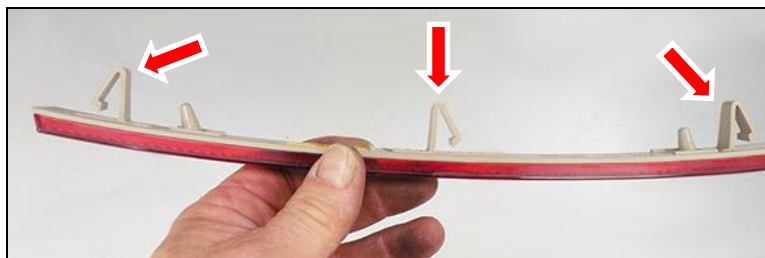

Figure 3

7. Remove the bolts on the lower skid plate and remove.

8. Support the X-pipe and remove the (x4) 15mm nuts at the flanges on the down pipes (**Figure 4**). Loosen the 15mm clamp bolts at the slip joint connecting the X-pipe to the over-axle pipes (**Figure 5**). Remove the (x2) 13mm bolts at the center support hanger on the X-pipe (**Figure 5**). Remove the X-pipe from the over-axle pipes.

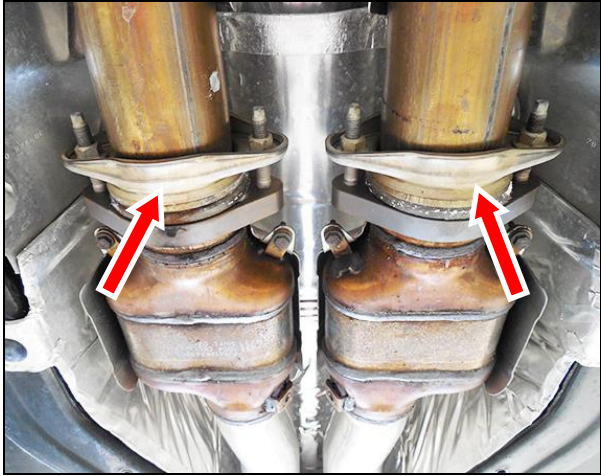

Figure 4

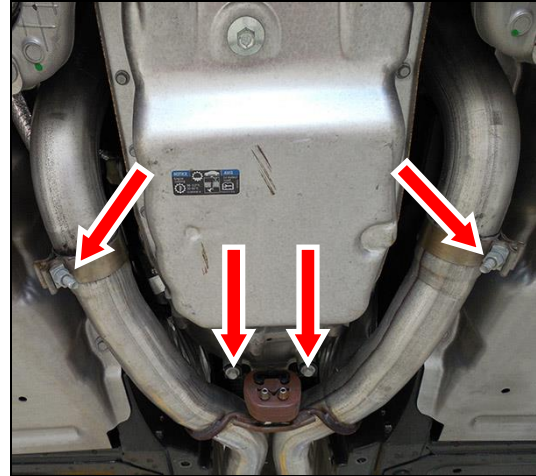

Figure 5

9. Remove the 13mm bolts at each muffler hanger (x2 each). Remove the (x2) 13mm bolts between the mufflers.

10. Unplug the electrical connector on each NPP valve at the muffler.

NOTE: To unlock the connectors, push down on the GREY lock tab and slide the lock backwards away from the valve. Unplug the connector.

NOTE: Automatic transmissions must be placed in neutral for the driver's side over-axle pipe to clear the linkage. Following the procedure to place the vehicle in "service mode" will allow the shifter to be moved from PARK with the engine off. Be sure to shut the ignition off after the shifter is moved from park to prevent the battery from being drained.

11. Remove the left and right muffler assemblies from the vehicle.

INSTALLATION OF THE BLACKHEART CAT-BACK EXHAUST:

1. Lay the factory X-pipe on the ground with the heat shields facing up. Mark the catalytic converters LEFT and RIGHT. Cut the catalytic converters from the factory X-Pipe using a reciprocating saw. Cut the pipes at the locations listed in **Figure 6**.
 - A. 17-1/8" from the front face of the RIGHT flange
 - B. 15-7/8" from the front face of the LEFT flange

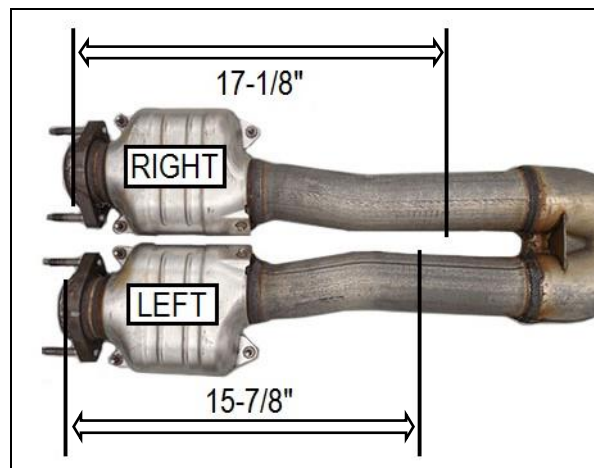

Figure 6

2. Deburr the pipes inside and outside
3. Install the 2-3/4" band clamps onto each inlet pipe of the Blackheart X-pipe (expanded end with notches). The clamps need to be installed with the bolt of the clamp on the bottom of the pipe and the nut between the two pipes facing outward (**Figure 7**). This alignment will put the threaded stud of the clamp in the cut out of the skid plate when installed (**Figure 8**).



Figure 7

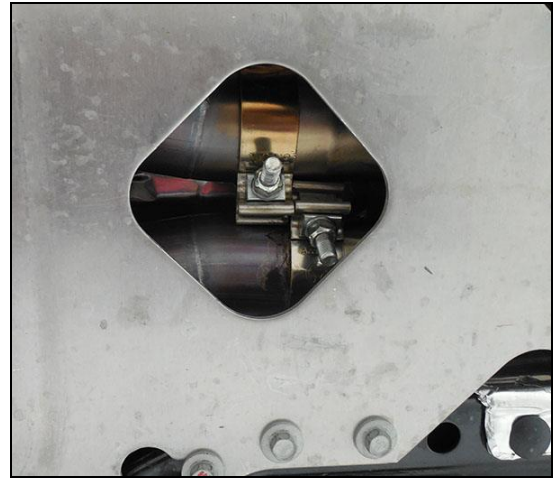

Figure 8

4. Install the RIGHT catalytic converter with the heat shield facing up, into the X-pipes short expanded pipe. Tighten the clamp to allow for adjustment.
5. Install the LEFT catalytic converter with the heat shield facing up, into the X-pipes long expanded pipe. Tighten the clamp to allow for adjustment.
6. Install the X-pipe with cats onto the down pipes and tighten the (x4) 15mm nuts to allow for adjustment. Support the X-pipe assembly. Install the center support hanger assembly and tighten the (x2) 13 mm bolts (**Figure 5**). Adjust the position of the cats if necessary and tighten the (x4) 15mm nuts (**Figure 4**). Install the 3" Torca couplers onto the outlet of the X-pipe with the bolts towards the transmission and the nuts facing down.
7. Install the left and right over-axle pipes. Install the pipe over the axle and align with the X-pipe. Slide the coupler from the X-pipe on to the over-axle pipe. Adjust the coupler for 50/50 coverage of the two pipes. Tighten the clamps to allow for adjustment (**Figure 9**). **NOTE:** Z06 kits do not use AFM valves – picture for reference only.
8. Install the 76mm band clamps onto the inlet pipes of the mufflers or muffler delete pipes. Position the clamp with the bolt at the top of the pipe and the nut facing outwards towards the tire (**Figure 10**).

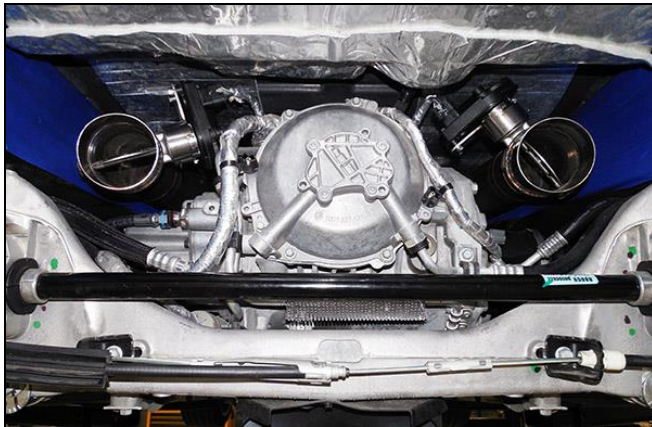

Figure 9

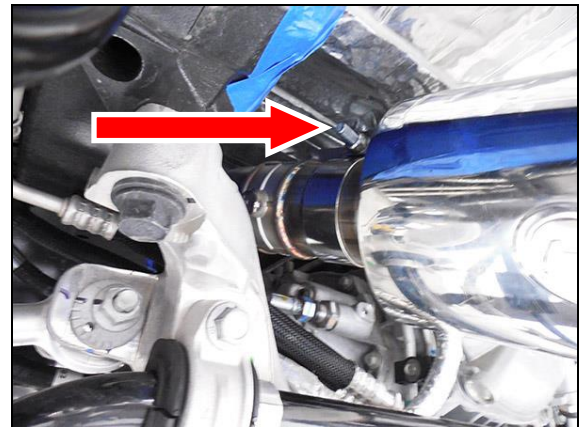

Figure 10

9. Remove the muffler hanger isolators from the OEM mufflers and install on to the Blackheart mufflers or muffler delete pipes.
10. Install the left and right mufflers or muffler delete pipes onto the over-axle pipes. Locate the muffler hangers at the bolt holes and install the (x2) 13mm bolts on each muffler assembly. Tighten the 76mm band clamp on the muffler to allow for adjustment.
11. Install the Hooker Logo plate between the mufflers with the supplied 5mm hardware and tighten to allow for adjustment.
12. Adjust the pipes for best clearance and tip alignment with the rear fascia removed. Use a straight edge to align the tips and tighten all hardware starting at the front and working towards the rear. Final tip alignment will be done after the rear fascia is installed.
13. Install the rear fascia in reverse order it was removed.

NOTE: Be sure the two locator tabs on either side of the backup camera go into the slots in the bumper cover and not under them. It will be helpful to lift up on the center of the fascia through the opening in the center of the fascia pushing the tabs up into the slots and under the backup camera. Keep pressure inward as the remainder of the locking tabs are aligned and pressed into place.

14. Install the hardware, reflectors, side vent grates, mud flaps, and license plate.
15. If additional alignment is necessary, loosen the clamps at the X-pipe and the mufflers. Adjust the depth and alignment of the tips by rotating the pipes and moving the mufflers in or out on the tubes as necessary. After the desired alignment is achieved, tighten the logo plate hardware. Tighten the clamps on the X-pipe and muffler.
16. Re-check all hardware, clearances and electrical connections.
17. Install the skid plate. Do not over tighten the bolts as it is easy to damage the inserts.
18. Remove the jack stands and lower the car. Connect the battery and remove the wheel blocks.
19. Start the vehicle and check for leaks and loose hardware. Check all hardware again after the first 150 miles of driving.

Enjoy your Blackheart Exhaust!

LIMITATION OF LIABILITY – DISCLAIMER:

The regulation of emissions production, noise levels, and safety standards is undertaken by the federal government, each of the fifty state legislatures, and by many local municipalities, towns, and counties.

HOOKER™ makes no warranties of merchantability, of fitness for particular purpose, or that its products are approved for general use, or that its products comply with laws, regulations, or ordinances in the state where they may be sold to the ultimate purchaser, the consumer.

Unless expressly stated to the contrary in the catalog, instruction sheet; or price list, the entire risk as to the conformity of any company product in any such state and as to repair should the product prove to be defective or non-conforming, is on the retail purchaser, the buyer, the ultimate consumer, of such product and it is not upon the seller, distributor, or manufacturer.

In this connection, the retail purchaser, the buyer, the ultimate consumer assumes the burden of the entire cost of any and all necessary service, alterations, or repair.

THE FOREGOING STATEMENT LIMITS THE LIABILITY OF THE MANUFACTURER.

California vehicle code, sections 27156 and 38391, prohibits the advertising, offering for sale, or installation of any device, which modifies a vehicle's emission control system, unless exempted, unless otherwise noted. HOOKER™ Headers that have not received an Executive Order (E.O.) exemption from these code sections are not legal for sale or use in California on vehicles originally equipped with catalytic converters, except for racing vehicles, which may never be driven upon a highway. Check with your local authorities to determine if these headers are legal for use in your particular area.

Technical Support: 1-866-464-6553

© 2016 Hooker Headers, Inc. All rights reserved.

199R11028

Date: 4-12-16