



To download this manual or others, go to: www.demoncarbs.com

INTRODUCTION

Demon Carburetors™ have many unique features that make them the ultimate choice for performance enthusiasts, like yourself. Whether it is everyday driving or just getting the most out of your hot rod, Road Demon™ will give you the necessary edge over others. This manual will discuss the special points and unique features of the carburetor, and the correct procedures for their proper installation and tuning. The goal is to help you understand the thoughts behind the Demon™, and to increase your knowledge of carburetion on a whole. Please read and understand this manual completely to assure that you get the most out of your new Demon™ carburetor.

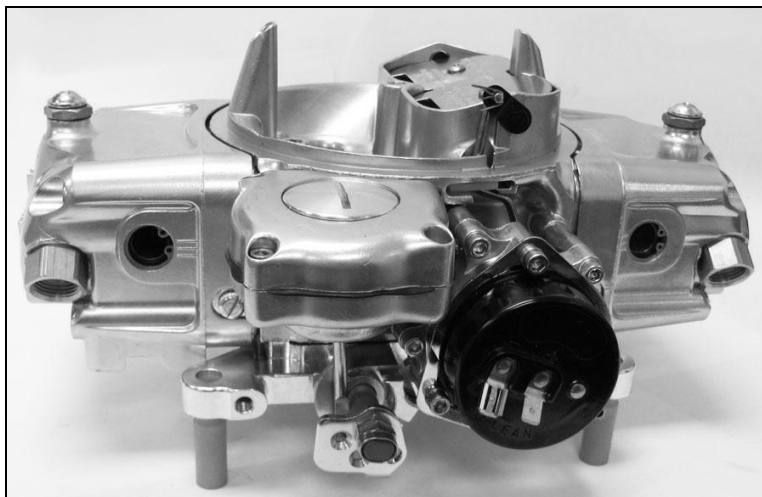

Figure 1

INSTALLATION

Checking the Baseline Adjustments

All baseline adjustments have been made at the factory during the final assembly stage of each carburetor. These settings should allow initial start and warm up of the engine. However, in order to assure safe operation, and to assist with fine tuning that will occur later, please check and make note of the following adjustments, prior to installing the carburetor on the engine.

Throttle and Accelerator Pump Linkage

1. Check the travel of the throttle linkage to be sure no damage has occurred during handling or shipping after its final assembly. The carburetor should open smoothly to wide open throttle, and return to its full closed position when the linkage is released. At wide open throttle, all butterflies should be parallel to each other, at about a 90° right angle to the baseplate gasket surface. Do not attempt to run a carburetor that opens the secondaries past full throttle, or sticks or binds at any point in its travel.
2. When the carburetor is in the closed (curb idle) position, there should be no play in the adjustment of the accelerator pump arms. The pump levers should begin compressing the pump diaphragms as soon as the linkage begins to move. Play in the pump arm linkage will delay the fuel discharge, and the result can be a stumble or hesitation as the carburetor begins to open. At wide open throttle, check to be sure that .015" to .020" travel remains in the accelerator pump linkage. If the pump diaphragms bottom out, premature wear or binding in the linkage will occur.



Figure 2

3. Slop in the linkage can be adjusted out by either tightening or loosening the lock nut. This will control the length of the compressed spring. Slightly bend the cam follower to adjust for linkage that bottoms out. Remember, it may take a balance of both cam follower and spring adjustments to get the system working best for the application. Different cam profiles are available which can alter the timing, volume, and duration of the pump shot. If pump cams are changed, it may be necessary to re-adjust the linkage.

Closed Butterfly Position

The initial setting of the closed butterfly position will vary slightly between carburetor model sizes and fuel types. Most gasoline carburetors will have the butterflies adjusted with a small length (approximately .020", looking like a square) of the idle transfer fuel slot visible below the bottom edge of the butterflies (Fig. 3).

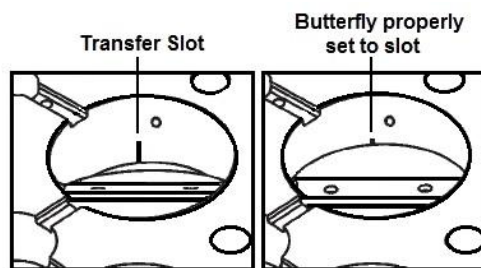

Figure 3

Primary and secondary butterflies should be open equal amounts, and never seated tightly against the throttle bores in the baseplate. If idle seems a little rich or if you cannot adjust idle speed low enough, close the secondary butterflies more than the primaries. Butterfly position is adjusted using the idle set screws in the baseplate (Fig. 4). Turn the screws clockwise to open the butterflies, or counterclockwise to close them down. Be sure to note the adjusted position of your model carburetor, as this can be important information used later during fine tuning.



Figure 4a



Figure 4b

Curb Idle Mixture Screws

The curb idle mixture screws (total of 4) are located on each side of the metering block (Fig. 5 & 6). These screws control the amount of idle fuel mixture that will be discharged into the plenum from the curb idle ports located in the baseplate. These screws have been set during wet-flow testing at the factory and it is recommended that they remain in place as delivered for initial start-up.

Keep in mind that these settings are only a starting point, and that additional fine tuning may be required once the engine has warmed up to operating temperature.

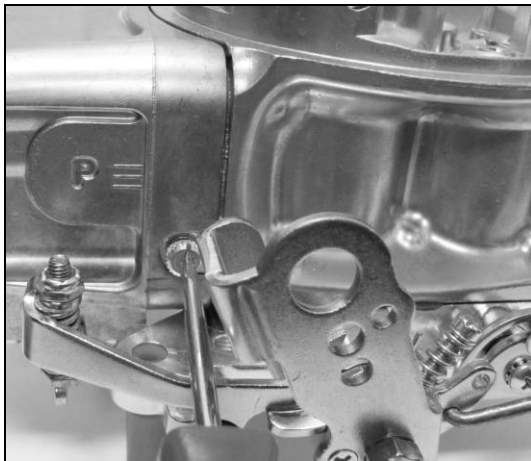

Figure 5

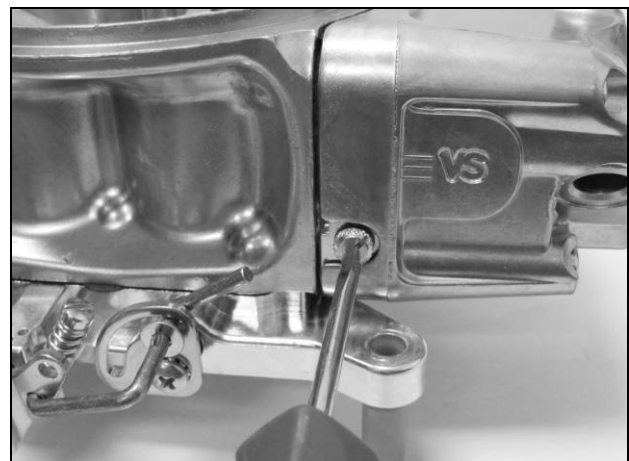

Figure 6

Bolting the Carburetor to the Manifold

After the linkage and baseline settings have been checked, the carburetor is ready to be bolted to the manifold. Be sure to use a new gasket. The carburetor should slide easily over the studs. Do not force the carburetor if it hangs on the studs. If the carburetor does hang up, check for bent or improperly installed studs. Replace the studs, if necessary. Once the carburetor is seated against the gasket, check to make sure it is sitting squarely on the mounting flange.

The carburetor should not be able to be rocked diagonally. A carburetor that rocks is an indication that the manifold or carburetor spacer could be warped. This must be corrected before the carburetor is bolted down. When the carburetor sits squarely, it is safe to install nuts and washers. Be sure all

nuts are installed on the studs and hand-tighten before beginning the final torque sequence. Use an alternating pattern to tighten each nut a little at a time. Do not over tighten the nuts. Only 5-7 foot pounds of torque are required to secure and seal the carburetor base to the manifold. Once the nuts are evenly torqued, check the carburetor linkage for smooth operation to wide open throttle, and then closed again.

WARNING: Baseplates that are cracked during installation are not covered under warranty.



Figure 7

Connecting the Throttle Linkage

Get a helper for this part of the installation. Have someone sit in the car and hold the pedal firmly against the floor. While holding the pedal firmly against the floor, pull the carburetor to its wide open position (Fig. 8). Adjust the linkage rod or cable to the proper length, and then attach it to the baseplate linkage. Remember, the pedal should come against a positive stop (the floor or an aftermarket stop), just as the carburetor gets to wide open throttle. With the linkage rod attached to the baseplate, make sure the carburetor can return to its closed position. Install your return spring(s), and check again for smooth operation to wide open throttle, and then closed again. If you rely on the baseplate linkage as a stop, it is possible to damage the linkage causing the throttle to stick in the wide open position.

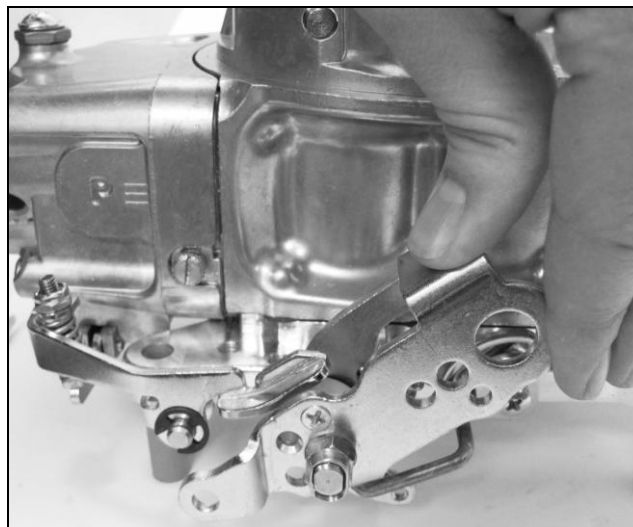

Figure 8

Connecting the Fuel Lines

Do not use thread lockers, sealing compounds, or Teflon tape on AN flare fittings. When installing fuel bowl inlet fittings, use only the sealing washers or o-rings provided with the fitting.

In most cases, a drop of oil to prevent thread galling is all that's necessary when installing pipe threaded fittings. However, if a thread sealant is used on pipe fittings, use extreme caution to prevent any tape or compound from entering the internal flow area. Remember to check for leaks when the system is under pressure. If a leak is detected, replace the malfunctioning part. When installing new fuel lines, be sure to flush the lines clear of any debris that might remain from the hose cutting or assembly process.

Demon Inlet Fittings

Demon fuel bowls feature 9/16" x 24 threaded fuel inlets and are equipped with inverted flare fittings. These fittings accept the included inlet kit (Fig. 9). The inlet fittings also retain the important fuel filter screens that are in a cavity above the fuel inlet. The screen can be accessed for cleaning by removing the inverted flare fitting.

Make sure to use a hose clamp when securing the rubber fuel line to the inlet kit.

WARNING: Always check for leaks after installing the inlet kit. Your safety depends on it!

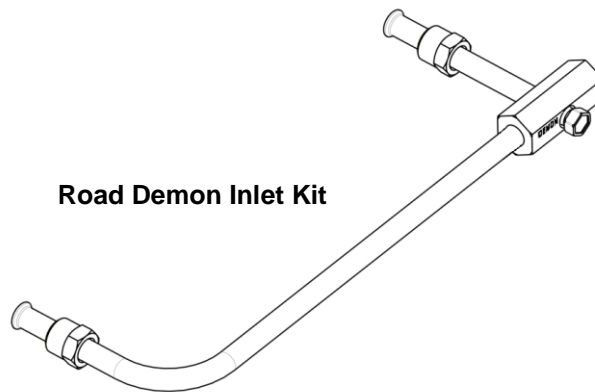

Figure 9

Vacuum Lines

All **Road Demon™** carburetors have three vacuum sources on the baseplate that can be used for PCV, distributor vacuum, diagnostics, or any other vacuum operated accessories (Fig. 10). The large fitting on the back of the baseplate, and the second fitting of the two small fittings on the side of the baseplate, are direct (below the butterfly) manifold vacuum sources. The front small fitting on the side of the baseplate, opposite the throttle linkage plate, provides a ported (above the butterfly) vacuum source. Be sure all vacuum lines are connected or plugged before you attempt to start the engine.

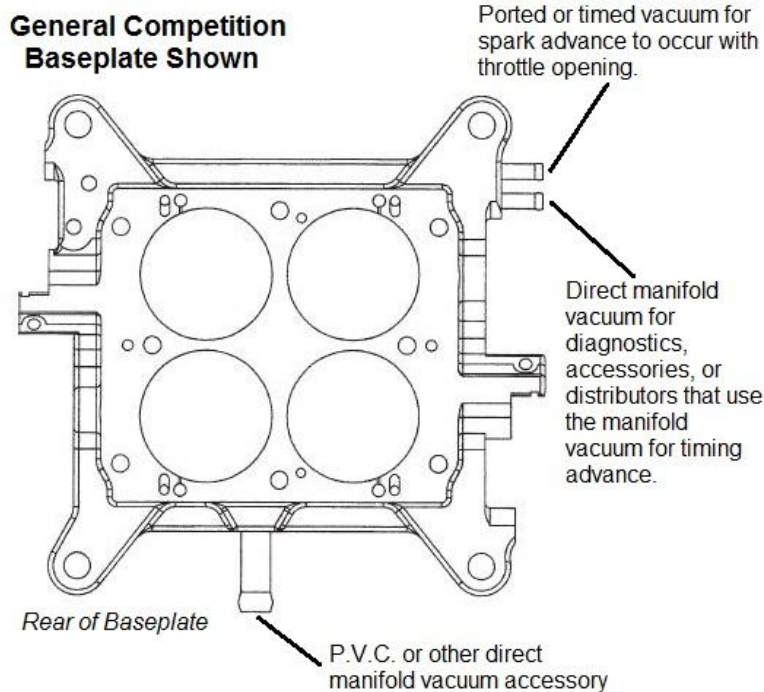

Figure 10

Priming the Carburetor

Fill the bowl through each vent tube until fuel is visible in the sight window. Depress the accelerator pump levers once or twice until fuel is discharged from the pump discharge nozzles. On vehicles equipped with electric fuel pumps, bump the pump switch on and off to fill the bowls a little at a time. Avoid an abrupt surge of fuel into an empty carburetor. This can damage the floats and cause flooding.

Remember to check for leaks. The engine should now be ready to start with a minimal amount of cold cranking.

Ladies and Gentlemen, Start Your Engines!

Get a helper. Unless your car can be started from the engine compartment, starting your engine for the first time should always be performed with an assistant. A second set of eyes to watch for fuel leaks can be invaluable. A generous amount of initial timing is also beneficial to ease starting. We find 18-24° of advance suitable for most performance applications.

Before engaging the ignition, depress the throttle fully and release once or twice. Now, attempt to start the engine. If the engine does not fire under reasonable cranking, stop cranking and repeat the

process once again. Each engine may require a different number of throttle shots to ease starting. Determine what is best for your engine.

Set the engine to a fast idle during the warm up period. If you change the adjustment of the idle speed setting screw for the warm up period, make a note of the screw setting so that it may be returned to its original position after warm up. This will prevent any drivability problems that could be caused by incorrect butterfly position.

Allow the engine to achieve normal operating temperature before attempting final adjustments to the idle speed or idle mixture settings. It is, however, acceptable to make float level or fuel pressure adjustments during the warm up period.

Preliminary Tuning and Adjustments

The following preliminary adjustments should be made prior to attempting to drive the vehicle.

Fuel Bowl / Float Level Adjustment

Although the float levels are preset during the assembly process, we recommend that they are rechecked each time the fuel bowls are removed from the carburetor. To verify the 'dry setting', simply invert the fuel bowl such that the weight of the float in the empty bowl rests against the needle and seat in the closed position. The distance between the top of the float and the inside top of the fuel bowl should measure approximately .400" to .500" (Fig. 11). A 13/32" or 7/16" drill bit is an excellent gauge for measuring this distance. Remember, this is only a provisional setting.

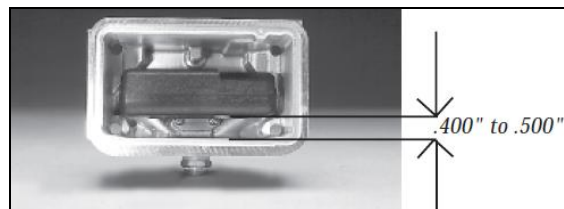

Figure 11

Final checking and adjustment must be made with the engine running and operating at the correct fuel pressure. Final fuel level adjustments can be made before the engine reaches operating temperature. A good initial setting is to have the fuel level in the middle of the sight window, as illustrated by the arrow (Fig. 12). Some combinations may require a variation from this.

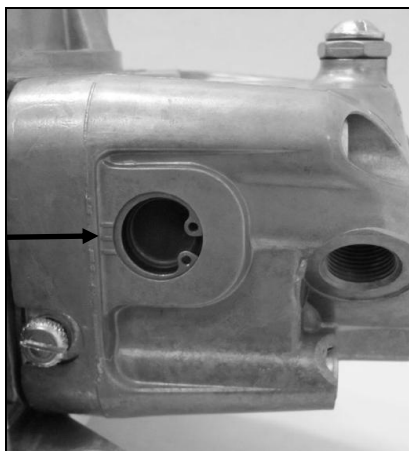

Figure 12



Figure 13

Changing the float level is accomplished by loosening the locking screw and rotating the adjuster nut on the top of the bowl (Fig. 13). To prevent fuel leakage during the course of adjustments, only loosen the locking screw enough to allow rotation of the adjuster nut. Rotating the adjuster nut clockwise will lower the float level setting; conversely, rotating the adjuster nut counter-clockwise will raise the float level setting.

It's important to note that, although increased fuel levels are immediately visible in the sight glass, lowered fuel levels are not. The excess fuel in the bowl must be consumed before the fuel level can stabilize at the new lower setting. When lowering the float levels, allow the engine to run for a few minutes, or gently rev the engine until enough fuel is used to establish the new lower setting. For this reason, setting the floats a little low (.500" or more) during the 'dry setting' procedure, then raising them to the correct operating levels with the engine running, will prevent flooding at start up. It will also shorten the time necessary to reach the correct setting. Experimenting with float settings a little above or below the startup setting is also acceptable.

Curb Idle Speed and Mixture Adjustments

Fine tuning of the idle speed and mixture must be done with the engine at or near operating temperature. A good rule of thumb is to not attempt adjustments until the engine has achieved 160° water temperature. Adjusting the engine cold will usually result in a rich mixture at normal operating temperature. It is also helpful to use a tachometer and/or a vacuum gauge for setting the idle speed and mixture.

If you have set the butterflies open for fast idle during warm up, return them to their original closed position as discussed in the preliminary set up instructions. If the engine stalls as you close the butterflies, it is usually an indication of a lean idle condition. Turn all 4 mixture screws out 1/4 to 1/2 turn from the start up setting and re-fire the engine. Also check to be sure that with the engine idling, there should be no fuel visible from the venturi boosters. If fuel is visible from the boosters, then the floats may be too high, the butterflies are still too far open, or the fuel pressure is too high. Do not attempt to correct the idle mixture until the necessary adjustments have been made to stop fuel flow from the boosters.

You may now evaluate the adjustment of the idle mixture screws. Adjusting the idle mixture usually takes two or more trips around the car. Turning the screws in (clockwise) reduces the amount of idle fuel and leans the idle mixture. Backing the screws out increases idle fuel and enriches the idle mixture.

Begin by turning each screw in 1/8 to 1/4 turn at a time. If idle speed decreases, back the screws out 1/8 to 1/4 turn. If idle speed increases, adjust them in again. Adjusting the screws to less than 1 full turn open, can result in an off idle stumble. However, some engines may respond well and not stumble with less than one turn.

The goal for best idle quality and throttle response is to have the engine idle with the butterflies closed, at the correct RPM, with the highest manifold vacuum, and the mixture screws adjusted between 1 and 2 -1/2 full turns out from fully closed. Again, your particular combination may function correctly outside of this range.

If you have any further questions concerning the tuning of your carburetor, please contact the tech staff for more information.

Complete the following steps to wire and tune the electric choke:

1. Run a wire from a switched +12V source to the connection on the pod cover marked with a (+). Run a second wire from the terminal marked (-) to a good ground. See Figure 14.

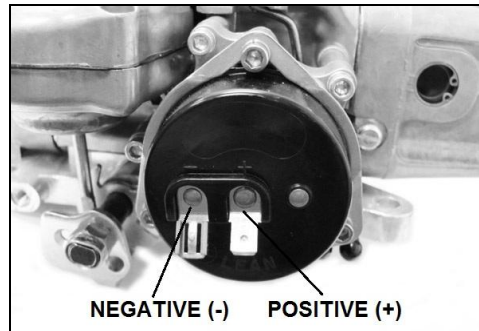

Figure 14

2. There are two primary adjustments: the choke idle speed screw and the choke timing. The choke idle speed screw controls how far the primary butterflies are open when the choke butterfly is closed or partially closed. It sets your fast idle. The screw is located on the bracket that is slipped over the throttle shaft, behind the choke pod. This idle can be increased by turning the choke idle speed screw clockwise, or decreased by turning it counterclockwise. It is important to note that when the choke butterfly is open completely (vertical up and down), the choke idle speed screw must not be holding the primary butterflies open at all. In other words, when the choke idle speed screw is in the deepest cut on the fast idle cam, it must not be hitting the fast idle cam.

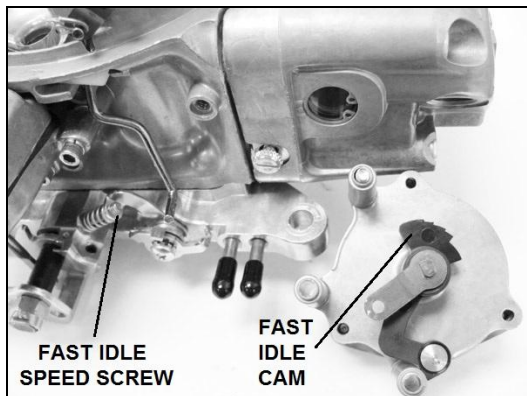

Figure 15

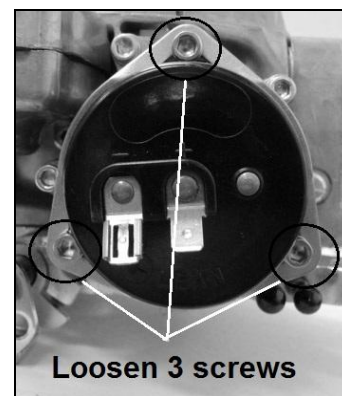

Figure 16

3. Rotating the black pod cover controls the choke timing. To rotate the cover, loosen the three Allen screws that secure the cover to the pod. (See Fig. 16) Rotating the cover clockwise will decrease the amount of time it takes the choke to pull off, while counter-clockwise will increase the time it takes. This adjustment will depend on your climate and the vehicle it is installed on.
4. One final note, dependent on which air cleaner / air cleaner gasket is used, it may be necessary to put a slight dimple into the air cleaner to allow the full range of motion of the choke shaft and butterfly. Failure to do so could result in an engine that is stuck with a high idle, which could make the vehicle hard to control and stop.

CAUTION: As with any modification, inspection of the part after completion is a must. Before use, check the linkage for freeness of operation. Your safety depends on it.

Fuel Pressure

Most gasoline powered race engines usually require between 6 and 7-1/2 PSI fuel pressure. Gasoline carburetors can be run either at idle or wide open throttle at these pressures. Be sure your fuel delivery system is properly adjusted and able to maintain volume flow at these pressures. Improperly adjusted or inadequate fuel delivery will result in poor performance and possible engine damage.

General Tuning and Component Information

Once you have completed the initial installation, and preliminary adjustments, you are now ready to test the vehicle and evaluate any other possible tuning adjustments. Information on changing the configuration or fuel metering of your Demon is also included in this section.

Metering Blocks

The metering block is the part of the carburetor having the two-fold job: controlling the flow of fuel into the venturi and mixing air and fuel prior to its introduction to the main air stream. This is done through a series of specifically sized orifices located in the metering block. These orifices will be discussed from a tuning standpoint.

The metering blocks on you Road Demon are Max-Density casting. Each block is specifically tuned for its specific application. As mentioned before, this tuning is accomplished through the various sized orifices in the block. Understanding the function of these various devices is critical to understanding how the carburetor works.

Idle Feed Restrictor

The idle feed restrictor (Fig. 17) controls the amount of fuel that enters the idle circuit from the main well. This orifice controls the amount of fuel available for the idle circuit. If all other tuning results in a lean or rich idle circuit, an adjustment here may be necessary. As with any fuel restrictor, the larger the hole in the restrictor, the more fuel that will be introduced into the idle circuit. Make small changes, .001" or .002", to all four restrictors and work towards your desired tuning point.

CAUTION: The idle feed restrictors are drilled from the factory. If they are drilled larger, you cannot go back. Modification is not recommended.

Emulsion Bleeds

There are six (6) emulsion bleeds per metering block, three (3) for each main well (Fig. 17). These orifices play a part to control the density of the fuel in the block by metering the amount of air that is introduced into the fuel in the main well. This, in conjunction with the air bleeds in the main body, help to control the shape of the fuel curve.

CAUTION: Tuning of emulsion bleeds should be performed only by those with a deep knowledge of carburetors, otherwise, a poor running engine or damaging internal engine parts could be the result.

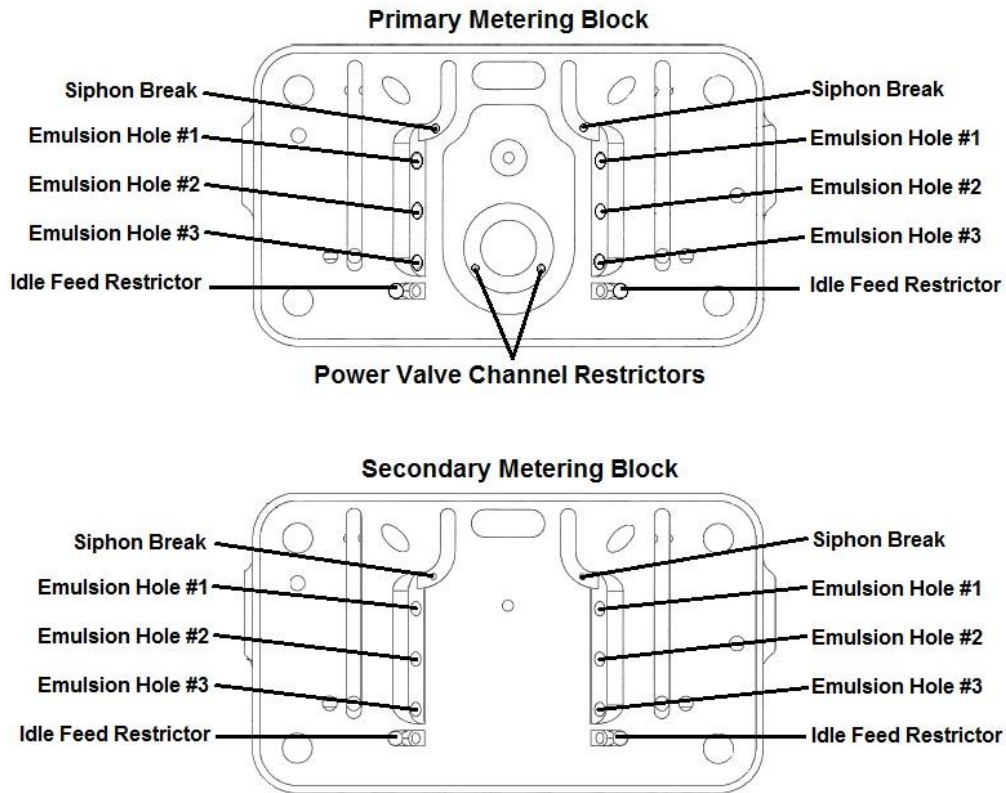

Figure 17

Main Well Jets

Main jets, located along the bottom edge of the block on the side opposite the bleeds, control the amount of fuel that enters the metering blocks, and for that matter, the amount of fuel moved by the carburetor. If the engine appears to be running rich through the entire powerband, a reduction in jet size will lean the fuel curve out. Jets are numbered, and the larger the number, the greater the amount of fuel that will be able to enter the fuel circuits.

Tuning should be done by making jet changes of a number or two, in either direction. As with any engine tuning, erring to the rich will produce less than optimal performance, whereas the same mistake to the lean can result in severe engine damage. Do not use jets to tune the idle circuit. If the idle seems too rich, return to the settings for timing, butterfly / transfer slot position, and idle mixture screws. Always, err to the rich!

Demons produce a very linear fuel curve, however it differs from the curve of other carburetors. Due to the improved atomization characteristics of the Demon, tuners with data acquisition equipment may notice brake specific numbers lower than what has become known as the "normal." A Demon with an overly rich tune-up may act excessively sluggish compared to other style carburetors. In other words, if you attempt to match "normal" brake specific numbers, you may be left with a sluggish Demon that is operating well below its potential.

Power Valves

The power valve, located in the primary metering block between the two main jets (Fig. 18), offers a boost in the available fuel to the engine in high load conditions without creating an over-rich idle or part throttle. Power valves are marked with a vacuum rating. This rating is the point at which the valve

will open. The lower the number, the more the vacuum has to drop for the valve to open. When the engine is under a big load, it produces decreased manifold vacuum along with an increased demand for fuel. When the manifold vacuum is less than the rating on the power valve, it opens and allows extra fuel to enter the main circuit of the metering block. It is a good idea to have a power valve rating that is lower in number than the vacuum produced by the engine at idle. Road Demons are supplied with a power valve blow-out protection valve in the baseplate.

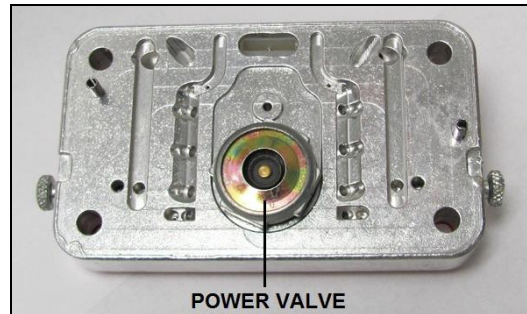

Figure 18

Main Body

The main body's unique top shape increases the air flow capacity over standard carburetor designs. The accelerator pump squirter and the air bleed bosses have been moved back to further improve flow characteristics. These changes have an effect on the overall performance of the carburetor.

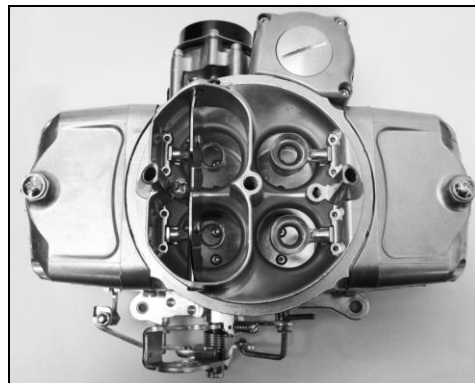

Figure 19

Air Bleeds

The air bleeds, located in the upper portion of the main body between the wall and the venturi, shape the fuel curve by helping to control when the idle and main circuits start. The four (4) idle bleeds are located closest to the air cleaner ring, while the four (4) high speed bleeds are found on either side of the squirter bosses. A larger bleed can be used to slow down, or delay, the related circuit, and vice-versa for a smaller bleed. As with the emulsion bleeds, tuning with the air bleeds should be done only by someone with a deep understanding of carburetion to prevent a poorly operating carburetor.

Squirters

The exit orifice diameter of either of the squirter controls the duration of the pump shot. The smaller the diameter, the longer it will take for the complete volume of the pump to discharge. A larger diameter discharges the pump's volume quickly. This is assuming no changes in pump cams.

Tuning the Vacuum Pod

Tuning the vacuum pod mainly involves spring changes to vary the opening rpm and rate. This is achieved by using a tuning kit such as Demon Carburetion™ **part number 120083**, which includes springs that vary in the amount of pre-load and spring rate in order to fine-tune the carburetor for every application.

The Quick-Change Pod allows for tuning with different springs without the need to remove the pod body from the carburetor main body.

1. Using a wide bladed screwdriver or a coin (Fig. 20), remove the billet disk (color may vary from picture) from the center of the pod lid. Once the disk is loose, lift the disk from the pod lid and remove the spring.
2. Please note the O-ring that seals the disk to the pod top (Fig. 21).
3. Replace with a spring selected from the chart below and reinstall the disk (Fig. 22).

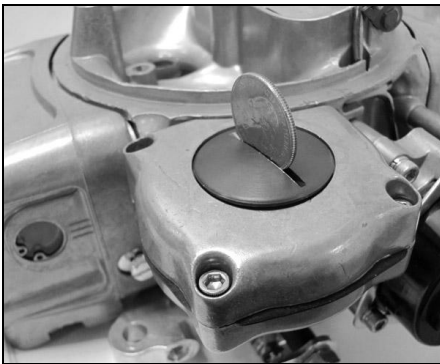

Figure 20

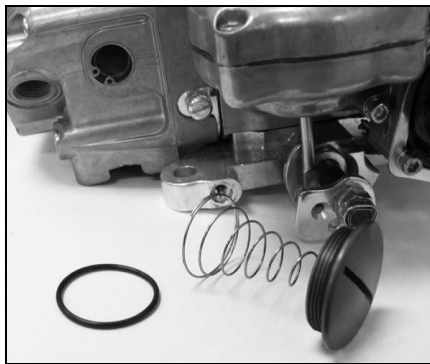

Figure 21

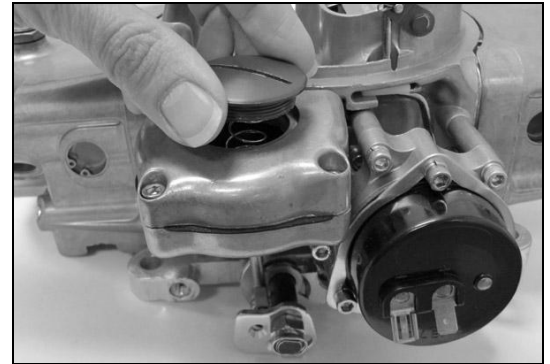

Figure 22

Spring Color	350 CID Engine		402 CID Engine	
	RPM to Open	RPM at Full Open	RPM to Open	RPM at Full Open
White	---	---	---	---
Yellow (short spring)	1620	5680	1410	4960
Yellow	1635	5750	1420	5020
Purple	1915	6950	1680	6050
Plain (std. spring)	2240	8160	1960	7130
Brown	2710	8750	2380	7650
Black	2720	Not fully open at max air flow	2390	Not fully open at max air flow

FORD KICK-DOWN LINKAGE

All new manufactured Road Demon Carburetors™ come with a Ford kick-down linkage. If running a Ford automatic and the kickdown linkage is needed, a spring and perch kit (P/N 421445) is required. Note spring mounting location on the linkage.

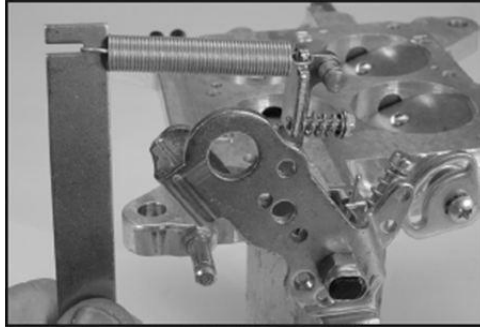

Figure 23



Return Address & Contact information:

Demon Carburetion™
1801 Russellville Road
Bowling Green, KY 42101
Ph: 270-901-3346
www.demoncarbs.com

© 2012 Demon Carburetion. All rights reserved.

LIT407

Date: 2-28-12