



DRAGON CLAW

87-96 SMALL BLOCK CHEVY 26 SPLINE

***This Kit Requires a Min. 1 5/8 in. Working Input Shaft Splines.**

***Professional Installation recommended**

***Power/Air tools NOT advised**

-
1. Inspect input shaft splines for damage or burring.
 2. Install new **pilot bearing (16)**.
 3. Install new **flywheel (1)**. Replace the factory flywheel bolts if recommended by manufacturer or if you're unsure of bolt type or condition. Torque them per shop manual. (**Caution:** Overtightening of flywheel bolts may result in crankshaft damage and oil leaks at the rear main seal.)
 4. Install **inner clutch disc (3)** and **floaters (6)**. Install with sprung hub toward the flywheel with markings "flywheel side" down towards the flywheel or markings "floater side" toward the floater. Use supplied **alignment tool (14)** to align clutch disc and keep it centered. Attach **floaters straps (5)** with **locking nuts (9)** to attached **floaters studs (7)** with **floaters stand (8)**. Torque bolts to 25 ft-lbs. (**Caution:** Double check strap alignment before torquing.)
 5. Install **flywheel stands (4)**. Install **outer disc (10)** and **cover assembly (11)**. Outer disc hub should be outward facing, away from crank and towards the transmission or markings "floater side" toward the floater and "trans side" toward transmission. Align **cover (11)** with **flywheel (1)**. Tighten 12-point 3/8" **flange nuts (12)** to 35 ft-lbs using a star pattern to draw cover down as evenly as possible.
 6. Install release bearing to proper position/adjustment using provided bearing setup tool. (Refer to Bearing Setup Tool Insert.) It is **strongly** recommended that this be set and or checked with this tool for best clutch performance.
 7. Reinstall transmission assembly taking caution not to hang transmission on the clutch disc or forcing splines into clutch disc. It is also recommended to put transmission in gear before installation. This will aid in the spline alignment by being able to turn the input shaft with the output shaft, or by slightly rocking the transmission back and forth.
 8. If hydraulic release bearing is used, fully bleed clutch system. This can be accomplished by different methods depending on the type of release bearing being used. If no bleeder is provided, start by working the pedal as many as 50 or more times until the pedal feels pressure in full stroke.

Product Insert # 199R11054
Part Number 96-103

Patented Technology:

The centrifugal lever-assist technology yields higher clamp load and torque capacity without increasing the pedal effort. How does it work? As engine RPMs increase the lever is forced to fly outward. As this happens, the lever pivots and applies direct pressure to the pressure plate. The graph below shows the patented levers increase torque capacity by 15% at peak torque RPM!

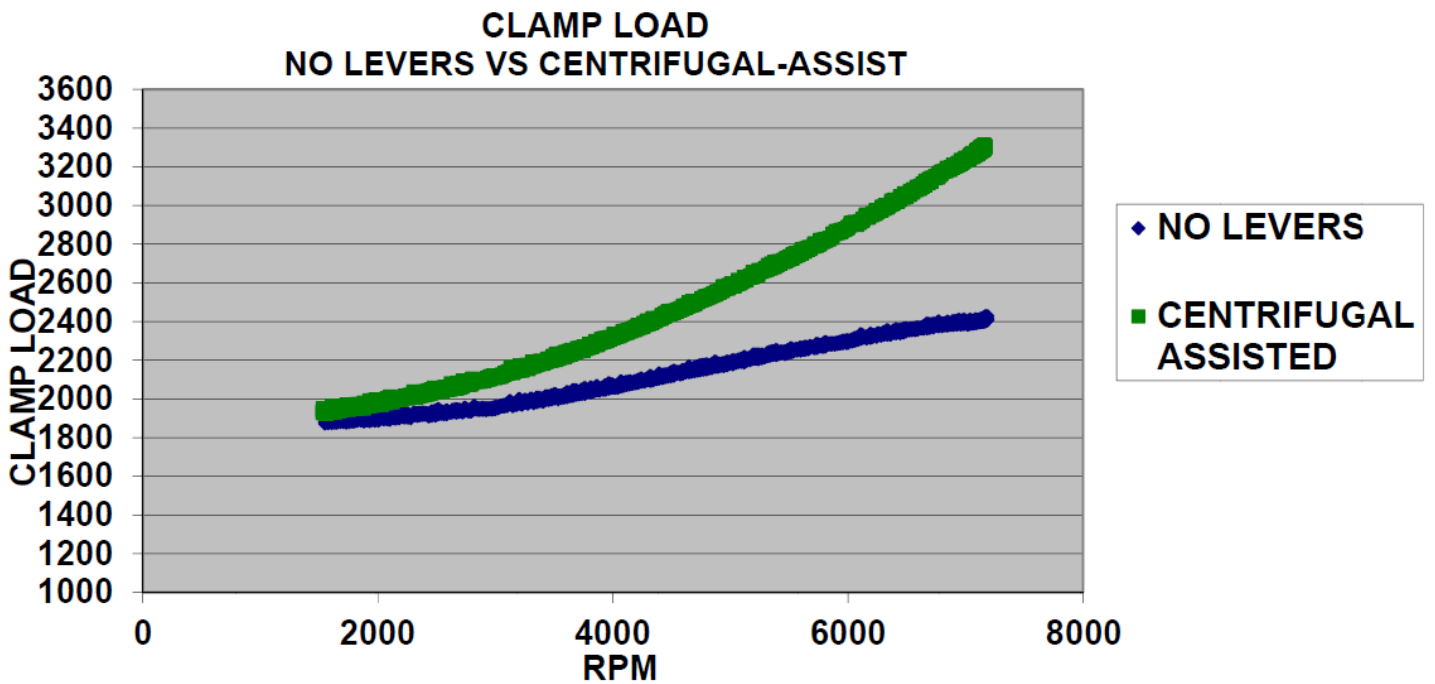
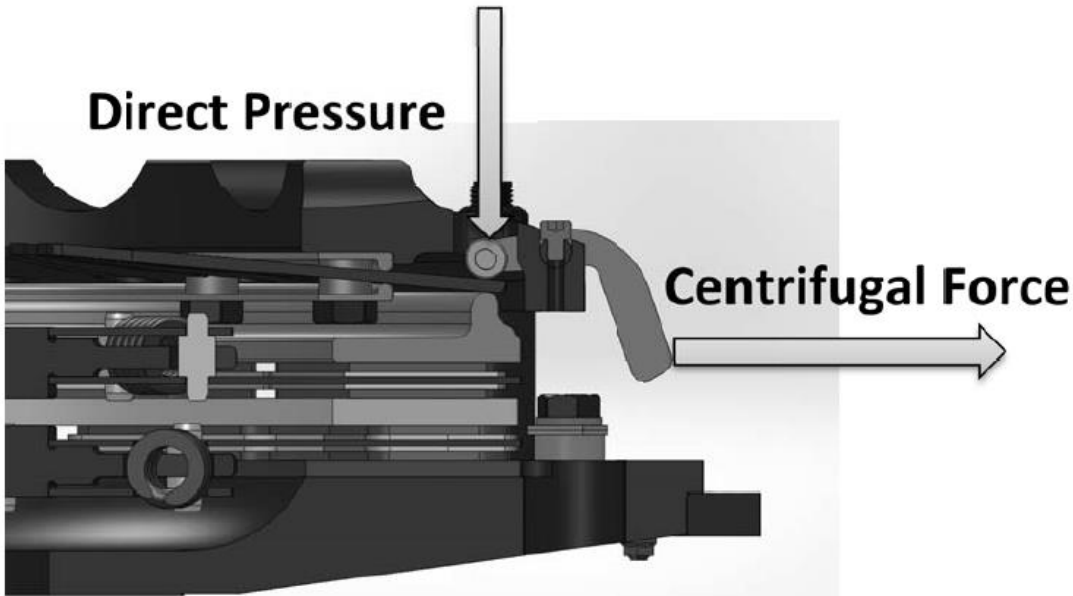

PARTS LIST					
#	Description	Qty	#	Description	Qty.
1	Flywheel	1	10	Outer Disc	1
2	Flywheel Studs	6	11	Cover/Diaphragm/Pressure Plate Assembly	1
3	Inner Disc	1	12	12 Point 3/8" Flange Nuts	6
4	Flywheel Stands	6	13	Set Screws	2
5	Floater Straps	3	14	Alignment Tool	1
6	Floater	1	15	Release Bearing Bolts	2
7	Floater Studs	3	16	Pilot Bearing	1
8	Floater Stands	3	17	Flywheel Bolts	8
9	Locking Nut	3	18	Shims	TBD*

**Number of shims to be determined by application*

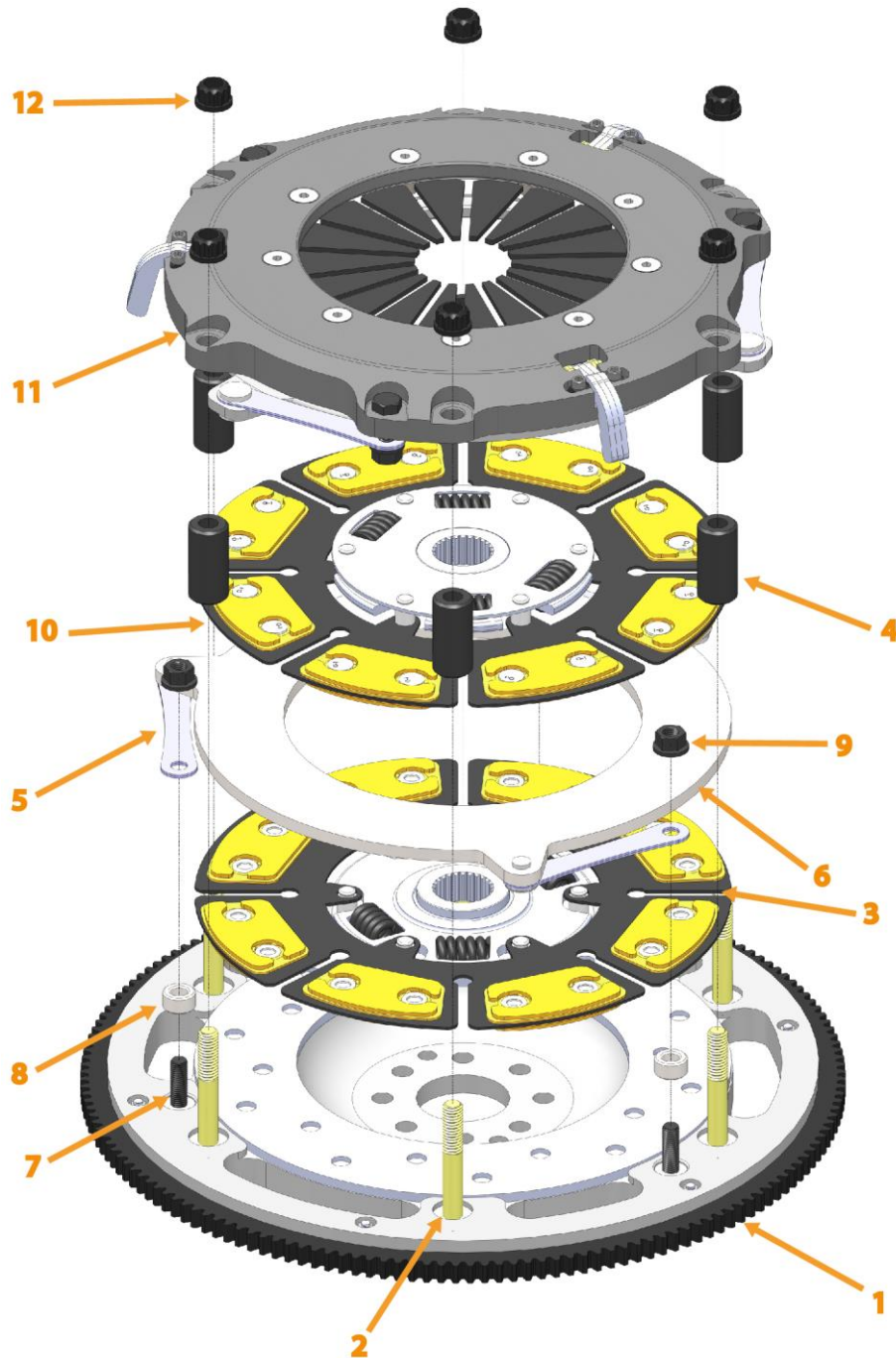

BEARING SETUP TOOL

1. With tool removed from packaging, loosen center thumb screw to allow the locator to move freely.

2. Place tool with arch opening over the installed clutch assembly resting the feet firmly against the block or the block plate where the bell housing mates against the engine. (If straight edge bar causes interference, it can be removed for additional clearance.)

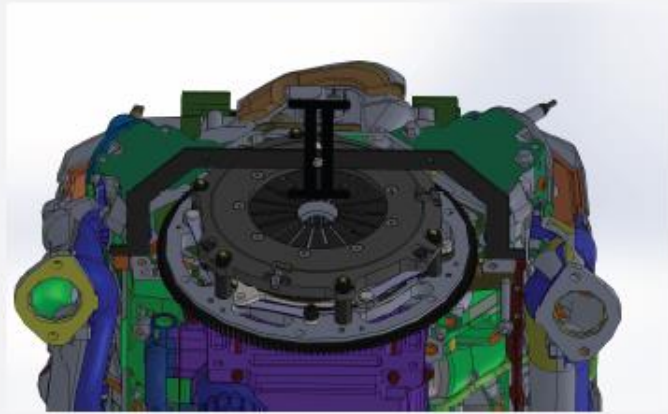

3. Slide locator toward clutch diaphragm fingers where the release bearing will ride. Tighten thumb screw.

4. Now the setup tool is set. (Reinstall straight bar if removed in Step #2.)

5. Place the straight edge bar of the tool flat across the bell housing mating surface.

6. The Flat edge of the locator is where the release bearing needs to set 0/- 1/8 inch.

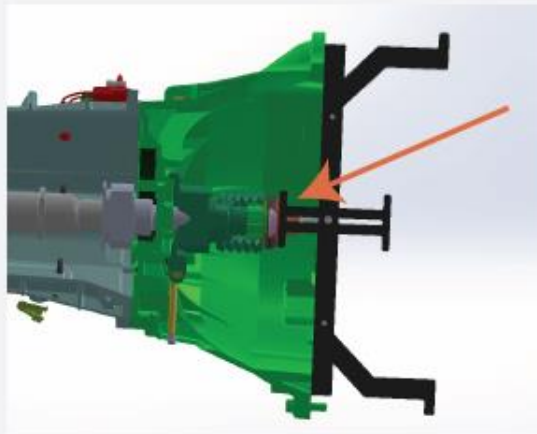

**Locate Bearing
to this Point
0/- 1/8 inch**

7. Bearing adjustment is to be determined by the type of bearing to be used per application.

BEARING SETUP TOOL

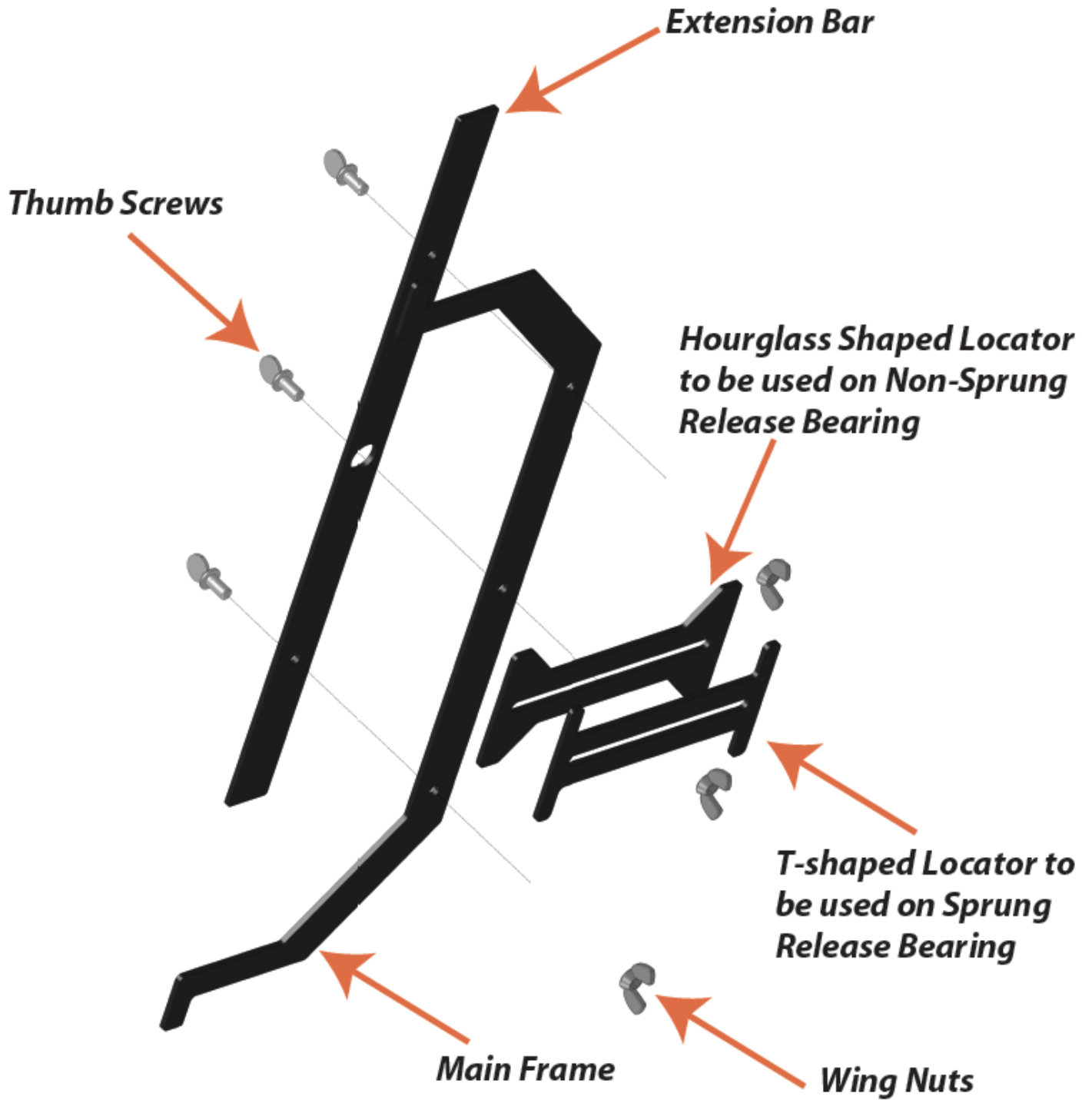

HAYS LIMITED WARRANTY

Due to the intended use of this product, warranty is limited to 90 days from the date of initial retail purchase. The product shall be free of defects in material and workmanship. Friction materials in this product are excluded. No warranty is offered for durability or specific performance because this is a consumable item. Hays is not responsible for the failure of mating components and/or other components of the driveline. Improper installation or improper application voids any warranty. If slippage occurs after installation stop use immediately and contact customer support. All products must be sent back to place of purchase for evaluation for warranty.

Clutch problems are frequently attributed to adjustment and/or release system malfunction.

*Before removal of the product for possible warranty, please refer to shop manual on operation and adjustment of the release system or proper release. The following list is common issues that are not covered under warranty.

- Worn Diaphragm fingers
- Hot spots on friction surfaces
- Lubricant on friction surfaces
- Damaged or worn friction material
- Damaged or broken disc hub and/or carrier
- Broken hub springs
- Worn bearing face
- Broken bearing seal

Hays Technical Support
1-866-464-6553