



# 7518HKR (Black), 7518-1HKR (Metallic Ceramic), 7518-3HKR (Darkside), & 7518-4HKR (Titanium) Competition Header for 1975-82 Corvette (265-400) Instruction Sheet

- NOTE:** Header dual system will not fit Turbo 400 applications.  
**NOTE:** Will not fit angle plug heads.  
**NOTE:** Header dual exhaust system fits 1975-82 only.  
**NOTE:** Will not fit with early cast iron Powerglide transmission.  
**NOTE:** If alternator/generator is mounted on the right side exhaust manifold, purchase Hooker bracket 10922HKR to reinstall (L/S use 10927HKR).  
**NOTE:** This header will not fit with the 700R4 transmission without collector modifications.

**WARNING!** Breaking in an engine with ceramic-coated headers WILL result in damage to the coating and will VOID all warranties. Ceramic-coated headers require several heat cycles to fully cure before they will withstand extreme heat. Hooker® recommends using cast iron exhaust manifolds or old headers to break in new engines to avoid coating damage. Please call tech service at 1-866-464-6553 for additional information regarding ceramic-coated exhaust products.

## **BEFORE STARTING**

Your vehicle must be raised a minimum of 36 inches. A floor hoist is ideal. If no hoist is available we strongly urge the use of axle stands as a safety measure. **CAUTION!** Your car should not be supported on a bumper jack prior to installing headers, take the time to make a careful and complete inspection of both engine and transmission mounts. Replace them if they look worn or damaged, otherwise this may affect the header fitting into your vehicle properly.

## **INSTALLATION PROCEDURE: PLEASE READ CAREFULLY**

### **LEFT SIDE**

1. Disconnect the battery cable to prevent damage to the electrical systems.
  2. Unbolt the stock headpipes (both sides) at the exhaust manifolds and remove from the vehicle.
  3. Remove the stock exhaust manifold, spark plugs, oil filter, dipstick tube, and clutch linkage (if so equipped).
  4. Starting from below, work the header up through the chassis into position over the exhaust ports.
- NOTE:** 1977 models require unbolting the power steering ram and moving it aside to install the header. Bolt the ram back in place after the header is in position.
5. Insert the gasket between the flange and head. Start the header bolts (most restricted first) and tighten evenly.
  6. Replace the spark plugs, dipstick tube, and clutch linkage (if removed).
  7. Replace the oil filter. Headers will only fit with a short-type filter. Older models will require the purchase of a screw-on adapter.
  8. If the generator/alternator was mounted on the exhaust manifold, use the purchased Hooker bracket (P/N 10927HKR) to remount. Use the (2) 1" long header bolts to attach the bracket. **See Figure A.**
- NOTE:** If the engine had a radiator reservoir canister mounted on the stock exhaust manifold, use the purchased bracket with (2) 1" long header bolts in the front holes of the flange. Attach the canister to the bracket with the stock bolts. **See Figure B.**
9. If the air conditioning compressor was mounted on the head, purchase Hooker bracket (P/N 10925HKR) to reinstall.

### **RIGHT SIDE**

1. Remove the exhaust manifold and spark plugs.
  2. Starting from below, work the header up through the chassis into position over the exhaust ports.
  3. Insert the gasket between the flange and the head. Start all header bolts (most restricted first).
  4. If the starter was removed, replace it while the header is still loose.
  5. Tighten all the header bolts evenly. Replace the spark plugs. Check the clearance between the ground cable and the R-4 pipe. Reroute, as needed.
  6. If the generator/alternator was mounted on the exhaust manifold, purchase Hooker bracket (P/N 10922HKR) to reinstall. Use (2) 1" header bolts to attach the bracket.
  7. If equipped with air conditioning and the compressor is mounted on the right side head, modify the stock bracket according to **Figure C** to remount the compressor.
- NOTE:** If the stock bracket is different from the one shown in Figure C, purchase Hooker bracket (P/N 10926HKR) to remount the compressor.
- NOTE:** 1977 models use a different type of bracket to remount the A/C compressor and stock stud. **See Figure D.**
8. To connect the collector to the headpipes, purchase a Hooker reducer kit, P/N 11030HKR.
- NOTE:** If equipped with an aluminum Powerglide automatic transmission, it may be necessary to cut the reducer and weld a sharp bend to it to clear the shift linkage (when it is in park). If further clearance is needed, dent the pipe slightly. **See Figure E.**
- NOTE:** If the vehicle had a smog air pump connected to the stock exhaust system, it will be necessary to fabricate a connector from a piece of 5/8" O.D. tubing and weld it to the collector (drill hole before welding). **See Figure F.** Cut the tubing (at a straight section) coming from the air pump. Connect this collector with a length (approx. 2") of 5/8" neoprene hose. Secure with hose clamps. **See Figure G.**
- NOTE:** Finish the performance job your headers started by adding a Hooker competition dual exhaust system. Large 2 1/4" diameter tubing is mandrel bent, not press bent. Mandrel bending maintains a consistent inside diameter for maximum flow; press bending will crush the pipe, easily reducing volume by more than 10%. Our dual exhaust system is perfect (1975-82 only) when used in conjunction with Hooker Competition Turbo (P/N 21005HKR). Purchase P/N 16521HKR for your particular application.
9. Connect the battery, start the engine, and check for leaks. Be sure that all brake lines, fuel lines, and electrical wires have sufficient clearance. Reroute, as necessary.
  10. When finished, give your car a test drive, checking carefully for any new noises. After several days of driving, retighten all the bolts.

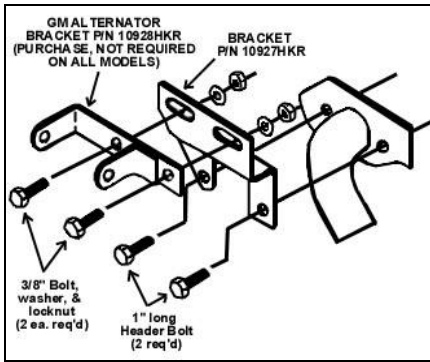

Figure A

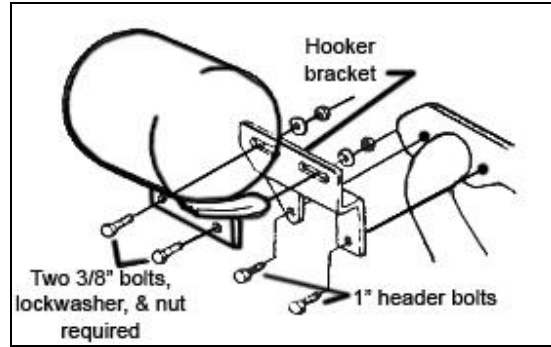

Figure B

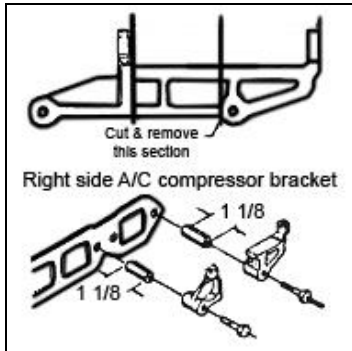

Figure C

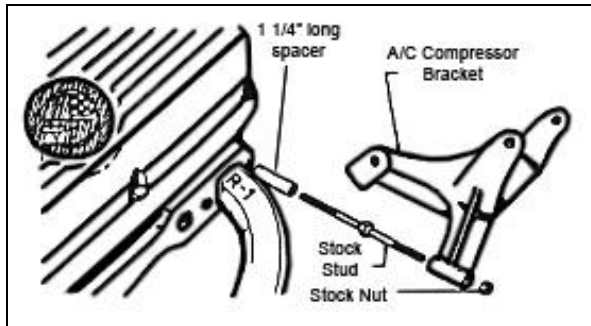

Figure D

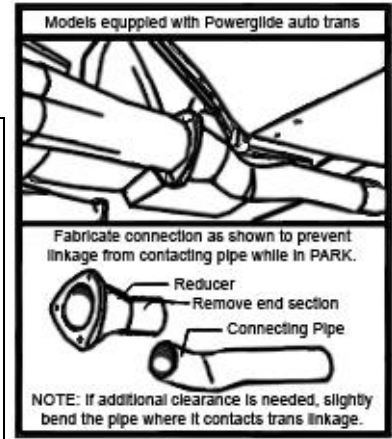

Figure E

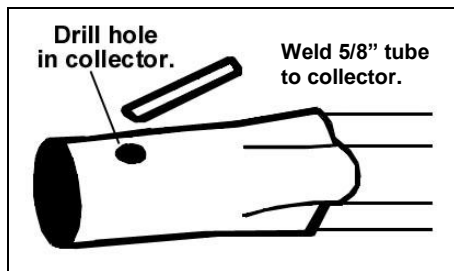

Figure F

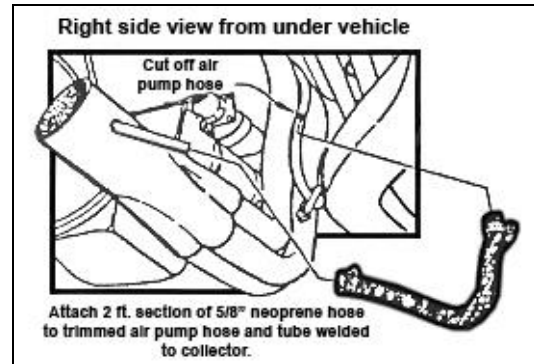

Figure G

### LIMITATION OF LIABILITY – DISCLAIMER

The regulation of emissions production, noise levels, and safety standards is undertaken by the federal government, each of the fifty state legislatures, and by many local municipalities, towns, and counties.

HOOKER Industries makes no warranties of merchantability, of fitness for particular purpose, or that its products are approved for general use, or that its products comply with laws, regulations, or ordinances in the states where they may be sold to the ultimate purchaser, the consumer. Unless expressly stated to the contrary in the catalog, instruction sheet, or price list, the entire risk as to the conformity of any company product in any such state and as to repair should the product prove to be defective or nonconforming, is on the retail purchaser, the buyer, the ultimate consumer, of such product and it is not upon the seller, distributor, or manufacturer.

In this connection, the retail purchaser, the buyer, the ultimate consumer assumes the burden of the entire cost of any and all necessary service, alterations, or repair.

**The foregoing statement limits the liability of the manufacturer.**

California vehicle code, sections 27156 and 38391, prohibits the advertising, offering for sale, or installation of any device, which modifies a vehicle's emission control system, unless exempted, unless otherwise noted. HOOKER™ Headers that have not received an Executive Order (E.O.) exemption from these code sections are not legal for sale or use in California on vehicles originally equipped with catalytic converters, except for racing vehicles, which may never be driven upon a highway. Check with your local authorities to determine if these headers are legal for use in your particular area.

### HOOKER TECHNICAL SUPPORT

Toll-Free Phone: 1-866-464-6553 & Phone: 1-270-781-9741

For online help, please refer to the Tech Service section of our website: [www.holley.com](http://www.holley.com)