

### WARNING!

If any part of this installation seems beyond your level of installation experience, please seek the help of a certified professional.

### PART NUMBERS COVERED IN INSTRUCTIONS:

2015-2017 Mustang Steering Wheel Installation	
MU950-05	Carbon Fiber Steering Wheel
MU950-06	Alcantara Steering Wheel
MU950-07	Carbon Fiber Heated Steering Wheel
MU950-08	Alcantara Heated Steering Wheel

### ITEMS INCLUDED:

- 1 Steering Wheel Core

### TOOLS NEEDED:

- 4mm Allen Key, Small Bladed Screwdriver, or Small Pin Punch
- ½" Ratchet
- 24mm socket
- T20 Torx Bit
- Plastic Pry Tool
- Silicon Grease
- Blue Loctite® or Similar Thread Locker

### BEFORE INSTALLING

Park the vehicle with the wheels in the straight forward position and the steering wheel in the 12 o'clock position.

**Disconnect the negative terminal on the battery and wait 20 minutes prior to working on vehicle to prevent any safety concerns regarding the airbag during the installation process.**



## REMOVING THE OEM STEERING WHEEL

1. Insert an Allen key or small flat screwdriver into the small hole on either side of the steering wheel referenced in **Figure 1**. Feel around with the tool until you find the spring clip circled in **Figure 2**. Press inward on the clip until the corresponding side of the airbag module is released. Repeat this process for the other side to fully release the module.
2. Release the (x2) yellow electrical connectors on the airbag module by pulling up on the orange tabs to free them as seen in **Figure 3**.

Then, release the large black connector on the upper side of the airbag module as shown in **Figure 4**. The airbag module can be set aside for later use during the reinstallation.

3. Remove the large gray connector that controls the electrical switches in the wheel seen in **Figure 5** on the next page. This connector is seated in the steering wheel core above the large 24mm hex bolt. Use a small bladed screwdriver to assist in pressing down the release tab if needed.

**NOTE:** For heated steering wheel variants, there will be a similar large gray connector to be removed below the large center hex bolt holding the steering wheel core to the steering column. This connector location is also shown on **Figure 5** on the next page.

4. Using a ratchet and 24mm socket, loosen and remove the large hex bolt (**Figure 5**) in the center of the steering wheel core. Note that this will be very tight. Once removed, the steering wheel can be pulled free from the steering column.

Be sure when removing the steering wheel core to confirm that it's in the 12 o'clock position. Lay a wide piece of tape connecting the clock spring to the column as seen in **Figure 6** on the next page to prevent the clock spring from moving and to retain function during reinstallation.

Be careful when fishing the wiring through the openings in the core to not damage them.

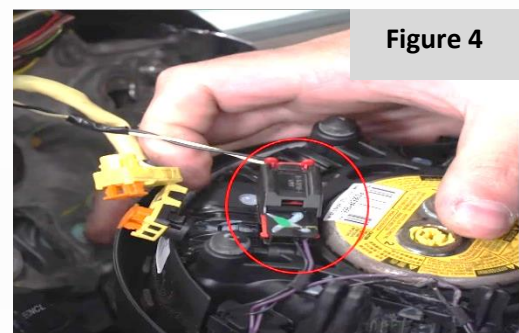
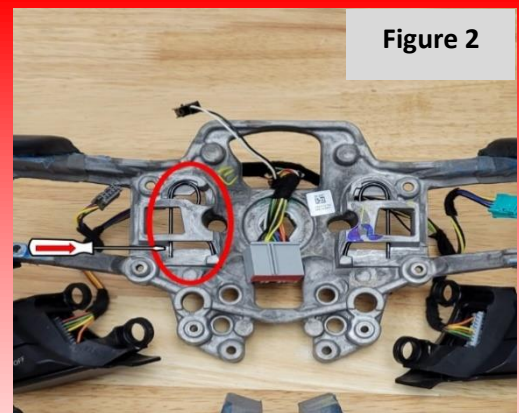
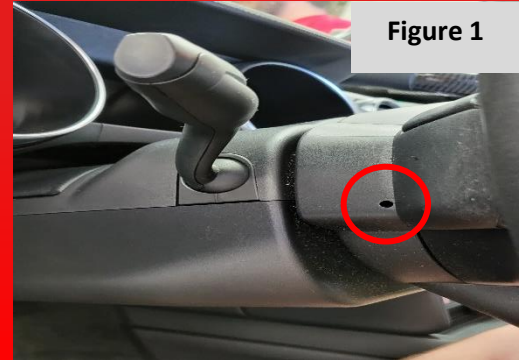

## DISASSEMBLING THE OEM STEERING WHEEL

5. Set the steering wheel core face up on a soft or protected surface to prevent any damage to the OEM steering wheel core during disassembly.
6. Using a T20 Torx bit, remove the (x6) screws as seen in **Figure 7** in the steering wheel core. Then, using a plastic pry bar, pull the upper wing bezel free from the steering wheel core on the right-hand side of the wheel from the outer wing section of the bezel prying inwards towards the center of the wheel.

*Note how the upper control mates in place with the upper shell for reassembly.*

7. Next, remove the green electrical connector on the back of the bezel by pushing down on the center tab to disconnect the connection. Then, remove the (x1) T20 Torx bit screw to release the lower section on controls on the right-hand side (**Figure 8**). Note, that the lower controls are not removed from the harness.
8. Using the same process used in *Step 6 & Step 7*, remove the controls/bezel on the opposite side of the core.
9. Remove the (x2) T20 Torx bit screws on the lower side of the steering wheel core to free the lower bezel (**Figure 9**). Use a plastic pry bar to free the bezel from the core as shown in **Figure 9**. Set this bezel aside for reinstallation.
10. Flip the steering wheel core face down and using a plastic pry bar, remove the rest of the rear shell from the assembly and set it aside for reassembly.
11. Remove the wiring harness from the OEM steering wheel core. Note how the wiring harness is looped through the steering wheel core, similar to as shown in **Figure 10**. You will need to reassemble it the same way on the aftermarket wheel. Set the harness aside for the reassembly
12. Flip the steering wheel back face up. One at a time and using a screwdriver, push the orange rubber grommets holding the steering wheel dampener onto the core off of the OEM steering wheel. The location of these grommets can be seen in **Figure 11**.

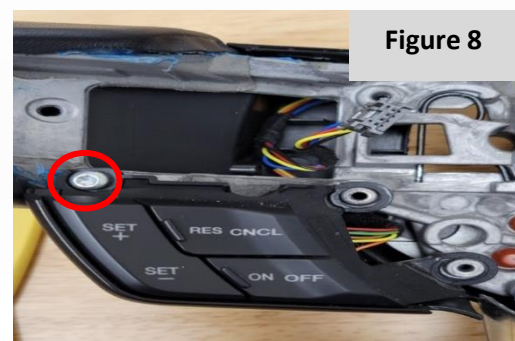
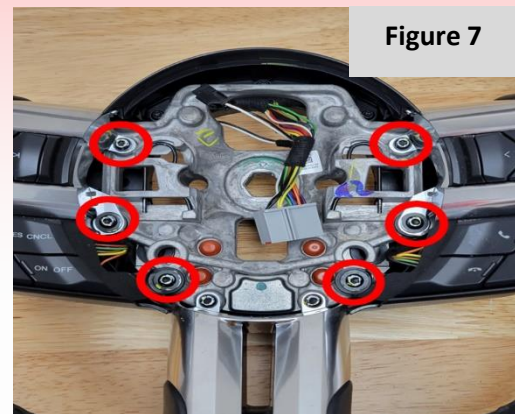
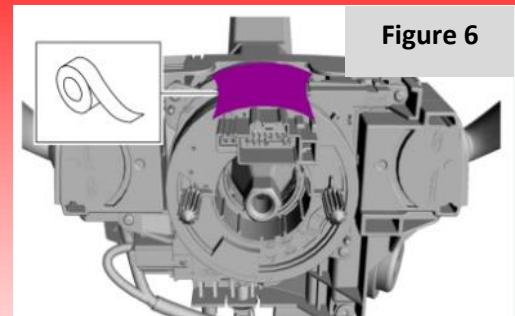
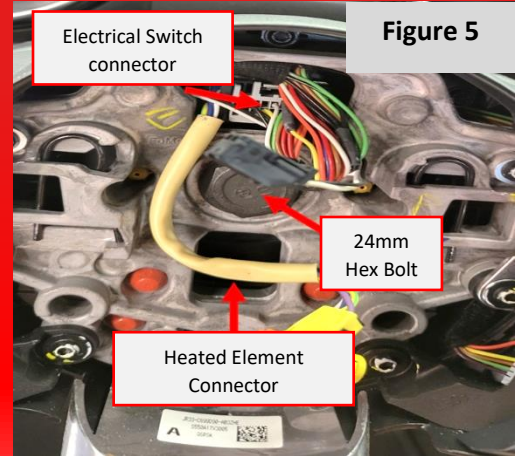

### REASSEMBLING THE AFTERMARKET STEERING WHEEL

13. Place the aftermarket steering wheel core face down on a towel or soft surface to protect from any scratches/damages.

Using an Allen wrench or pin punch, reinstall the steering wheel dampener into its corresponding holes (**Figure 11**). Using a pea sized ball of silicon grease on each grommet, press softly into the backside of the divots in the grommets until they are seated. Applying too much force may cause damage to the grommets.

14. Feed the wiring harness back through the steering wheel core (**Figure 10**). Then, reattach the rear shell to the core. A small bladed screwdriver may be needed to help guide the harness into the channels on the rear shell once assembled. Without doing so, the fitment of the shell/controls may not be tight.

15. Reinstall the V-shaped lower wing bezel onto the lower wing of the steering wheel (**Figure 9**) along with the (x2) T20 Torx bit screws. Torque to 44lb-in (5 Nm).

16. Reinstall the right- and left-hand lower controls (**Figure 8**) to the aftermarket steering wheel core. First, by reconnecting the upper switch bank connectors removed in *Step 7/8*, and then securing the lower (x1 per side) T20 Torx bit screws. Torque to 44lb-in (5 Nm).

17. Reconnect the right and left-hand multi-function controls that were removed in *Step 6/8* and **Figure 7**. Secure with (x3 per side) T20 Torx Bit screws. Torque to 44lb-in (5 Nm).

### INSTALLING THE AFTERMARKET STEERING WHEEL

18. Feed the wiring from the steering column back through the steering wheel, similar to how they came out in *Step 4*. Remove the tape on the clockspring that was installed in *Step 4* and **Figure 6** to stop the clockspring from moving during the install process.

Slide the steering wheel back onto the steering column, making sure both the steering wheel and the clock spring are in the 12 o'clock position they were removed from.

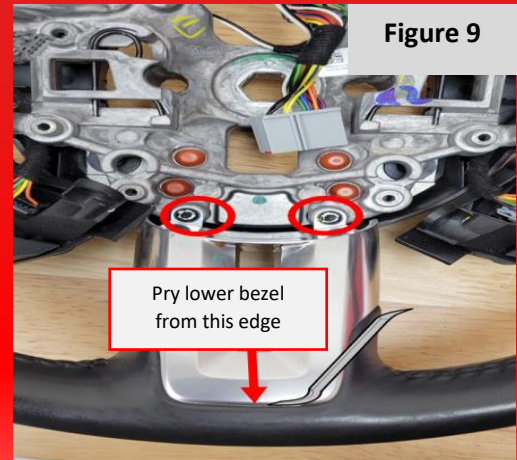

Figure 9

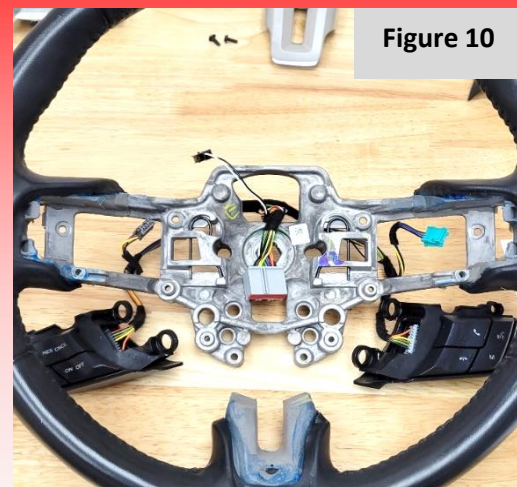

Figure 10

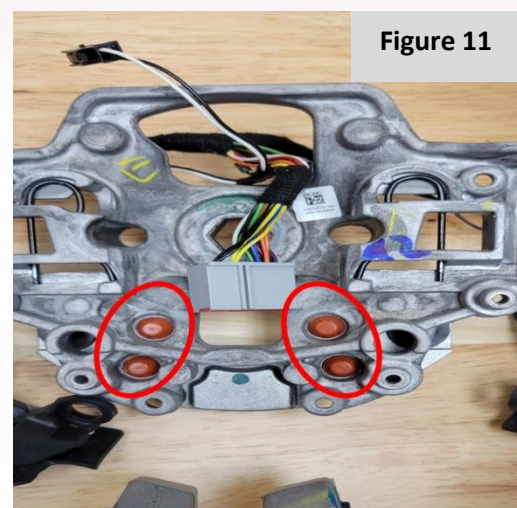

Figure 11

19. Using Blue Loctite<sup>®</sup>, or similar thread locker, reinstall the 24mm hex bolt (**Figure 5**), reconnecting the steering wheel to the steering column. Torque to 35 lb-ft. (47.5 Nm)

20. Reconnect the large gray connector that controls the electrical switches in its location as seen in **Figure 5**.

**NOTE:** For heated steering wheel variants, reconnect the other large gray heated element connector into the associated hole described in **Figure 5**.

21. Bring your airbag module up to your steering wheel, connect the long black connector (**Figure 4**) to the airbag module, followed by the (x2) yellow connectors to their appropriate color-coded locations in the module as well (**Figure 3**).

22. Finish the installation by pushing the airbag module back into the steering wheel core. An audible click should be heard to confirm insertion. Check around the circumference of the airbag module to make sure the gap is equal all around.

Reconnect your battery and confirm operation of the horn, function of electrical switch steering wheel controls, (*and heated operation if applicable*).

**Technical Support**

**Toll-Free Phone: 1-866-464-6553**

**Phone: 1-270-781-9741**

**For online help, please refer to the Tech Service section of our website: [www.holley.com](http://www.holley.com)**

© 2022 Holley Performance Products, Inc. All rights reserved. Tous Droits Réservés.

**199R12444**

**Date: 8-15-22**