



Installation Instructions Pistol-Grip Quarter Stick® Shifter

Fits: GM TH250, 350, 375 and 400 Automatic Transmissions
w/forward valve body
Catalog# 3162006

WORK SAFELY! For maximum safety, perform this installation on a clean, level surface and with the engine turned off. Place blocks or wedges in front of and behind both rear wheels to prevent movement in either direction.

CAUTION: To avoid any possibility of bodily injury or damage to vehicle, do not attempt installation until you are confident that the vehicle is safely secured and will not move.

Note: All adjustments must be made with shifter and transmission in Neutral (N). All adjustments are critical and **MUST** be precise.

Do not mix components (all parts including cable must be Hurst components provided in kit).

If a shifter is removed and reinstalled, adjustments must be checked and re-adjusted.

Always check cable for freedom of motion before connecting at shifter and transmission arm.

Routing of cable should avoid sharp bends (permanent damage of cable will result.)

IMPORTANT: Ensure that cable has adequate clearance around headers and exhaust system. Excessive heat will melt the cable liner and result in cable breakage.

Failure to comply with any of the above may result in malfunction of shifter operation. Damage to cable due to sharp bending, kinking, or excessive heat is not covered by Warranty.

These instructions detail the installation of the Hurst Quarter Stick® Shifter for GM TH250, 350, 375 and 400 with forward pattern valve body.

The shifter can be mounted directly to the floor with the four sheet metal screws supplied.

With shifter mounted in the desired location, direct eyelet end of shifter cable through shifter frame. Secure shifter cable to frame using cable clip (#4), push clip down until it is firmly seated. Put shifter in neutral and slide cable eyelet over pin on shifter stick (see exploded view), install cotter pin (#3) through hole in shifter pin to hold cable in place.

Remove stock transmission arm. Refer to the illustration for your transmission and install the proper Hurst transmission arm per the directions. Install the corresponding cable bracket per the illustration. Carefully route the shifter cable towards the cable bracket (avoid any sharp bends as cable can become permanently damaged). Insert cable eyelet through slot in mounting bracket and secure using cable clip (#4), push clip down until it is firmly seated.

Thread cable pivot (#8) onto threaded end of cable. Make sure that the transmission is in neutral. Thread cable pivot in or out on the cable until it lines up directly with the hole in the transmission arm. Lock cable pivot in this position with the 10/32 nut supplied on the shifter cable. Insert cable pivot into hole in transmission arm. Carefully shift through each gear (up and down) and check for free entry of cable pivot into transmission arm at each gear position. Re-adjust if necessary to insure proper engagement in each gear. When satisfied with adjustment, secure cable pivot to transmission using supplied cotter pin (#9).

Route cable in transmission tunnel so as to avoid binding or kinking of the cable. Make sure that the cable is not too close to or in contact with the exhaust system. When you are satisfied with the routing, secure the cable to the chassis using the supplied cable clamps (#5). Drill a 1/4" hole in the tunnel or frame, fold clamp around cable and push the split end through the 1/4" hole. Push the pointed end into the split end until it snaps tight.

ALIGNMENT PROCEDURE

- 1 Position shifter stick at "N" (Neutral)
- 2 Position transmission arm at "N" (Neutral)
- 3 Adjust cable as directed in text which appears on this page
- 4 Fasten cable end on pin with cotter pin.

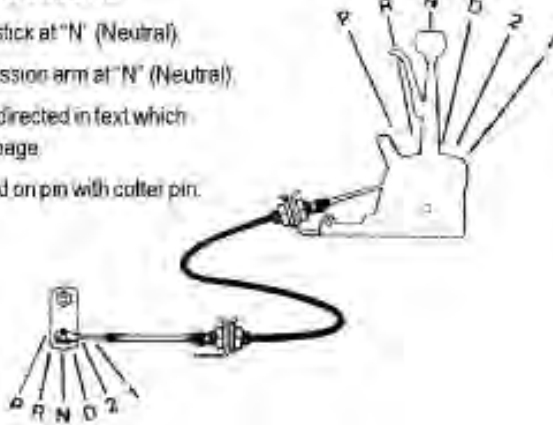

ATTACH CABLE END TO PIN ON SHIFTER STICK

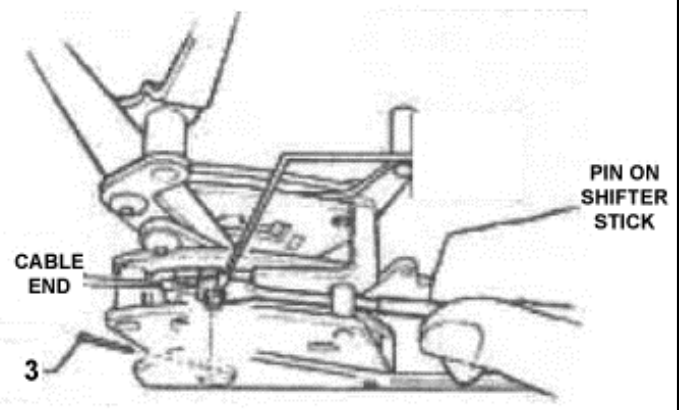

SHIFTING PATTERN - FORWARD VALVE BODY

Lockplate opening shown

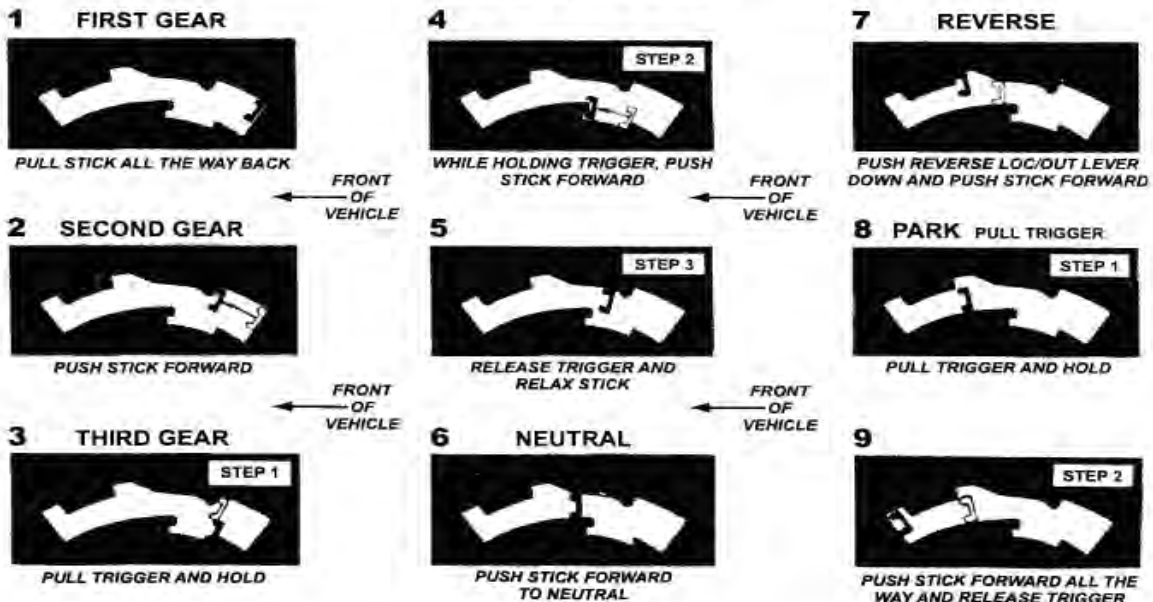

GM INSTALLATIONS

All GM installations use this bracket (1174778). Refer to drawings below for method of fastening.



Transmission Cable Bracket
Part No. 117 4778

13 11

400 TURBO-HYDRAMATIC

Use stock bolts to fasten end holes of bracket to transmission



350 TURBO-HYDRAMATIC

Install bracket with 5/16-18 x 3/4" socket head cap screw (#11) located at rear of center slot in bracket (bracket forward as far as possible). Use stock pan bolt in front slotted hole of bracket

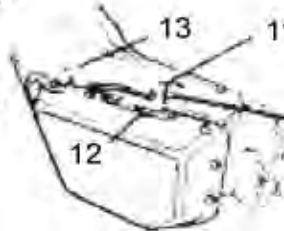

200 TURBO-HYDRAMATIC

Install bracket with 5/16-18 x 3/4" socket head cap screw (#11) located in the middle of the center slot in bracket. Use stock pan bolt in front slotted hole of bracket. Adjust in either direction for proper neutral alignment.

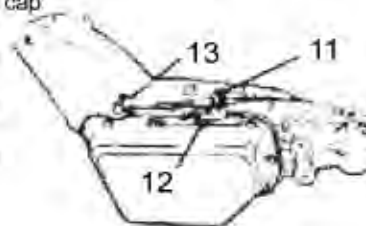

Neutral/Park Start Safety Switch Electrical Wiring Instructions

1. Vehicle must have engine off, parking brake securely engaged, wheels blocked, with transmission and shifter in the neutral position before attempting switch wiring hookup.
2. Install the supplied female crimp terminals to two suitable lengths of wire, use at least 16 gauge wire for this installation.
3. Plug each female connector onto the spade terminals of the micro switch located in the plastic switch housing.
4. Using the wiring diagram below as a guideline, install the switch wires into your starting circuit.
5. With shifter and transmission in neutral, check to see that engine starts. Repeat this with the shifter and transmission in the park position. If necessary, loosen the screw on the adjusting collar located near the shifter handle and adjust slide mechanism back and forth until vehicle starts in neutral and park only.

NEUTRAL/PARK SWITCH WIRING DIAGRAM (GENERAL)

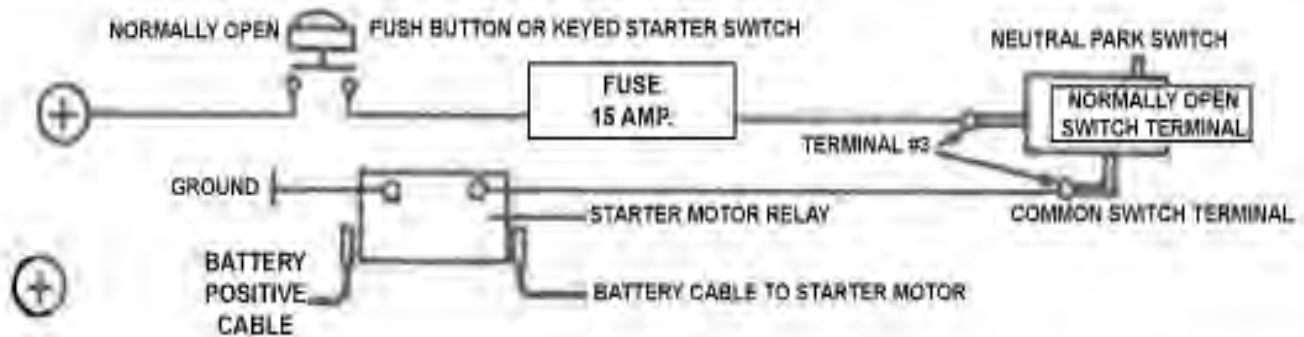

Pistol-Grip Roll/Control Switch

The Pistol-Grip Quarter Stick® shifters come equipped with a precision, snap-action, 12 volt switch that is ideal for operating the Hurst Roll/Control, nitrous oxide systems, trans. brakes, etc. It is normally open, momentary contact, quick release with a maximum 10amp. rating.

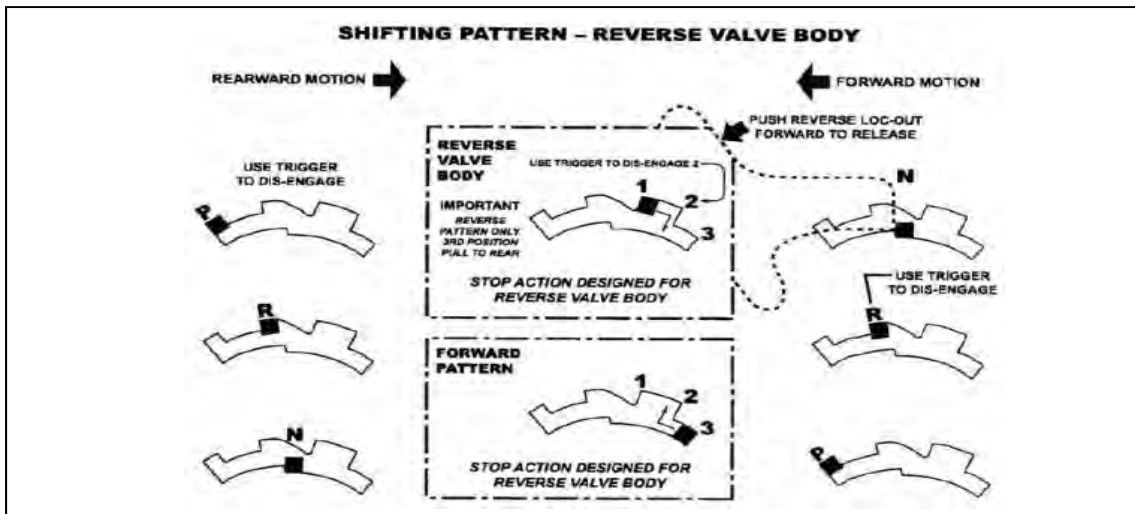

IMPORTANT: RETAIN THESE INSTRUCTIONS FOR FUTURE REFERENCE

Technical Service

A highly trained technical service department is maintained by Hurst Performance to answer your technical questions, provide additional product information and offer various recommendations.

Technical service calls, correspondence, and warranty questions should be directed to:



Hurst Performance Products

(707) 544-4761

www.Hurst-Shifters.com