



**INSTALLATION INSTRUCTIONS**  
**Part No. 40507**  
**BRACKET & LEVER KIT FOR**  
**FORD AODE & 4R70W TRANSMISSIONS**  
**and B&M 3-SPEED, REAR-CABLE-EXIT SHIFTERS**

**INTRODUCTION**

This bracket and lever kit allows the use of B&M 3-speed, rear-cable-exit shifter with Ford AODE and 4R70W transmissions.

**NOTE:** Although the AODE and 4R70W are 4-speed transmissions, they have only three forward shifter positions, so a 3-speed shifter must be used.

**Before starting, take the time to read and understand these instructions.**

**NOTES**

- It is necessary to drain the transmission fluid and drop the pan to install the new selector lever. You will need 7-10 quarts of transmission fluid (depending on pan depth), and a new pan gasket. A new transmission filter is also recommended.
- Installation requires better-than-average mechanical knowledge and skills. If this job is beyond your abilities, seek the services of a qualified technician.
- If you do not understand any part of these instructions, please call **B&M Technical Support** at **(866) 464-6553** for assistance.
- The instruction photos show a transmission on a work stand, not installed in a vehicle.

**SAFETY WARNINGS**

- **WORK SAFELY!** For maximum safety, perform this installation on a clean, level surface, with the engine turned off. Chock the wheels to prevent vehicle movement. To avoid bodily injury or vehicle damage, do not begin work until you are confident that the vehicle is safely secured and will not move.
- **AVOID SERIOUS INJURY OR DEATH BY CRUSHING!** If you have to raise the vehicle to work under it, securely support it on a lift or jack stands. **NEVER work under a vehicle that is supported only by jacks!**

**PARTS LIST**



DESCRIPTION	QTY
SELECTOR SHAFT, AODE/4R70W	1
SELECTOR LEVER, AODE/4R70W	1
BRACKET, CABLE, AODE/4R70W, REAR EXIT	1
SWIVEL, CABLE	1
PIN, COTTER 1/16" x 1"	1
SPACER, 7/16" I.D. x 1/4" L	2
BOLT, M8-1.25 x 25	2
BOLT, M10-1.5 x 20	1
WASHER, M10	1

**INSTALLATION**

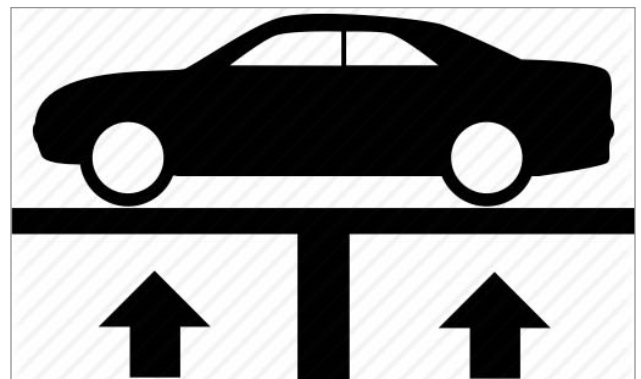

1. **Raise the vehicle up to a suitable working height** using either a lift, or a jack and jack stands. Disconnect the shift linkage from the selector lever.

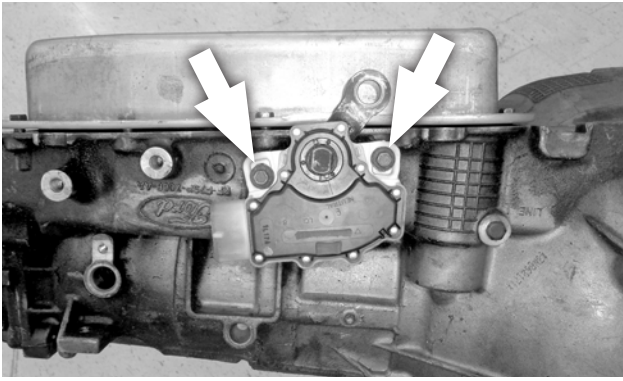

2. Note the orientation of the selector position sensor on the transmission (whether upward or downward). Remove the electrical connector from the sensor, then remove the sensor from the transmission (2 screws).

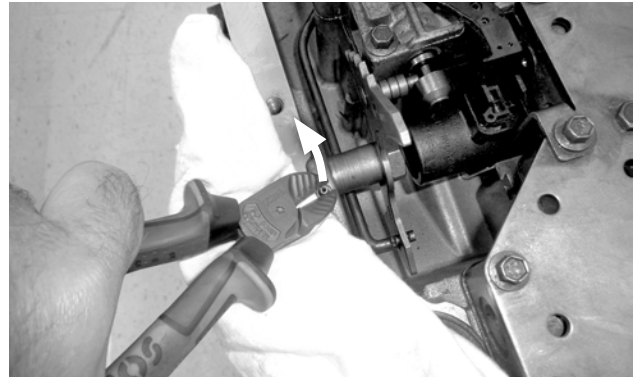

5. Protect the case flange with a rag, and use diagonal cutters to remove the selector shaft retaining pin from the case.

**CAUTION:** Work the diagonal cutters against the case for leverage. Do not cut the pin!

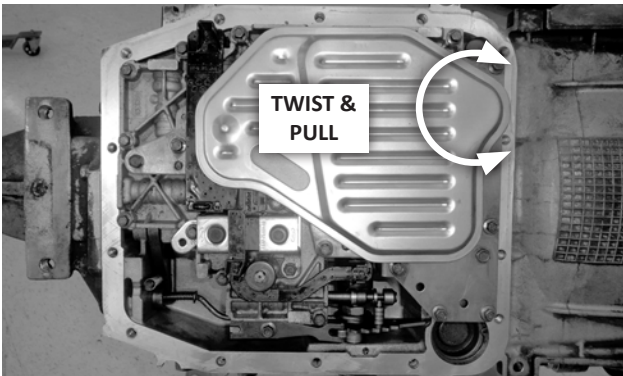

3. Drain and remove the transmission oil pan (14 bolts). Then remove the filter by using both hands to twist and pull it away from the transmission.

**NOTES:**

- If the filter grommet remains in the valve body bore, carefully pry it out with a small screwdriver. **Avoid damaging the bore.**
- If your oil pan does not have a drain plug, consider installing B&M Drain Plug Kit 80250 for quicker, cleaner fluid servicing.

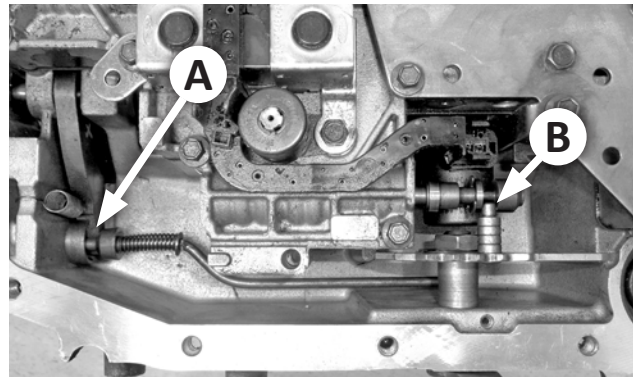

6. Before removing the selector lever (next step), note the following for reassembly:

- A. the end of the park operating rod is inserted in the case opening behind the park pawl; and
- B. the inner selector lever's engagement with the selector valve.

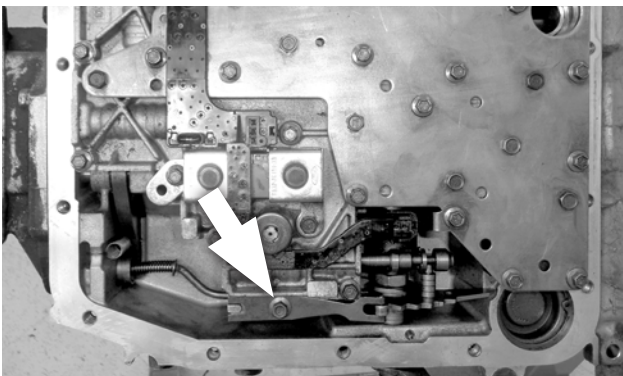

4. Remove the detent spring (1 screw).

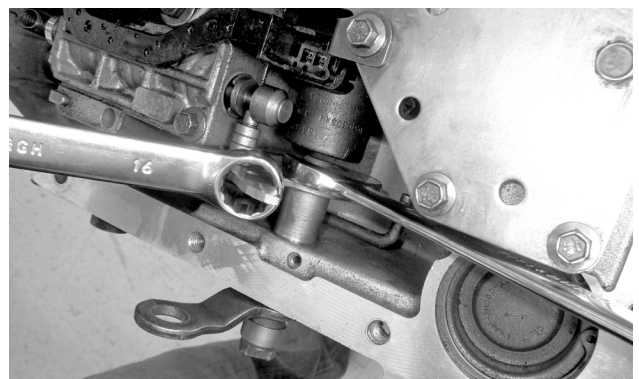

7. Loosen the selector shaft nut with a 21mm wrench, and a smaller box wrench hooked over the inner selector lever.

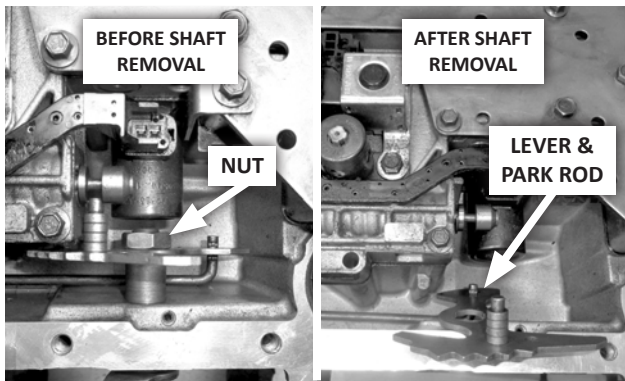

8. Pull the selector shaft out of the case, leaving the inner selector lever and park rod in place.

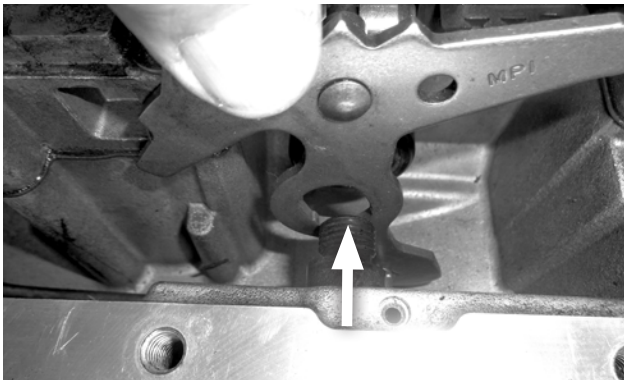

9. Lubricate the B&M selector shaft and the shaft seal (in the transmission case) with transmission fluid, and insert the shaft in the case. Align the flats on the end of the shaft with the flats in the inner selector lever, and insert the end of the shaft into the lever.

**NOTE:** When installing the selector shaft, verify park rod insertion, and selector lever-to-valve engagement, as noted at **Step 6**.

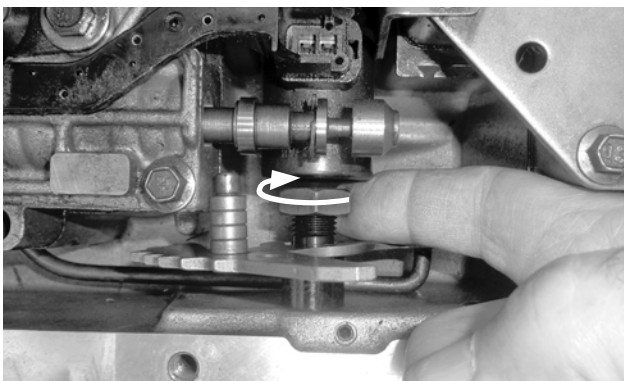

10. Thread the nut onto the selector shaft, being mindful of the park rod, and the selector lever and valve.

**CAUTION:** When fully inserted, the retaining pin protrudes about 1/8" above the case. **Do not drive the pin flush to the case!**

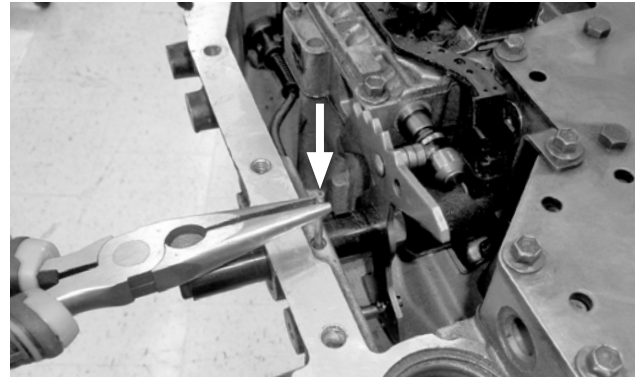

11. Carefully reinstall the retaining pin, engaging the selector shaft groove and the pin, and gently tapping the pin into place. Then tighten the selector shaft nut.

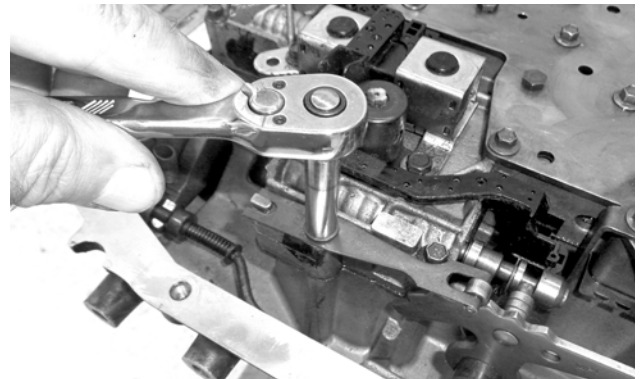

12. Install the detent spring (1 screw).

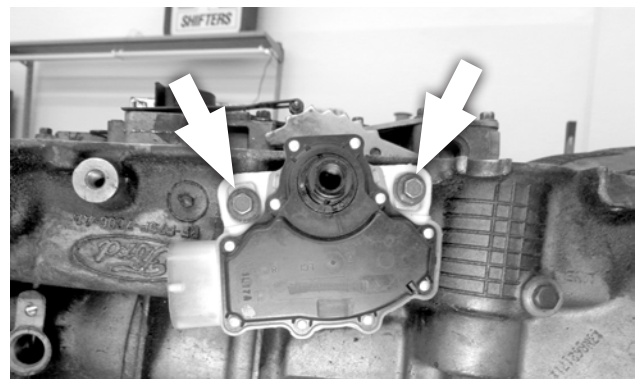

13. Orient the selector position sensor the same way as when it was when removed, align the rib(s) in the sensor bore with the slot(s) on the selector shaft, and install the sensor (2 screws).

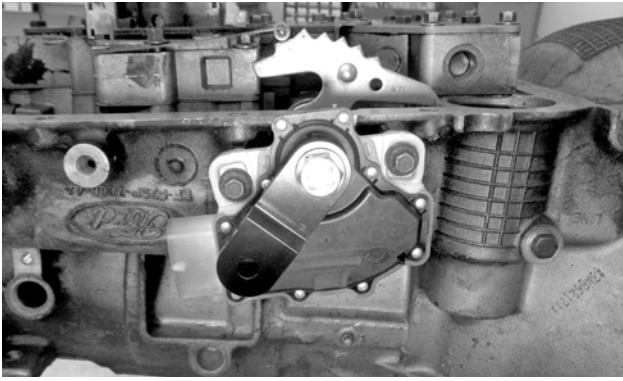

14. Install the selector lever on the shaft, using the supplied M10-1.5 x 20 bolt and M10 washer.

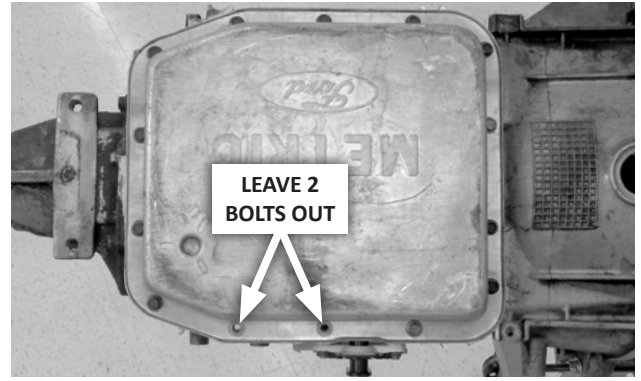

17. Install the pan and new gasket using 12 of the 14 the original bolts. (Do not tighten yet.) Leave out the 2 bolts behind the selector lever for the cable bracket.

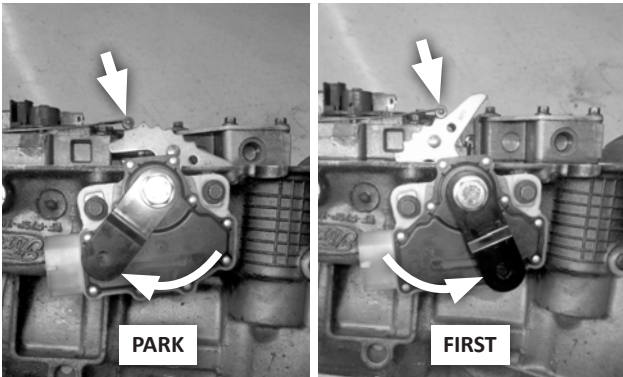

15. Verify that the selector lever moves freely through all positions, and that the park operating rod moves with it.

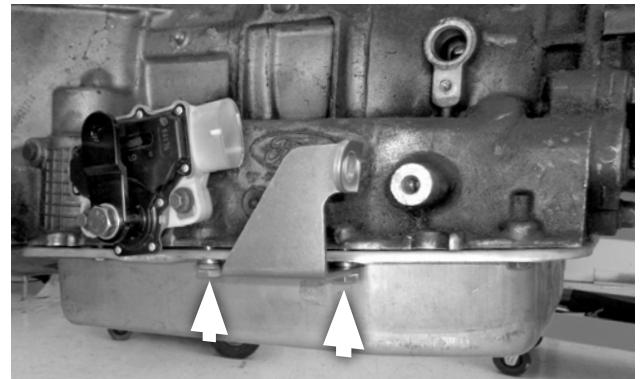

18. Install the cable bracket with the 2 supplied M8-1.25 x 25 bolts. For sheet-metal pans, use the 2 spacers between the pan and bracket. (Spacers are not used with cast aluminum pans.) Tighten all pan bolts to 12-16 ft-lbs.

**CAUTION:** Do not over-tighten the bolts, or the pan gasket may be damaged.

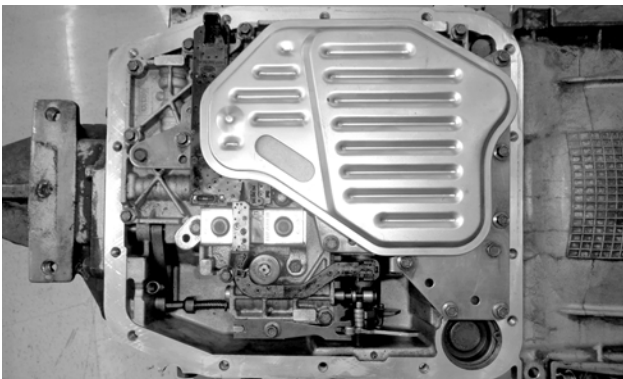

16. Install the oil filter.

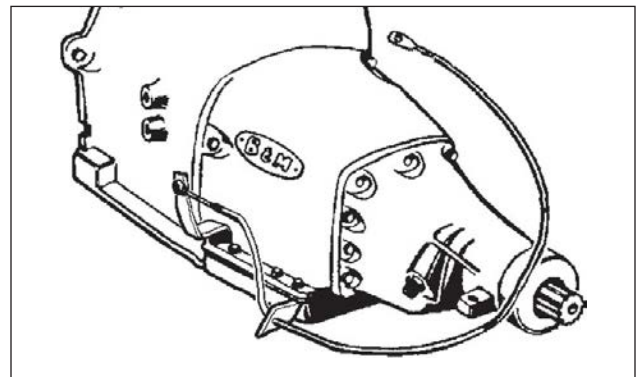

19. Route the shifter cable from the shifter to the transmission according to the shifter's instructions.

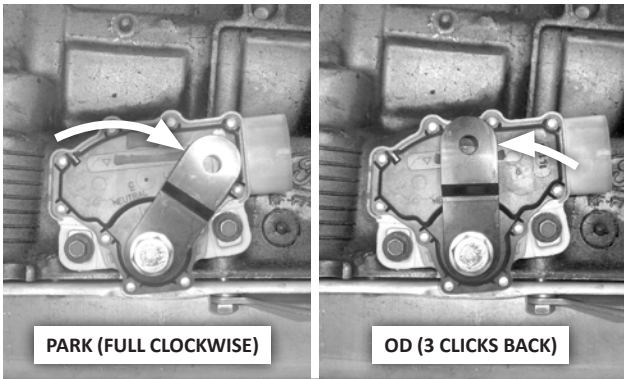

20. Move the selector lever to PARK (fully clockwise), then move it to OD (3 clicks back).

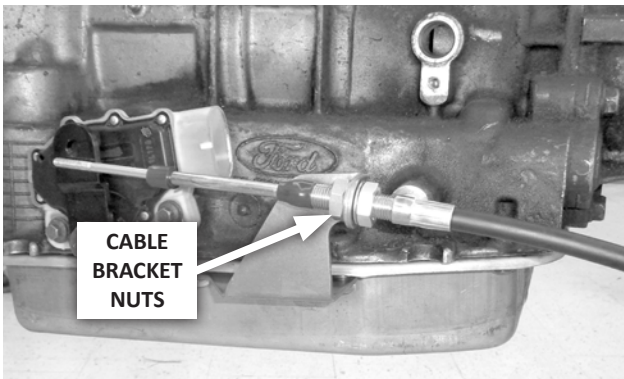

21. Attach the shifter cable to the cable bracket. First remove the small jam nut, both plastic dust boots, and one large nut and lock washer, from the cable. Then insert the cable through the cable bracket, reinstall the lock washer and nut (loosely, to allow room for adjustment), and reinstall the dust boots.

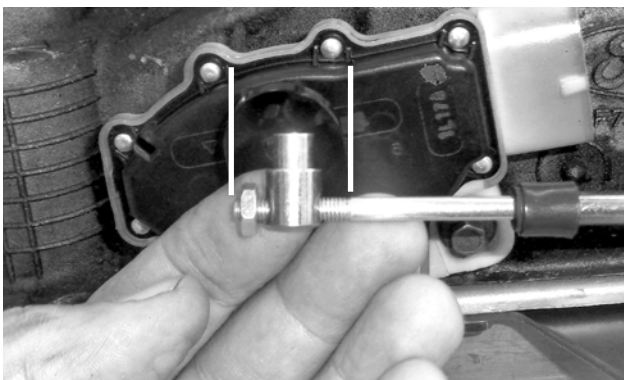

22. Thread the swivel onto the cable to about the middle of the threaded section, then reinstall (but do not yet tighten) the jam nut.

23. Adjust the shifter cable as described below.

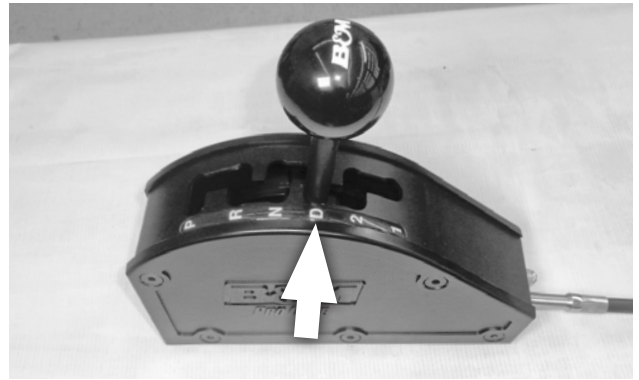

A. With the selector lever still in OD (from Step 20) and the shifter in DRIVE (or 3), adjust the cable bracket nuts (and swivel, if necessary) until the swivel slips freely in and out of the selector lever hole.

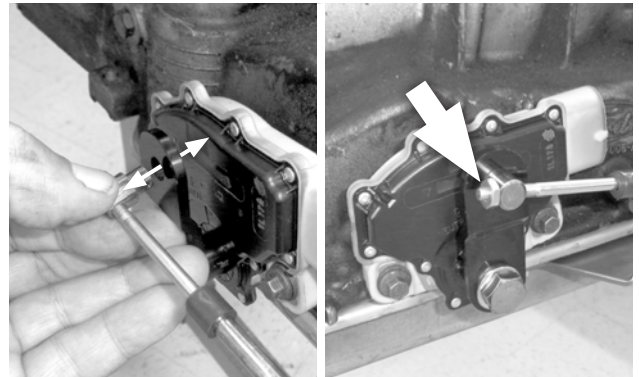

B. Gradually tighten the cable nuts against the bracket while continuing to check the fit of the swivel in the selector lever. Then with the swivel inserted in the selector lever, lightly snug the jam nut.

C. With the swivel still in the selector lever, move the shifter to NEUTRAL, and check the fit of the swivel in the selector lever. The swivel should slip freely in and out of the hole. If not, adjust the cable bracket nuts (and swivel, if necessary) per Step B.

D. Repeat for both SECOND and REVERSE gears.

E. Move the shifter to FIRST, and check the fit of the swivel. There may be a slight drag in FIRST. This is normal; do not adjust the cable.

**CAUTION:** If you encounter restricted movement or any other problem during this process, DO NOT FORCE THE SHIFTER. Doing so may damage the cable, the shifter and / or the transmission. Simply return to Step A and re-check each step.

24. **The cable is correctly adjusted** when the swivel slips freely in and out of the lever in REVERSE through SECOND gears, with a possible slight drag in FIRST. Verify that the two cable bracket nuts, and the cable swivel jam nut, are tight. Also verify that the vehicle does not roll with the transmission in PARK.

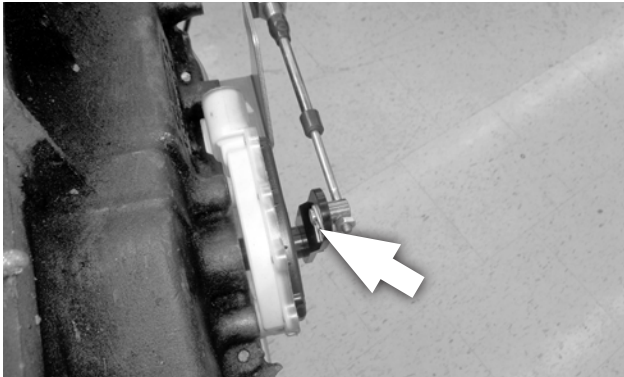

25. **Secure the swivel to the selector lever with the cotter pin.** Operate the shifter through all the gear positions, verifying that it operates correctly.

---

## SERVICE TRANSMISSION WITH FLUID

**CAUTION: Avoid foaming and overheating!** Do not overfill!

1. With the vehicle sitting on level ground, add 5 quarts of **B&M Trick Shift**, or your transmission's specified fluid .
2. Start the engine, and run the shifter slowly through its entire range and back. With the engine still running and the shifter in NEUTRAL, check the fluid level. Also check for pan leaks.
3. Each time you add fluid, run the shifter slowly through its entire range, then recheck the fluid level with the engine running and shifter in NEUTRAL.
4. Add fluid as needed to bring the level to the COLD LOW mark on the dipstick.
5. Take the vehicle for a short drive (5-10 mins.) to bring the transmission up to operating temperature.
6. Stop the vehicle on level ground, and run the shifter slowly through the entire gear range.
7. Fluid level should be between the HOT LOW and HOT FULL marks with the transmission at operating temperature, the vehicle on level ground, the engine running, and the shifter in NEUTRAL.

8. If not, gradually add fluid, run the shifter through its range, and recheck until the fluid level is between the HOT LOW and HOT FULL marks. Also check for pan leaks.

---

## OPERATION

Although the AODE / 4R70W is a 4-speed transmission, its selector lever has only three forward positions: OD, 2 and 1. On a B&M automatic shifter, these positions are DRIVE (or 3), 2 and 1.

**For normal street driving (with the shifter in DRIVE or 3),** the transmission is in OD, and will automatically shift between all four forward gears (including 4th / Overdrive), depending on vehicle speed.

**With the shifter in 2,** the transmission will automatically shift between its first three forward gears (1st through 3rd / Direct Drive), depending on vehicle speed.

**With the shifter in 1,** it will automatically shift between 1st (Low) and 2nd Gears, depending on vehicle speed.

**Shifting from DRIVE (or 3) to 2** will always shift the transmission from 4th / OD to 3rd Gear. And **shifting to 1** will shift the transmission to either 2nd or 1st (Low) Gear.

---

## KEEP THESE INSTRUCTIONS FOR FUTURE REFERENCE

B&M Performance & Off-Road maintains a highly-trained technical service department to answer your technical questions, provide additional product information and offer various recommendations.

**B&M TECHNICAL SUPPORT: (866) 464-6553**

