

20 ga WHITE

DESCRIPTION	COLOR	WIRE GAUGE	PIN *
COIL - IN	YELLOW	PLUG	A1
FUEL PUMP RELAY OUT (10A MAX)	RED	20 ga IF RELAY TRIGGER	A2
INPUT #2 (F52THG)	WHITE/RED	PLUG	A3
INPUT #4 (F,G,5)	WHITE/ GREEN	PLUG	A4
TPS SIGNAL	GREEN	20 ga	A5
POINTS OUTPUT	WHITE	PLUG	A6
WBI_COMPR2	TAN	22 ga	A7
WBI SHIELD	SHIELD	22 ga	A8
WBI HTR-	YELLOW	18 ga	A9
SWITCHED +12V IN	RED/WHITE	18 ga	A10
MAT INPUT	BLUE	20 ga	A11
INPUT #1 (F52THG)	WHITE/BLUE	PLUG	A12
INPUT #3 (F G 5)	WHITE/BLACK	PLUG	A13
IPU GROUND	SHIELD	22 ga	A14
DG1 TX	WHITE/BLACK	PLUG	A15
WBI COMPRI	BROWN	22 ga	A16
WBI VS-/IP-	BLACK	22 ga	A17
SENSOR GROUND OUT	BLACK/WHITE	20 ga	A18
COOLANT TEMP IN	BROWN	20 ga	A19
OIL PRESSURE	GREY	20 ga	A20
KNOCK #2 IN	BEIGE/RED	PLUG	A21
CAM INPUT (DIG & IPU)	PURPLE	22 ga	A22
MAP SENSOR SIGNAL	RED/BLACK	20 ga	A23
CAN LO	ORANGE	20 ga	A24
WBI VS+	RED	22 ga	A25
SENSOR +5V REF OUT	ORANGE	20 ga	A26
BYPASS OUT	BEIGE/BLACK	PLUG	A27
TACHOMETER	BLUE/WHITE	22 ga	A28
KNOCK #1 INPUT	BEIGE/BLUE	PLUG	A29
CRANK INPUT (DIG & IPU)	PURPLE	22 ga	A30
FUEL PRESSURE	PURPLE	20 ga	A31
CAN HI	ORANGE/BLACK	20 ga	A32
WBI IP+	WHITE	22 ga	A33
WBI HTR+	ORANGE	18 ga	A34

DESCRIPTION	COLOR	WIRE GAUGE	PIN *
IAC A LO	PURPLE/BLUE	20 ga	B1
IAC A HI	PURPLE/YELLOW	20 ga	B2
PWM #4 OUT (HG)	GREY/GREEN	20 ga	B3
INJECTOR F	GREEN	PLUG	B4
INJECTOR G	ORANGE	PLUG	B5
INJECTOR H	BLUE	PLUG	B6
INJECTOR E	PINK	PLUG	B7
IAC B LO	PURPLE/WHITE	20 ga	B8
IAC B HI	PURPLE/BLACK	20 ga	B9
PWM #3 OUT (HG)	GREY/BLACK	20 ga	B10
PWM #2 OUT (HG)	GREY/RED	PLUG	B11
PWM #1 OUT (HG)	GREY/YELLOW	20 ga	B12
INJECTOR D	PURPLE	20 ga	B13
EST GROUND OUT	BLACK/YELLOW	20 ga	B14
EST B	GREEN/WHITE	20 ga	B15
EST D	ORANGE/WHITE	20 ga	B16
EST F	BLUE/WHITE	20 ga	B17
EST H	PINK/WHITE	20 ga	B18
INJECTOR A	GREY	20 ga	B19
EST 12V OUT	RED/YELLOW	20 ga	B20
EST A	YELLOW/WHITE	20 ga	B21
EST C	GREY/WHITE	20 ga	B22
EST E	LIGHT BLUE/WHITE	20 ga	B23
EST G	LIGHT GREEN/WHITE	20 ga	B24
INJECTOR C	BEIGE	20 ga	B25
INJECTOR B	WHITE	20 ga	B26

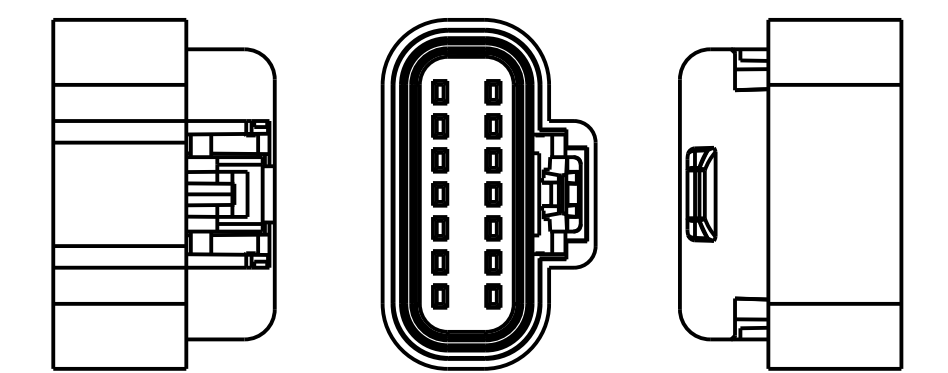
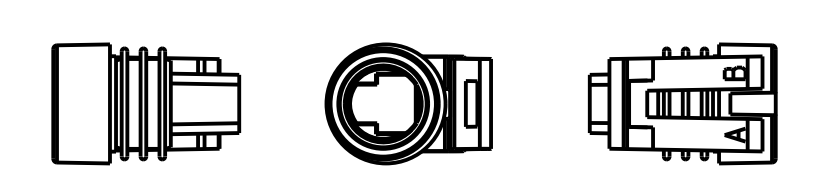
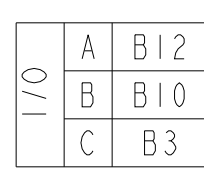
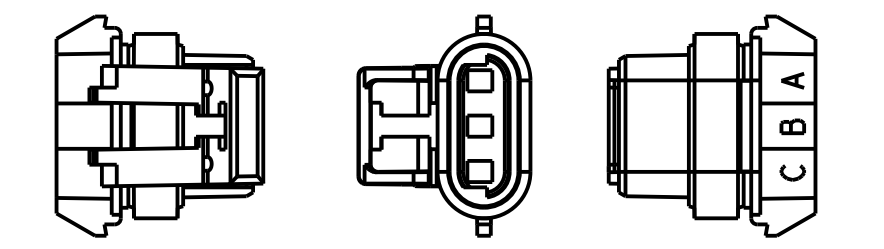
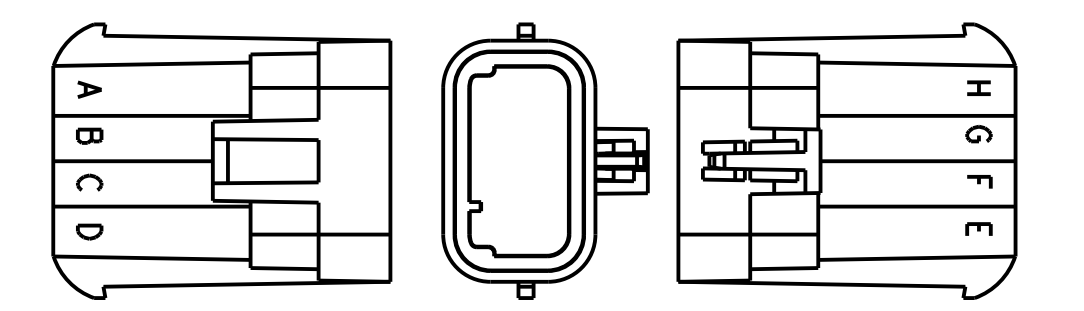
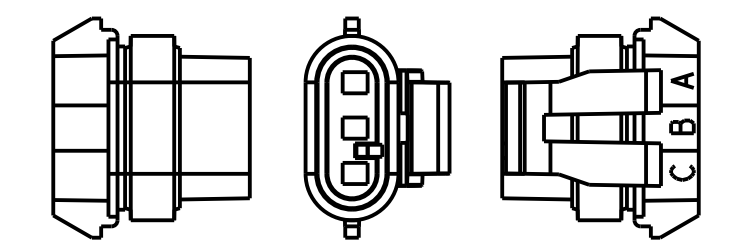
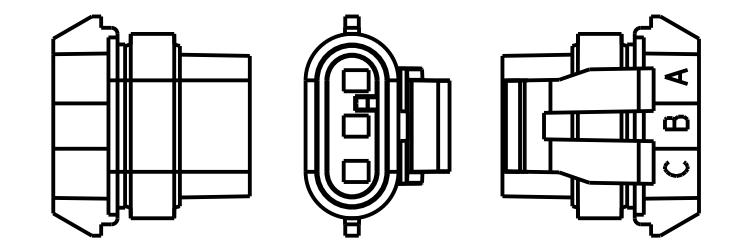
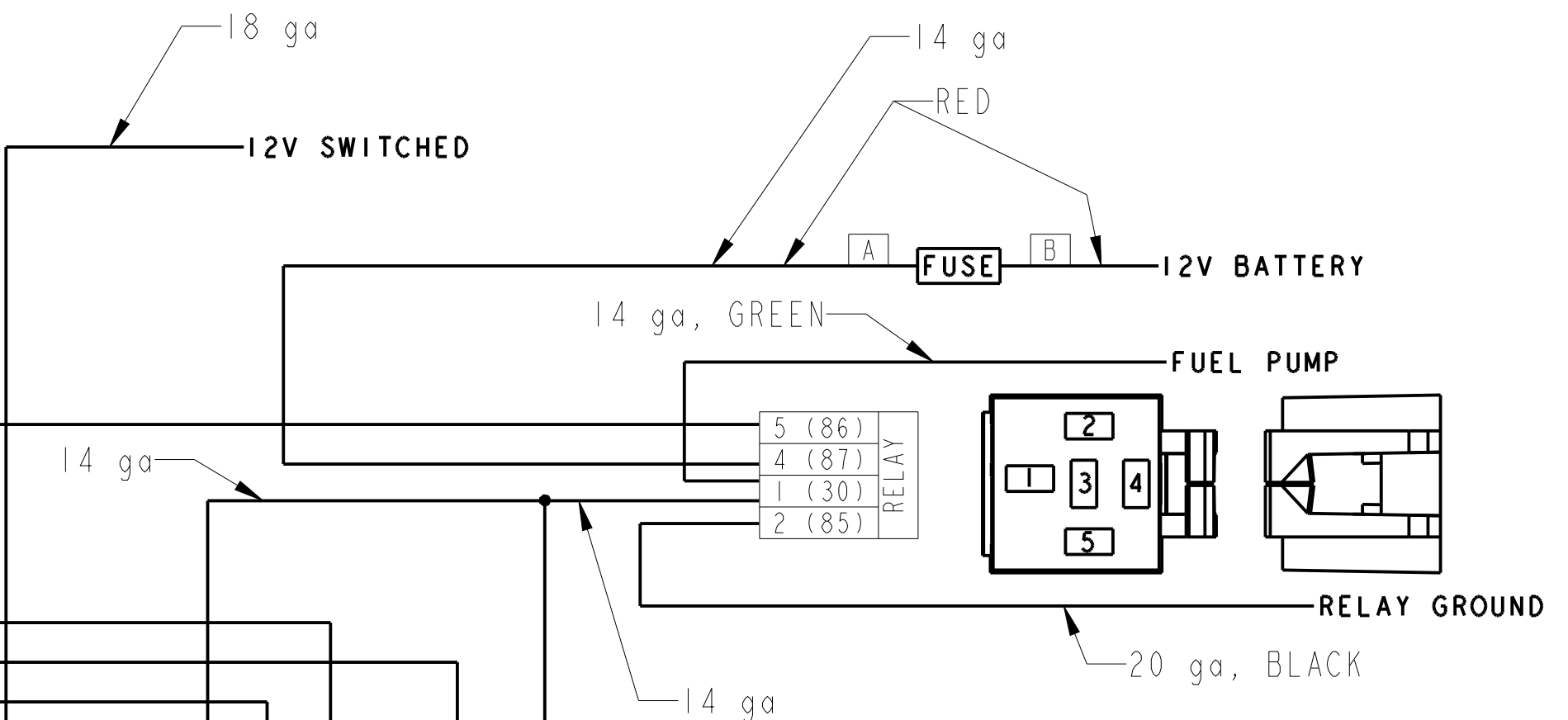
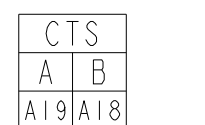
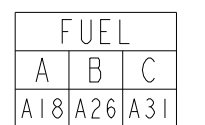
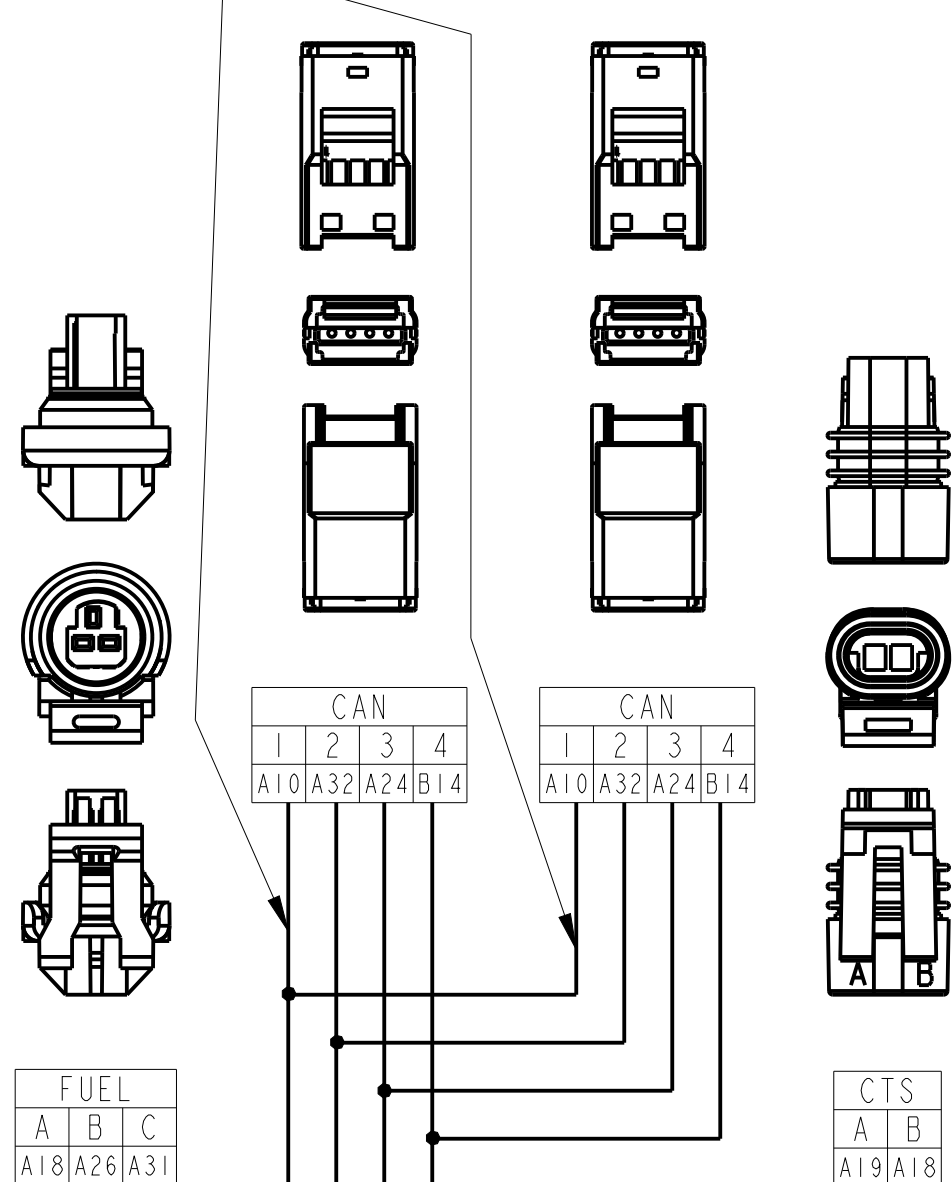
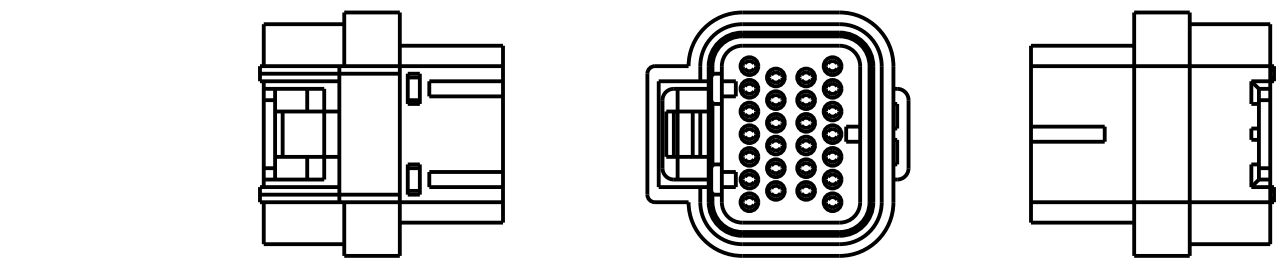
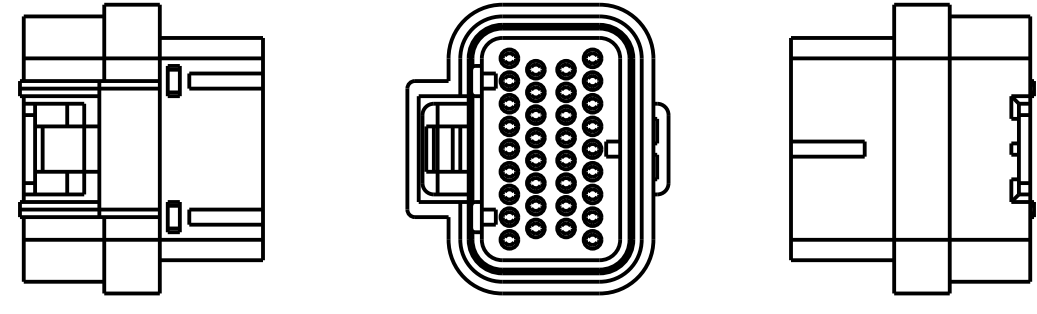

DESCRIPTION	PIN #	WIRE GAUGE	COLOR
CHASSIS GROUND	A	16 ga	BLACK
B15	B	---	---
B16	C	---	---
B17	D	---	---
B18	E	---	---
B19	F	---	---
B20	G	---	---
30	H	16 ga	---

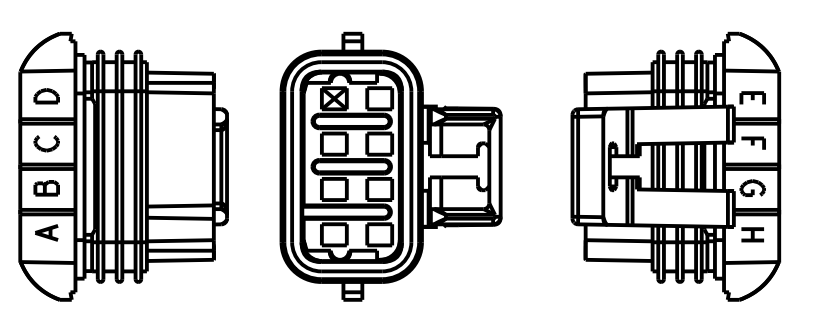

DESCRIPTION	PIN #	WIRE GAUGE	COLOR
CHASSIS GROUND	A	16 ga	BLACK
B24	B	---	---
B23	C	---	---
B14	D	---	---
B22	E	---	---
B21	F	---	---
B20	G	---	---
30	H	16 ga	---

