

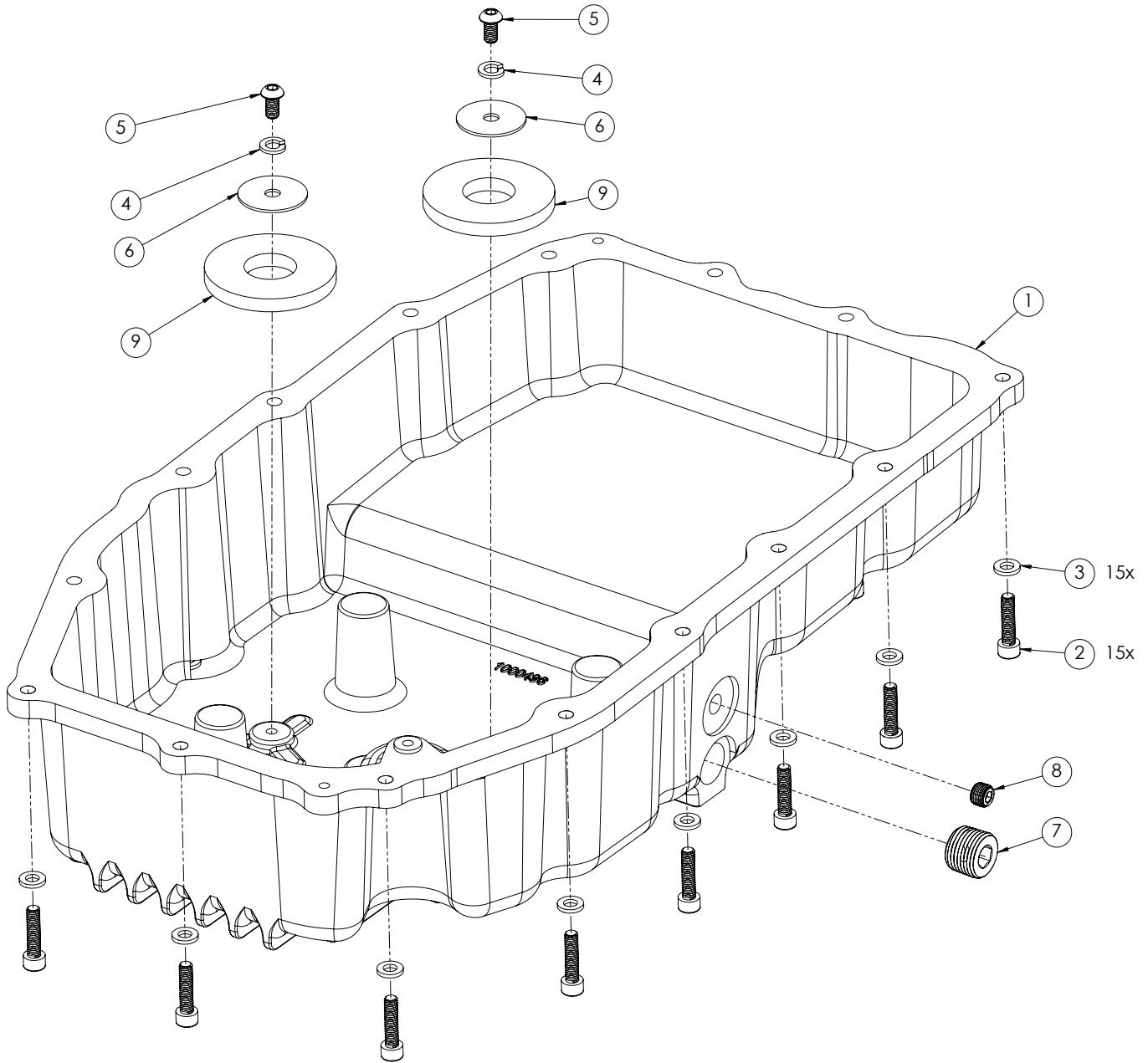

Installation Instructions
70399 & 71399
 GM 2019-2024
TRUCKS WITH ACCUMULATOR
 8L90E Transmissions



ITM #	PART #	DESCRIPTION	QTY.
1	1000497	Deep Pan	1
N/A	70396BA	Hardware Package includes:	1
2	3401486	M6-1.0 x 25mm Screw	15
3	3401487	M6 Flat Washer	15
4	3401195	M6 Lock Washer	2

ITM #	PART #	DESCRIPTION	QTY.
5	3401723	M6-1.0 x 12mm Screw	2
6	3401488	¼" Flat Washer	2
7	3401492	½" Magnetic Socket Plug	1
8	3401485	⅛" NPT Plug	1
9	3401722	Ring Magnet	2

OVERVIEW:

Thank you for purchasing B&M 70399 Transmission Pan. This kit is designed to work on 8L90E with accumulator. Be sure to acquire the factory fill procedure, which varies between specific models, prior to beginning project.

B&M also offers the following related products:

Transmission Dipstick (22173): Add a remote dipstick to accurately measure your transmission fluid level.

Temperature Gauge (80212): Add a gauge to monitor your transmission fluid temperature.

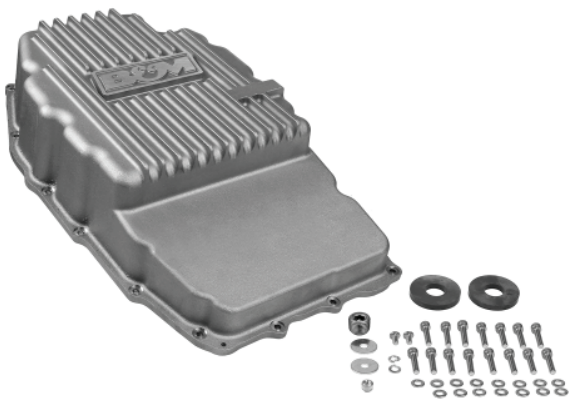

1. Please take a moment to read and understand these instructions before installing your purchased performance kit. Use the parts drawing and list to verify kit contents.

REMOVE FACTORY TRANSMISSION PAN:

WARNINGS:

- Automatic transmissions operate at temperatures between 150° and 250°. To avoid burns from hot oil and parts, allow vehicle to cool off for a few hours before beginning installation.
- Maintain clean working surface as transmission components are precision fit so any dirt will directly impact success of installation.
- Vehicle must be level for stability and to obtain an accurate fluid level.

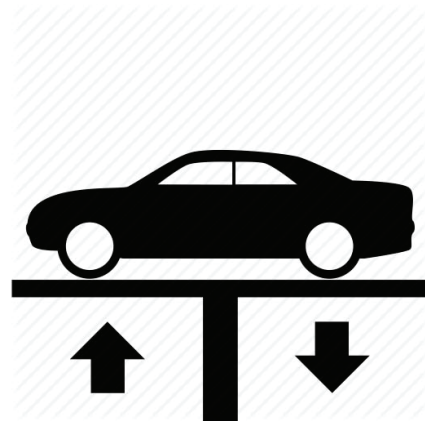

2. Raise vehicle up on a hoist or rack to working height. If you don't have access to a hoist or rack, raise vehicle and support securely with jack stands. Verify your vehicle will not move as you complete installation of your performance product.

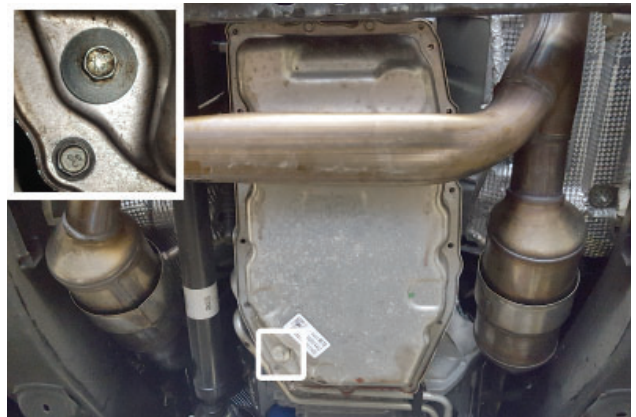

3. Place drain pan under transmission. Remove then wipe check bolt, while draining fluid from pan.

NOTE: Draining fluid through check bolt opening will only partially drain transmission pan. Be aware of remaining fluid leaking out as you finish removing pan.



4. Remove wire loom, remove bolts (x3) and side cover from passenger side of transmission. Retain for later re-use.

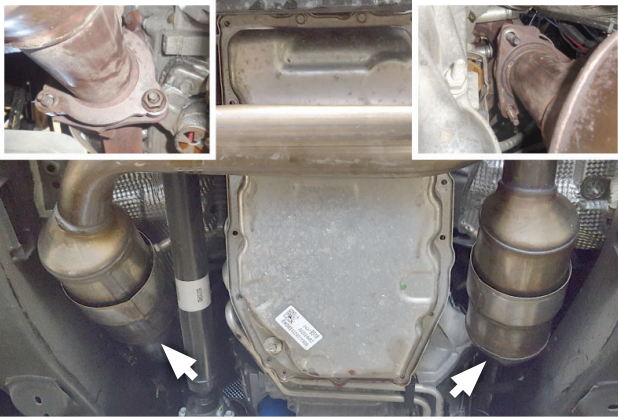

- Remove (x3 ea.) nuts securing passenger and driver side exhaust manifolds to exhaust pipe. Then pull headers from their mounts.



NOTE: Remove bolts starting from front of pan then moving laterally towards back to direct remaining fluid into drain pan.

- Remove bolts (x16) securing transmission pan to case, then carefully remove pan from vehicle.

ASSEMBLE AND INSTALL FLOWMASTER PERFORMANCE TRANSMISSION PAN:

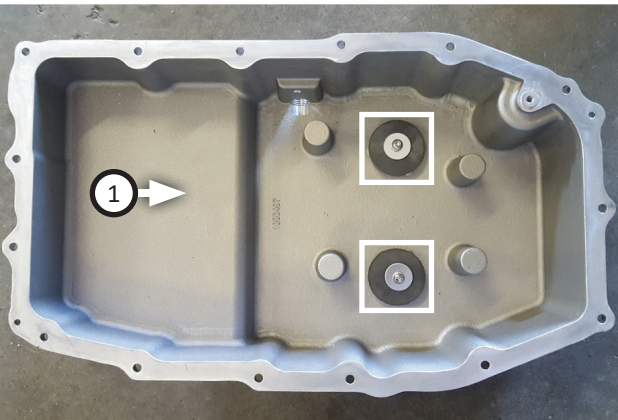

- Install (x2) screws (5) through (x2 ea.) lock washers (4), flat washers (6), and magnetic rings (9) then into deep pan (1).

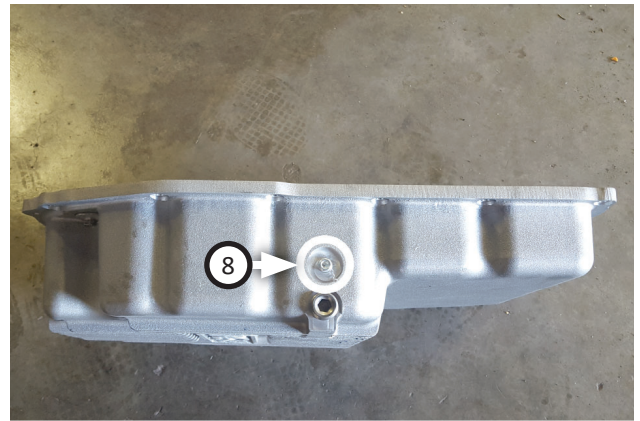

- This kit includes a 1/2 NPT port above drain plug that can be used for an optional transmission temperature gauge. (available separately) Otherwise, install NPT plug (8).

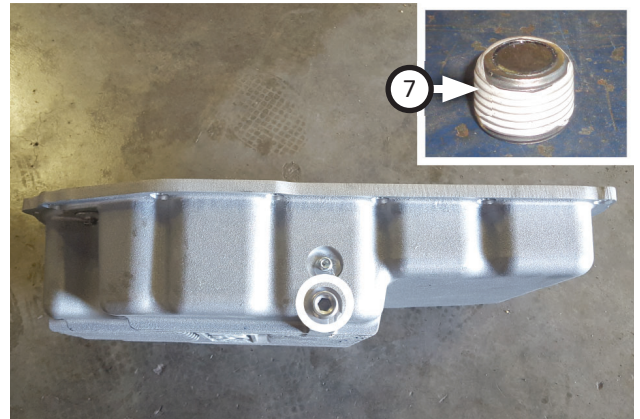

- Apply Teflon tape to socket plug (7) before installing it into deep pan.

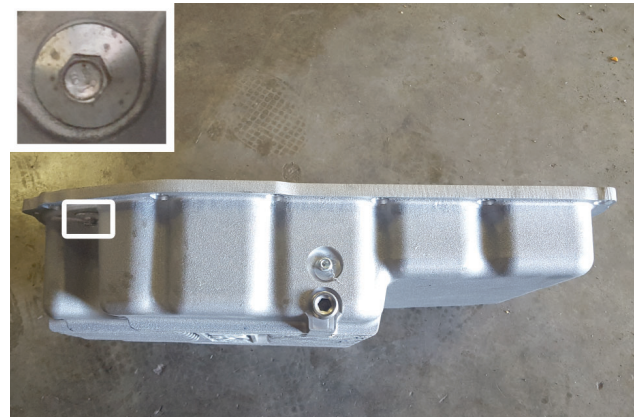

- Make sure check bolt (removed step 3) still has seal, then install it into deep pan.

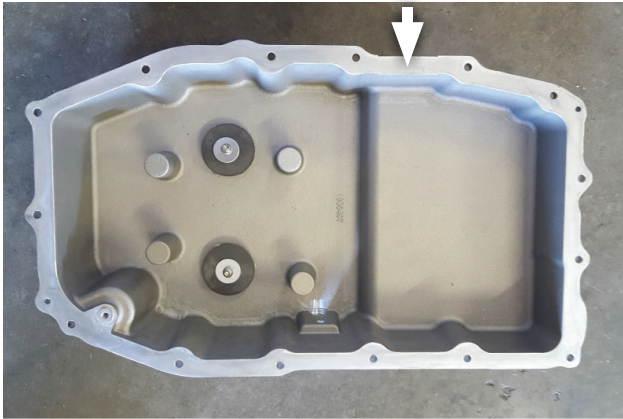

11. Inspect gasket (removed step 9) for flattened ridges or compressed edges then install it onto deep pan where indicated.



12. Use lint free rag to clean transmission pan mounting surface, then install deep pan with (x15 ea.) screws (2) and flat washers (3). Torque screws to 8 ft/lbs.



13. Fill your transmission fluid according to vehicle manufacturers procedure.
14. If you have chosen to purchase a dipstick; install it now.



15. Allow exhaust to cool then re-install. Also install side cover and wire loom (removed step 4).



Congratulations, the installation of your B&M Racing performance Transmission Pan is now complete!

MONITORING TRANSMISSION:

To accurately monitor your transmission fluid level, it is important to always follow the same procedure when checking it:

- Check transmission fluid level at operating temperature. If necessary, drive vehicle for 10-15 minutes to bring transmission up to temperature.
- Park on level ground. With vehicle running at idle, slowly move gear shift level from PARK down through entire gear range, then back to PARK again, stopping for a few seconds at each gear position. With transmission in PARK, leave vehicle running at idle.
- Remove dipstick, wipe it off and reinstall it (with knob fully hand tight). Then remove dipstick again to check fluid level.

