

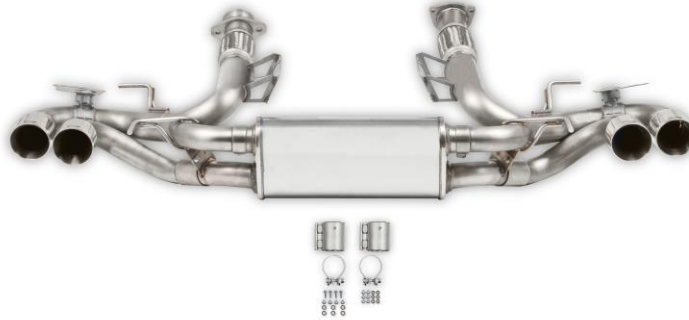

**2020 C8 Corvette 6.2L V-8
3" to 2-1/2" Hooker Blackheart 304SS, Cat-Back Exhaust System
With NPP Dual Mode & AFM Valve simulators
BH13236**

Installation Instructions



NOTE: Reuse OE factory electronic exhaust valve actuators.

Thank you for making HOOKER HEADERS your choice in a high-performance exhaust system. Extensive dyno/track testing has enabled HOOKER to offer the most advanced design in exhaust systems. The installation, while not complex, will take a certain amount of time. However, the additional horsepower and improved performance will more than justify your efforts. Proper installation and maintenance will ensure long life and maximum performance from your HOOKER HEADER exhaust system.

BEFORE STARTING:

Your vehicle must be raised a minimum of 36 inches. A floor hoist is ideal. If no hoist is available, we strongly urge the use of axle stands as a safety measure. Please read these instructions in their entirety before attempting installation.

CAUTION! WORK ONLY ON A LEVEL SURFACE. USE JACKS /JACK STANDS OF SUFFICIENT CAPACITY TO LIFT AND SUPPORT YOUR VEHICLE. NEVER WORK UNDER A VEHICLE SUPPORTED BY A FLOOR OR BUMPER JACK.

INCLUDED HARDWARE:

Qty.	P/N	Description
2	556R22	Band Clamp, 2.5" x 1.25" Wide, 430 SS
2	556R26	Exhaust Coupler, 2.5", 409SS Torca
6	539R28	6MM, Serrated-Flange Locknuts
4	505R73	1/4-20 x .75, Flanged Hex Head Bolt
4	539R21	1/4-20, Serrated-Flange Locknuts
6	546R26	6MM Flat Stainless Steel washer
6	40R1077	Aluminum Spacer
2	559R94	Decal - Blackheart 4" x 2"

Check the hardware package. If anything is missing, please contact Technical Service at 1-866-464-6553 or 270-781-9741.

REMOVING THE OE EXHAUST:

1. Disconnect the negative cable from the vehicle battery.
2. Lift the vehicle and secure on jack stand.
3. Start at the rear of the vehicle and remove the right and left wheels and inner fenders.
4. Now, go under the car and remove the (x2) rear plastic covers (**Figure 1**).



Figure 1

5. Remove the rear bumper fascia and unplug all the wiring that connects to the rear bumper fascia (**Figures 2 & 3**).



Figure 2

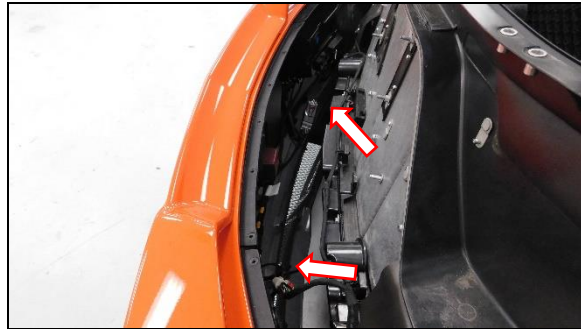

Figure 3

6. Unplug (x4) connectors on the exhaust valve electronic actuators. Remove (x5) nuts on the right and left exhaust flanges that connect to the OE catalytic converters. Remove the (x4) exhaust hangers out of the rubber isolators and remove the OE cat back from the car.

INSTALLATION:

1. Preassemble the Blackheart exhaust using the supplied hardware. Remove the (x4) OE exhaust electric actuators and (x4) rubber OE isolators off the OE exhaust. Install these on to the Blackheart exhaust system. (**Figures 4, 5, 6, 7, & 8**).

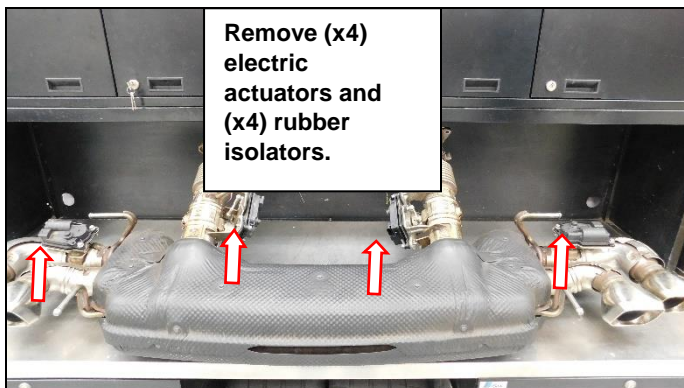

Figure 4

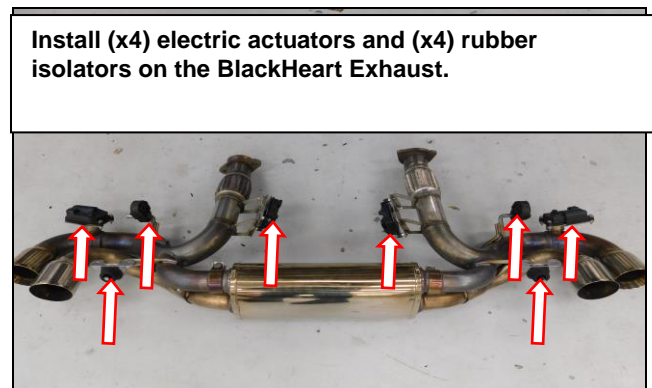

Figure 5

NOTE: On the AFM (Active Fuel Management) Exhaust Valve Simulators, install the (x6) aluminum spacers and reuse the OE bolts. After installing, make sure the electronic actuators arms are pointing in the up position.

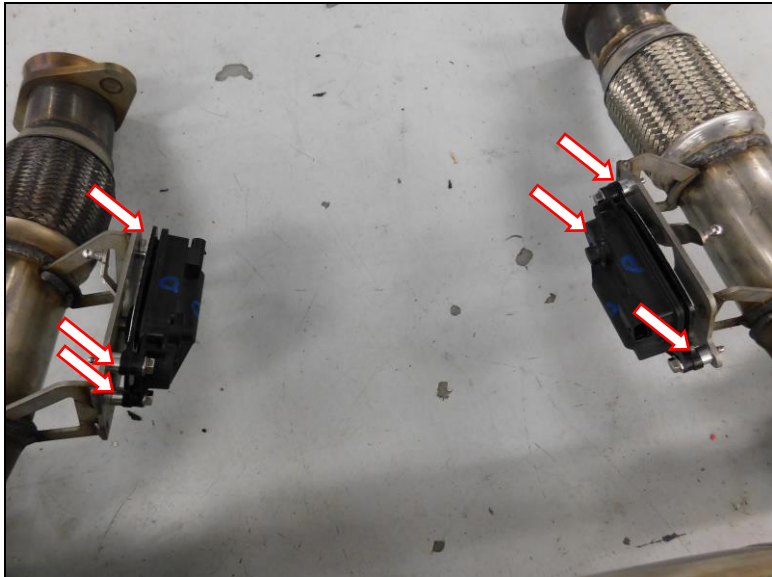

Figure 6

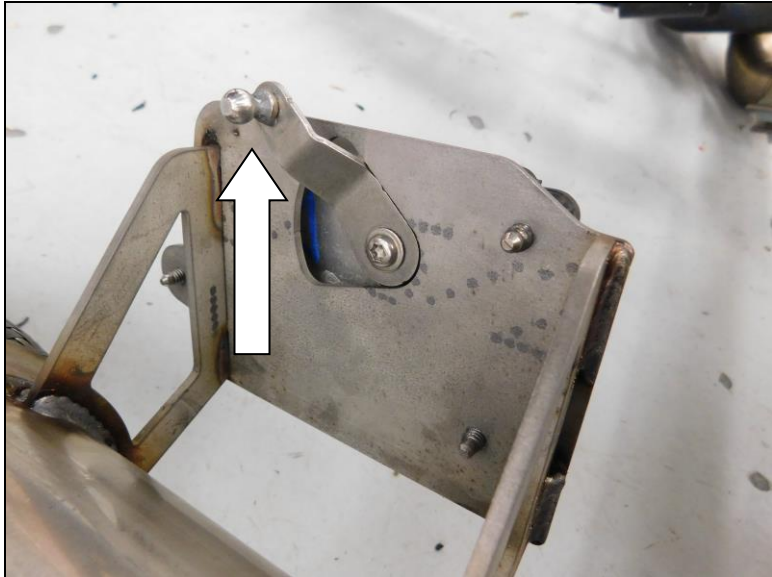
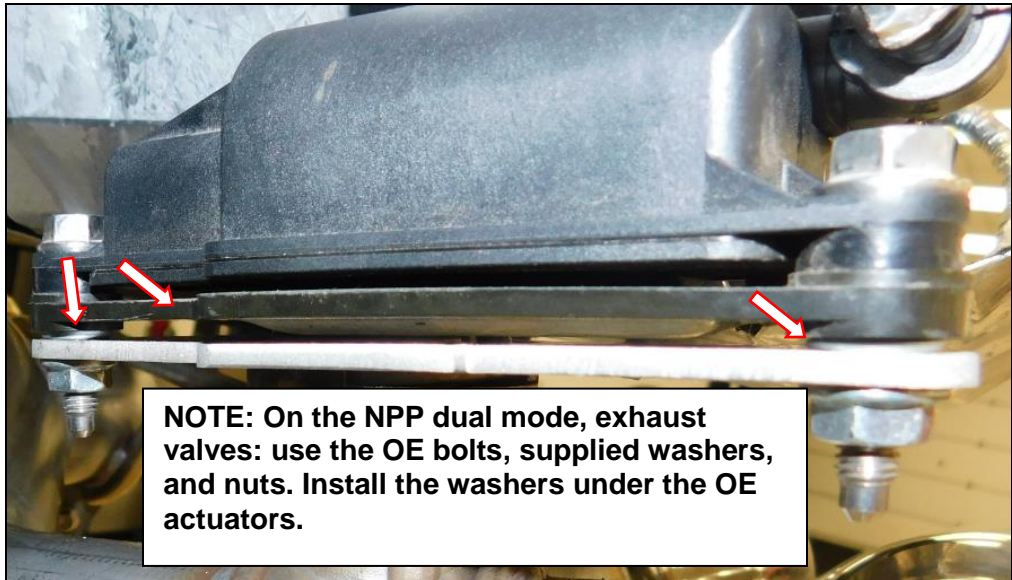

Figure 7



NOTE: On the NPP dual mode, exhaust valves: use the OE bolts, supplied washers, and nuts. Install the washers under the OE actuators.

Figure 8

2. Reuse the OE gaskets and hardware replace if needed. Install the Blackheart cat-back exhaust to the OE catalytic converters. Install the OE rubber isolators to the car. Plug in (x4) connectors to the OE electric exhaust valve actuators. Tighten the hardware (**Figure 9**).



Figure 9

3. Reconnect the wiring to the rear bumper fascia. Reinstall the rear bumper fascia. Reinstall the (x2) under the car plastic covers, (x2) inner fenders, and the right and lefts wheels. Line up the exhaust tips and tighten all hardware (**Figure 10**).



Figure 10

4. Re-check your work.
5. Remove the jack stands and lower the vehicle.
6. After 150 miles, re-check and tighten all bolts and clamps.

NOTE: It is normal for the Blackheart Exhaust System to emit smoke for the first few minutes during break-in period.

LIMITATION OF LIABILITY – DISCLAIMER:

The regulation of emissions production, noise levels, and safety standards is undertaken by the federal government, each of the fifty state legislatures, and by many local municipalities, towns, and counties.

HOOKER™ makes no warranties of merchantability, of fitness for particular purpose, or that its products are approved for general use, or that its products comply with laws, regulations, or ordinances in the state where they may be sold to the ultimate purchaser, the consumer.

Unless expressly stated to the contrary in the catalog, instruction sheet; or price list, the entire risk as to the conformity of any company product in any such state and as to repair should the product prove to be defective or non-conforming, is on the retail purchaser, the buyer, the ultimate consumer, of such product and it is not upon the seller, distributor, or manufacturer.

In this connection, the retail purchaser, the buyer, the ultimate consumer assumes the burden of the entire cost of any and all necessary service, alterations, or repair.

THE FOREGOING STATEMENT LIMITS THE LIABILITY OF THE MANUFACTURER.

California vehicle code, sections 27156 and 38391, prohibits the advertising, offering for sale, or installation of any device, which modifies a vehicle's emission control system, unless exempted, unless otherwise noted. HOOKER™ Headers that have not received an Executive Order (E.O.) exemption from these code sections are not legal for sale or use in California on vehicles originally equipped with catalytic converters, except for racing vehicles, which may never be driven upon a highway. Check with your local authorities to determine if these headers are legal for use in your particular area.

© 2020 Hooker Headers, Inc. All rights reserved. Tous Droits Réservés.

199R12088

Revision Date: 12-10-20