

**PRINT ALL TEMPLATES AT 100% SCALE (ACTUAL SIZE) .  
DO NOT SCALE TO FIT PAGE WHEN PRINTING!**



**“DINAN by Brembo” BRAKE KIT  
INSTALLATION NOTES**

---

- a) “Dinan by Brembo” brake conversion kits contain components which are considerably larger than the stock parts currently on the vehicle. Dinan Engineering highly recommends that these new components be fit-checked per these instructions to determine if a larger wheel/tire package is necessary to clear the brakes!
  - b) Do not work on vehicles supported by a jack only. Use secure jack stands!
- 

**FIT-CHECK AND INSTALLATION OF BRAKE SYSTEM COMPONENTS:**

- 1. Cut out caliper template from the back of these instructions. You may want to use a ruler to verify the dimensions, and rescale the template on a copy machine if adjustments are needed.
- 2. Jack up the vehicle and place jack stands securely under the car such that the wheels are hanging free. Remove a front and/or rear wheel.
- 3. Hold the template against the wheel as shown.

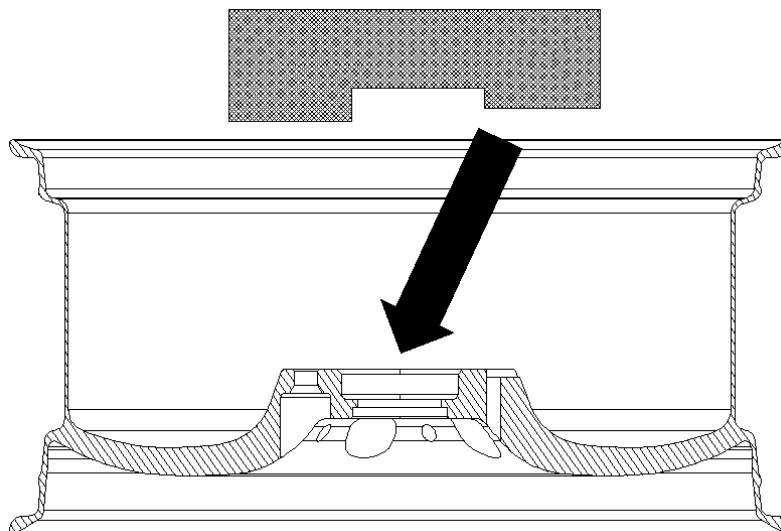

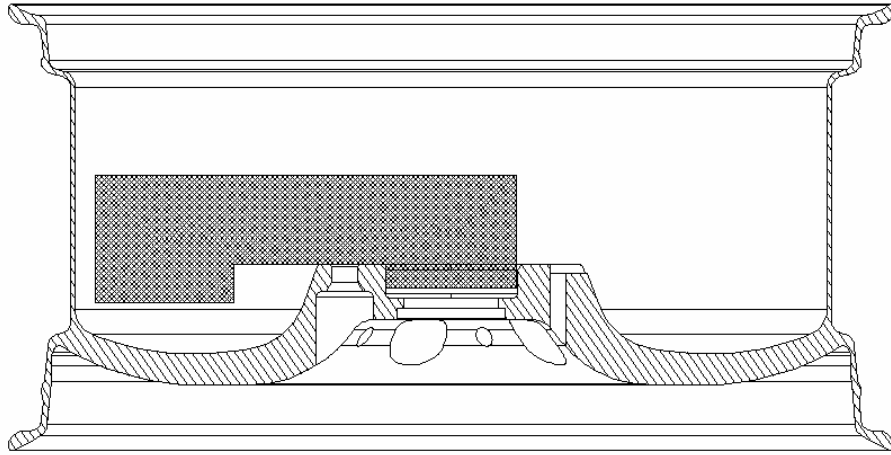

4. Confirm that the wheel can clear the caliper template as shown above. There must be at least 1/8" of clearance between the template and the wheel.
5. If clearance is not adequate, then either larger diameter and/or different offset wheels must be used! Continue with this procedure only if there is adequate clearance with the caliper template.
6. Unbolt brake caliper from strut assembly and suspend it out of the way. Do not disconnect the brake lines at this time.
7. Unbolt and remove stock brake rotor.
8. Temporarily install new brake rotor.
9. Temporarily bolt new caliper onto strut assembly.
10. Carefully bolt wheel onto hub and determine the amount of clearance that is available. Dinan recommends at least 1/8" clearance.
11. If there is enough clearance available, then you may continue with this installation per BMW & Brembo recommended procedure. If clearance is not adequate, then either larger diameter and/or different offset wheels must be used!

12. When connecting the new stainless brake lines, please add the included 14mm washer as shown. This washer will help insure that the stainless line does not get accidentally pulled thru the bracket.

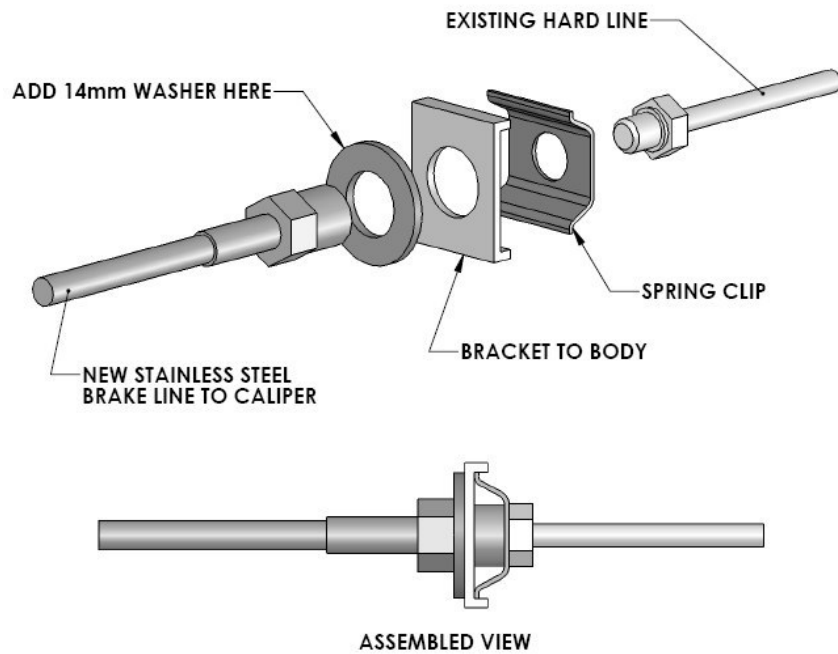

13. Some backing plates incorporate a flange that interferes with larger-than-stock brake rotors and/or brake caliper and mounting hardware. Before installation of this kit, these flanges should be trimmed using a fiberglass cutting wheel (or other suitable tool).

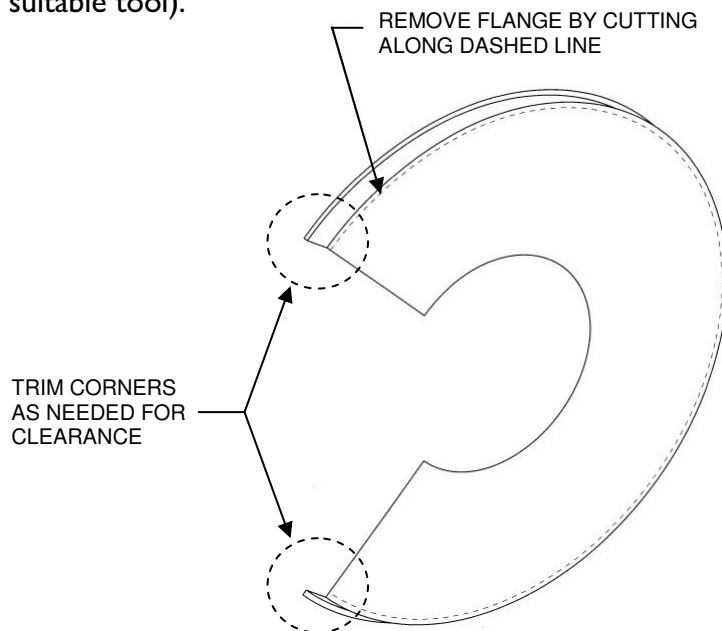

14. Torque all mounting fasteners per BMW or Brembo specifications.

## **CLEANING OF BRAKE SYSTEM COMPONENTS:**

- After installation or bleeding of the brake system, flush any brake fluid from around the bleed screws, etc., using soapy water. Over time, brake fluid trapped in these areas may cause paint damage.
- Do not use acidic wheel cleaners when washing your vehicle, as they can cause damage to the caliper finish and brake disc mounting bells, as well as to the wheels themselves. Use only soap and water when cleaning wheels or braking components.

## **BREAK-IN INSTRUCTIONS FOR NEW PADS & ROTORS:**

- New pads and new rotor surfaces need time to properly break-in before maximum braking performance can be achieved, and to prevent judder (vibration felt thru brake and steering wheel). During break-in, the pads are heat cycled, and pad material is deposited in an even layer onto the rotor face. If not broken-in properly, an uneven layer of pad material will be deposited onto the rotor, causing a vibration. Most instances of warped rotors are due to uneven pad deposition!
- The discs are delivered with a thin zinc coating to prevent corrosion. Prior to beginning the bedding procedure, this plating must be removed from the braking surfaces by driving the car slowly (under 30 mph) and performing very light brake applications in order to remove the plating without generating heat. With too much heat or pressure, this plating can be deposited unevenly on the disc, and impregnated into the pad, further increasing the likelihood of judder development.
- Once the visual inspection of the braking surfaces confirms that the plating has been evenly removed, then the bedding procedure can begin. The entire bedding procedure must be complete before driving the vehicle as normal. It is especially important that this process is completed before any extended same-speed driving is done (i.e., freeway travel). Failure to follow these instructions greatly increases the likelihood of judder development.
- After installing new pads and rotors, find a safe stretch of road and perform at least 30 brake applications of 3 second duration. Use light/medium deceleration with varying starting speeds. Leave at least 1/2 mile between each brake application.
  - Do not brake so hard that the ABS is activated! Do not brake so lightly that the pads do not come up to temperature.
  - Do NOT come to a complete stop! If you stop, then pad material will immediately be deposited onto one spot on the rotor, and you will get a vibration!

- The purpose of this procedure is to gradually increase the temperature in the components without thermal shock, and to mate the brake pad and disc friction surfaces.
- After the repeated stops, drive the vehicle for several miles with little or no braking in order to adequately cool the components.
- The system is now ready for normal use.
- **Proper break-in of your rotors and pads is critical in maximizing braking performance and help extend the service life of your new components.**

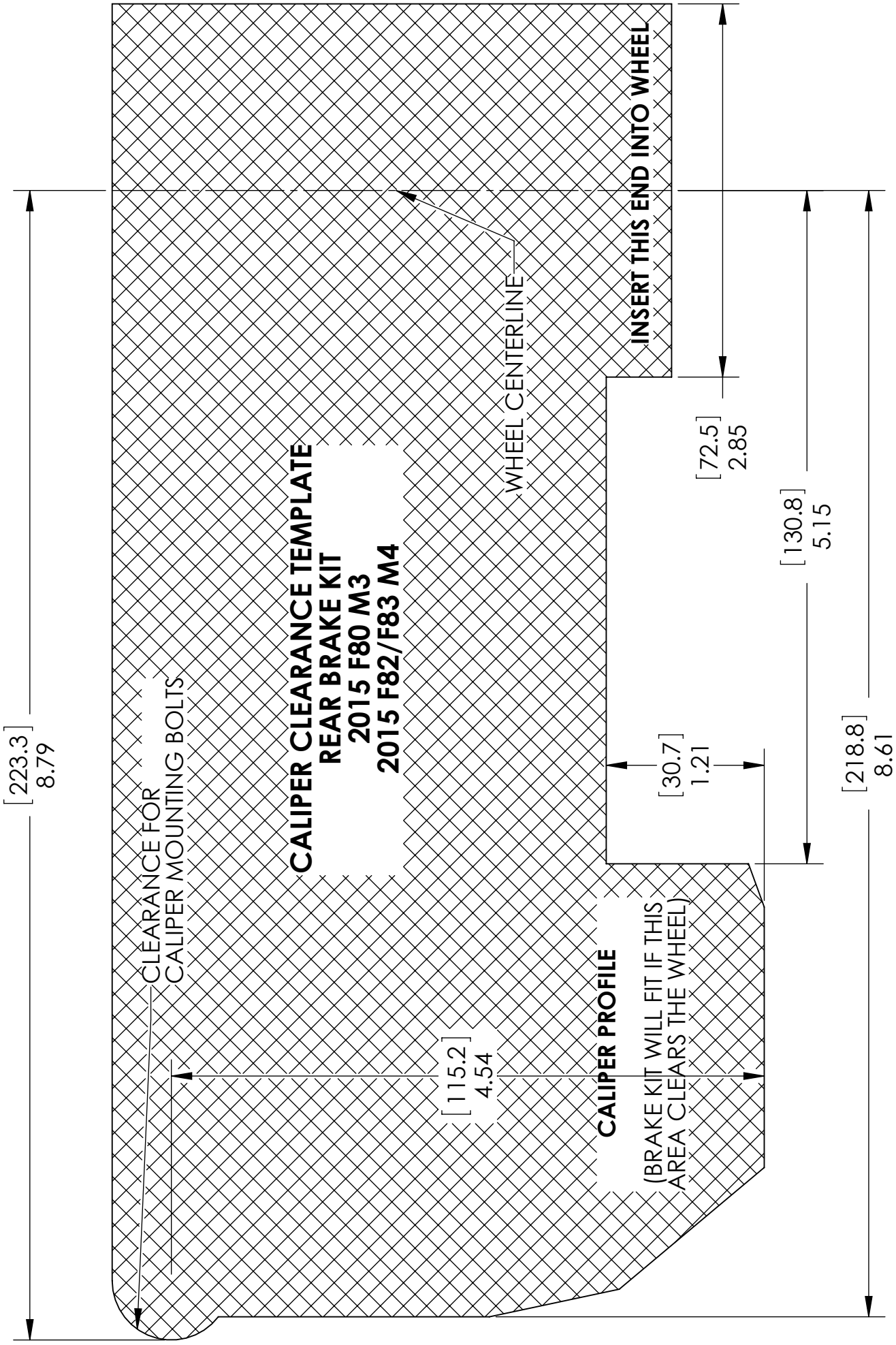

#D291-2P1.9044  
#D291-2P2.9044

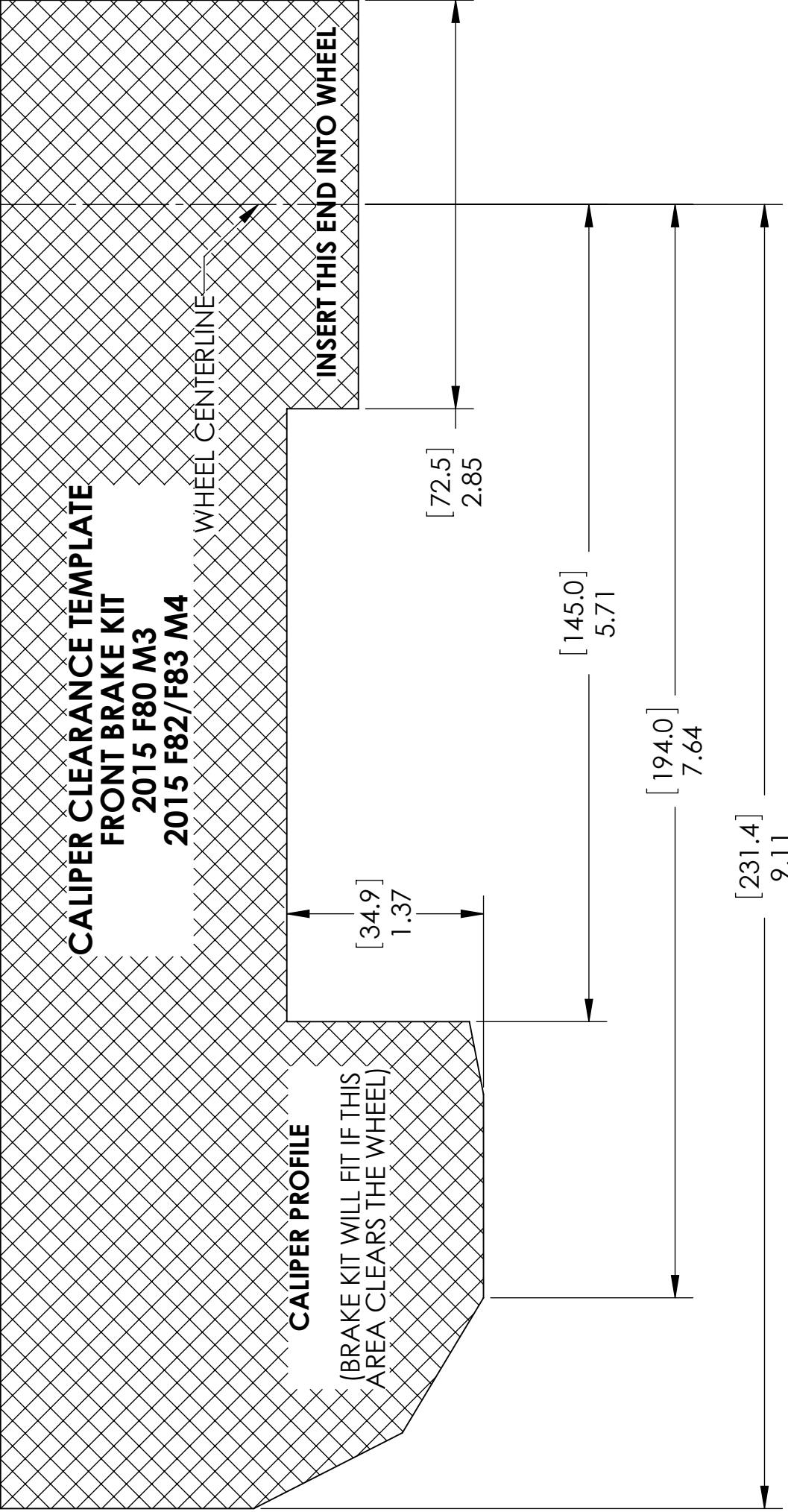

#D291-1IN1.9531  
 #D291-1IN2.9531

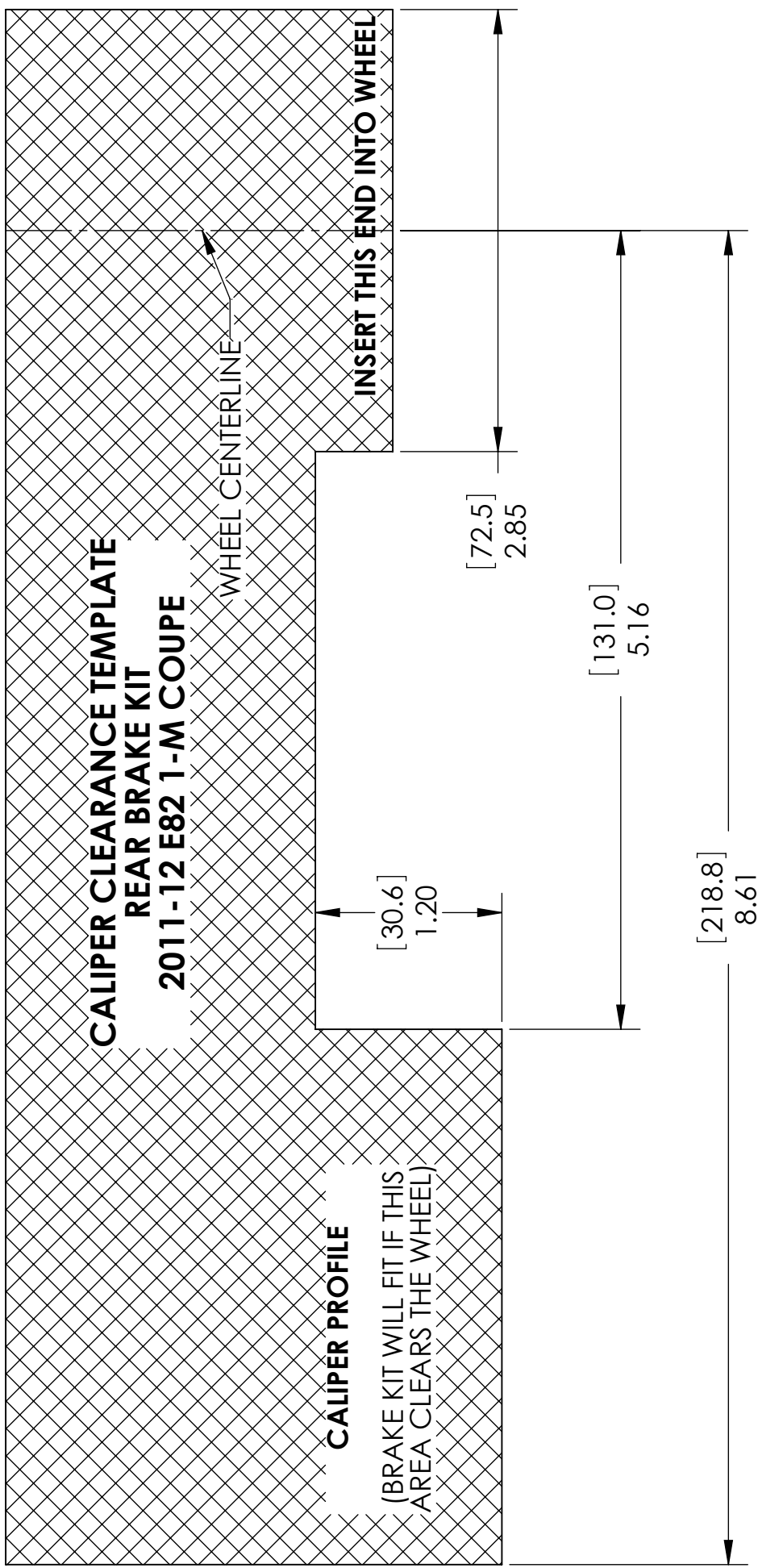

#D291-2P1.9035  
#D291-2P2.9035



[223.3]  
8.79

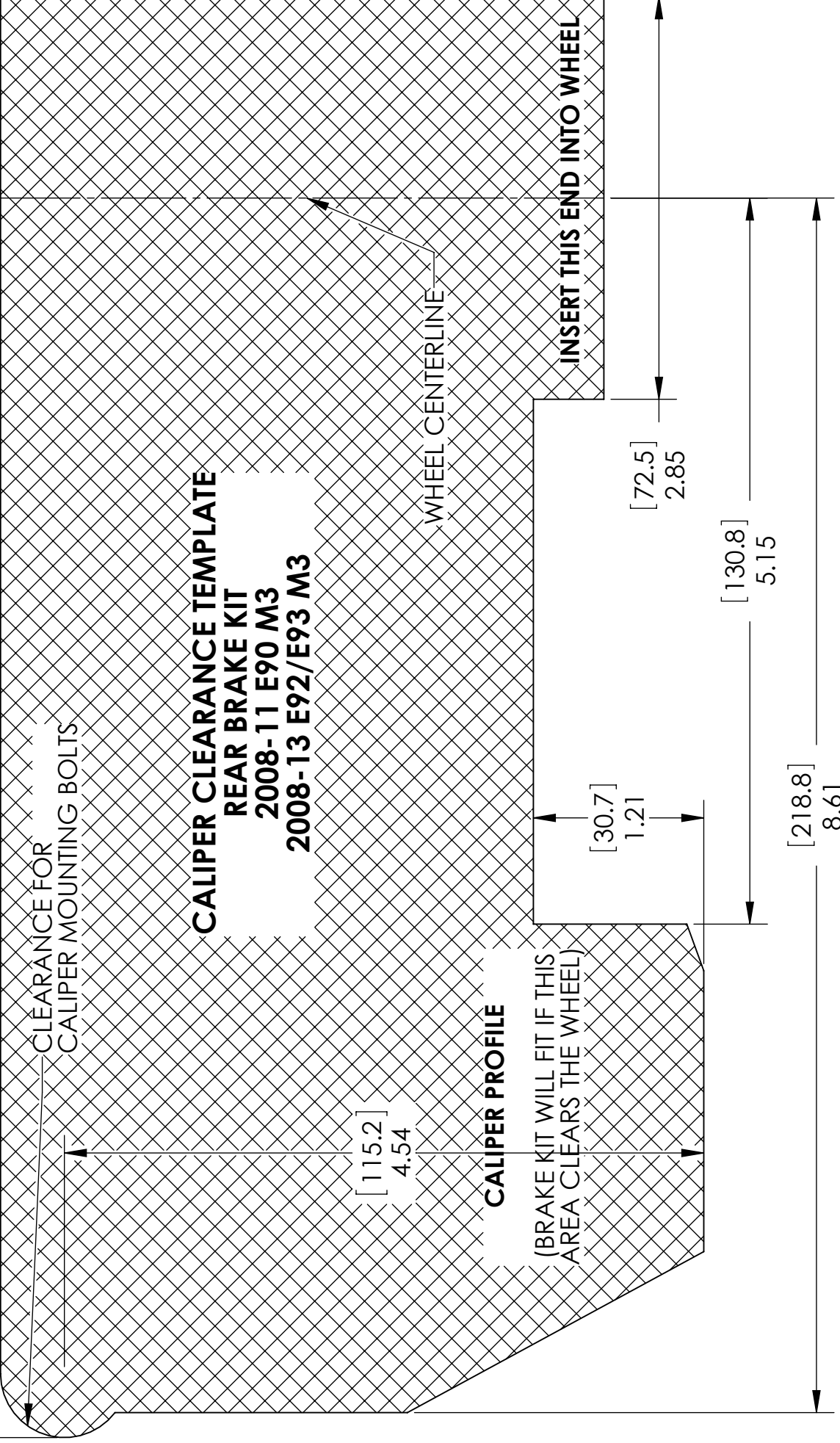

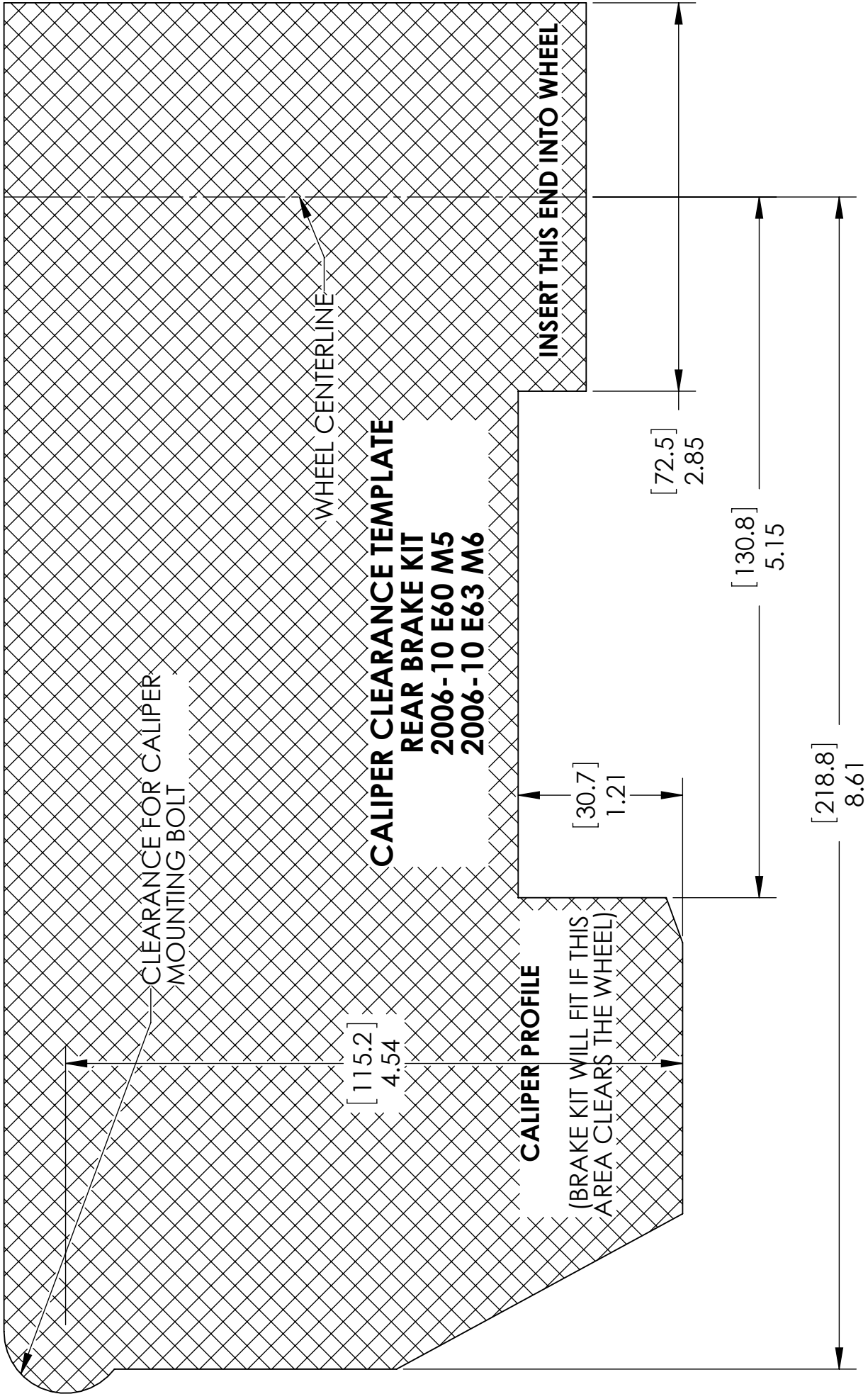

#D291-2P1.9003  
 #D291-2P2.9003

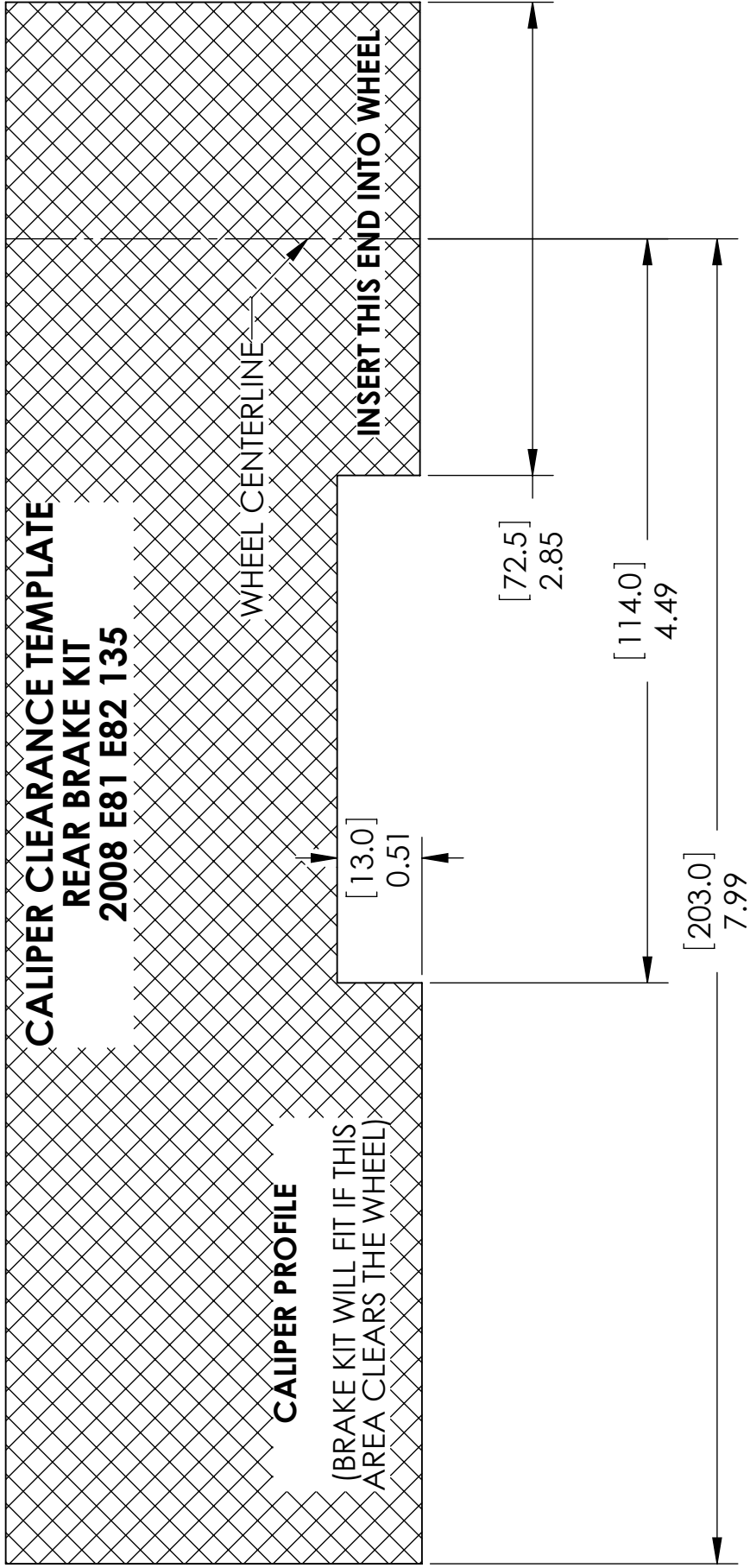

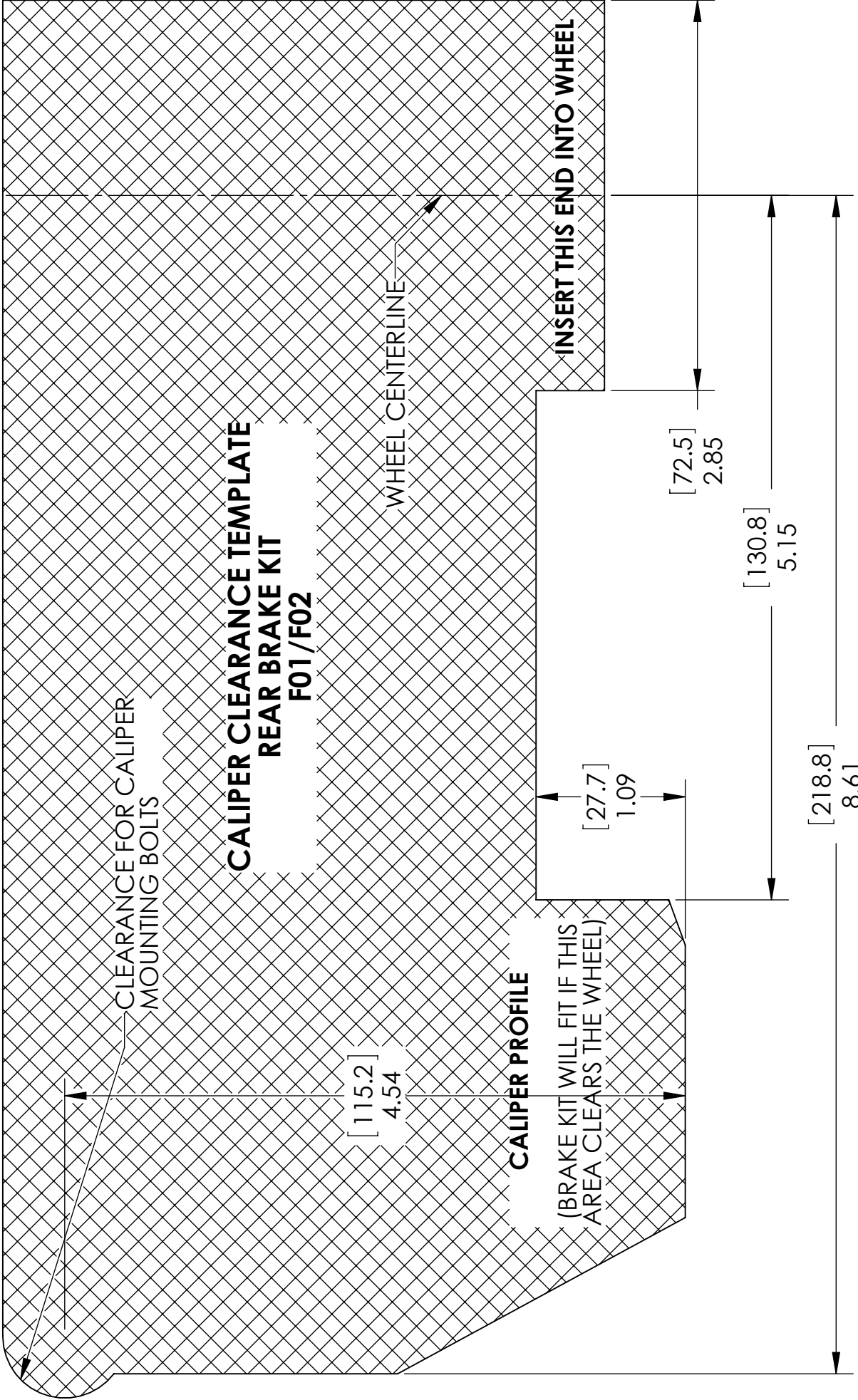

#D291-2P1.9021  
#D291-2P2.9021

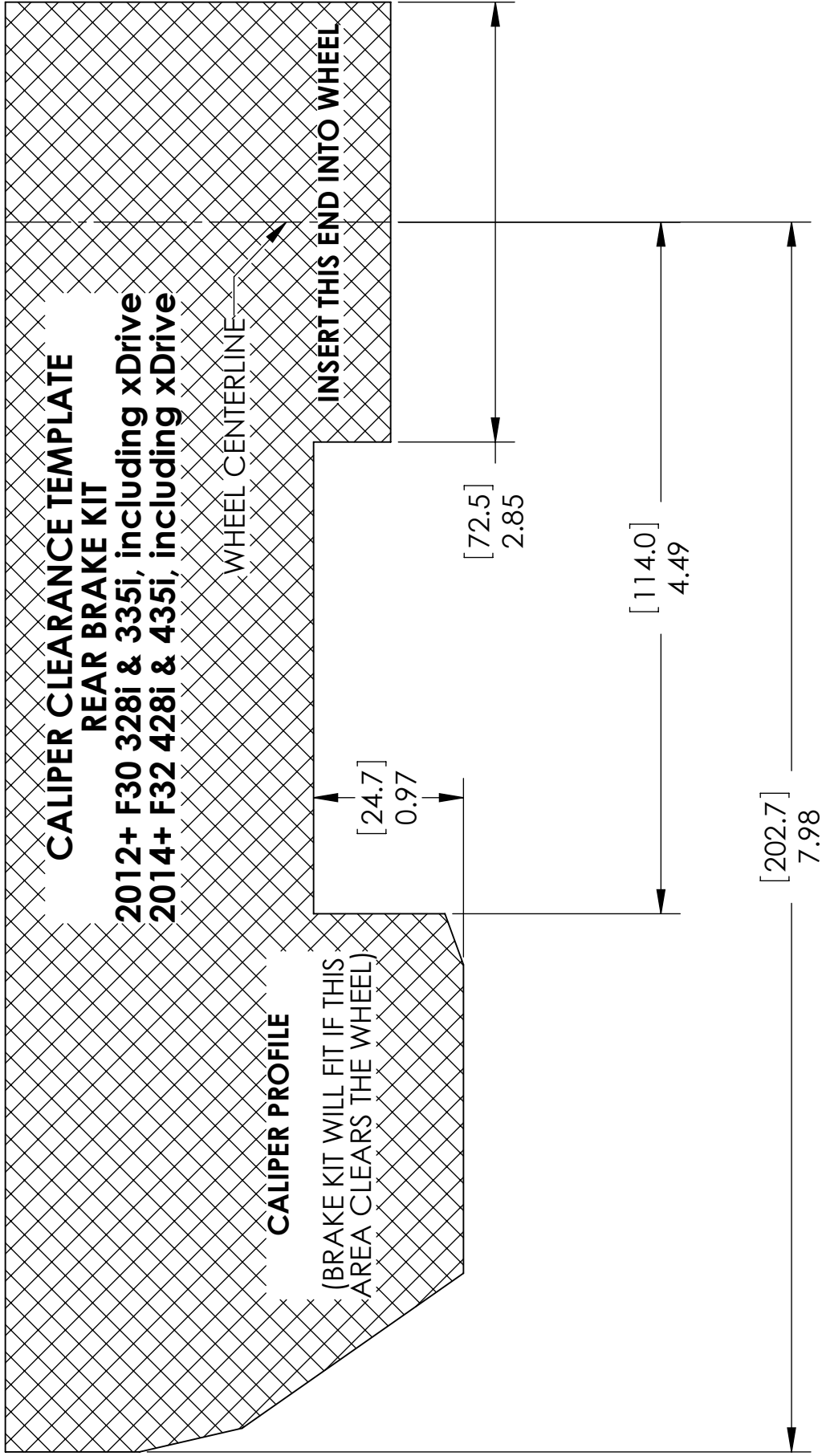

- #D291-2P1.8045
- #D291-2P2.8045
- #D291-2P1.8046
- #D291-2P2.8046
- #D291-2P1.8047
- #D291-2P2.8047
- #D291-2P1.8048
- #D291-2P2.8048

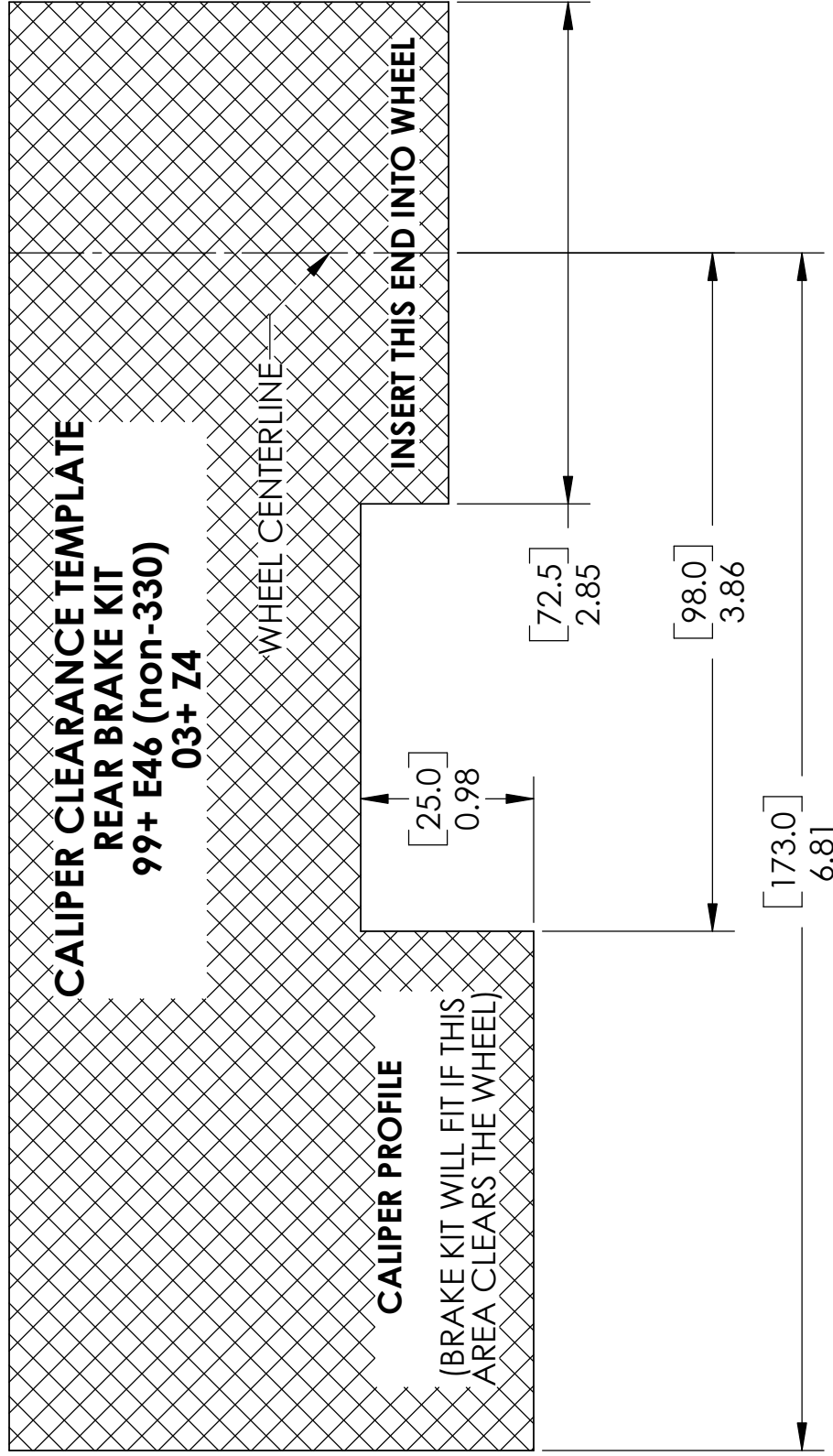

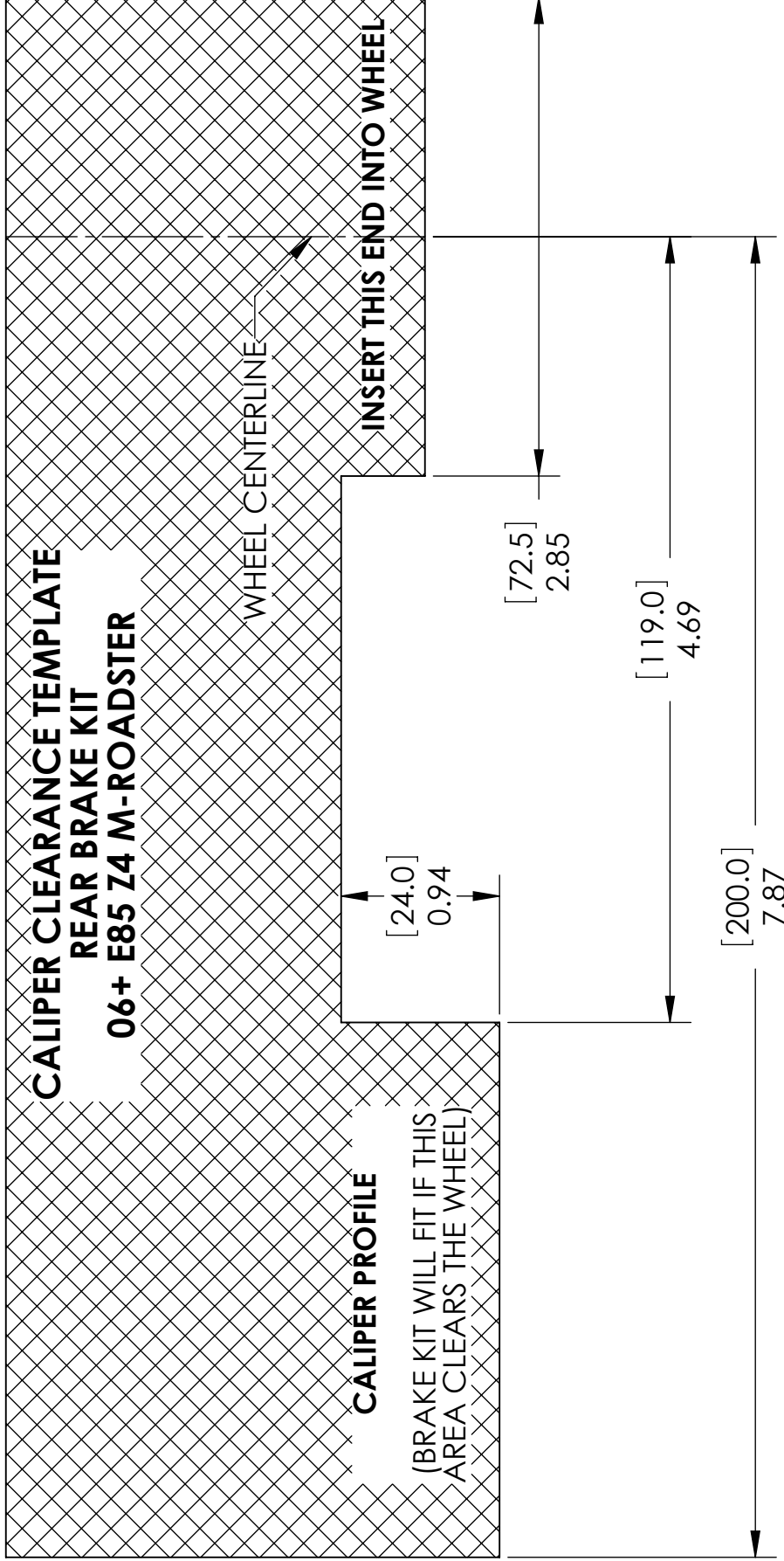

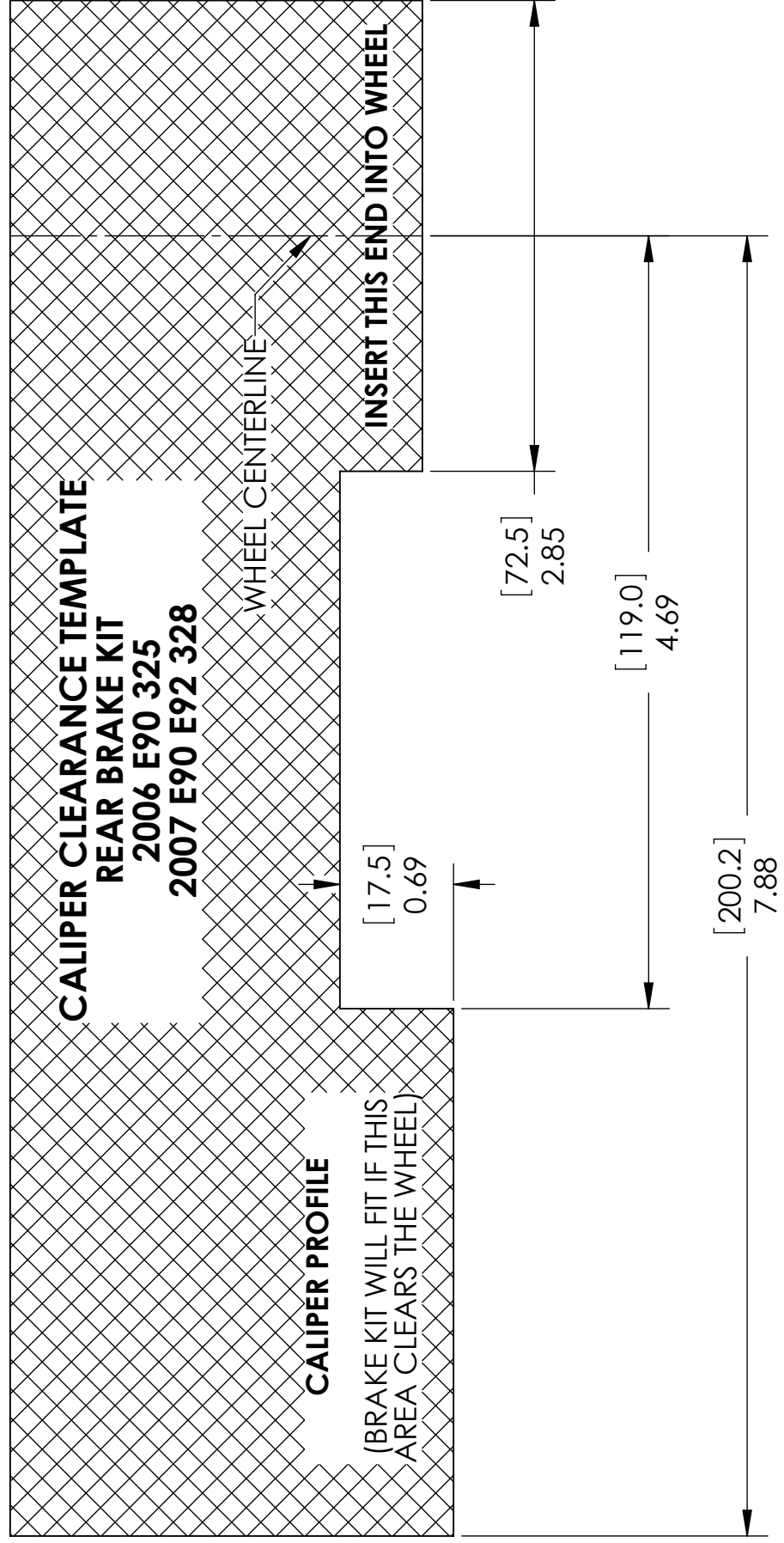



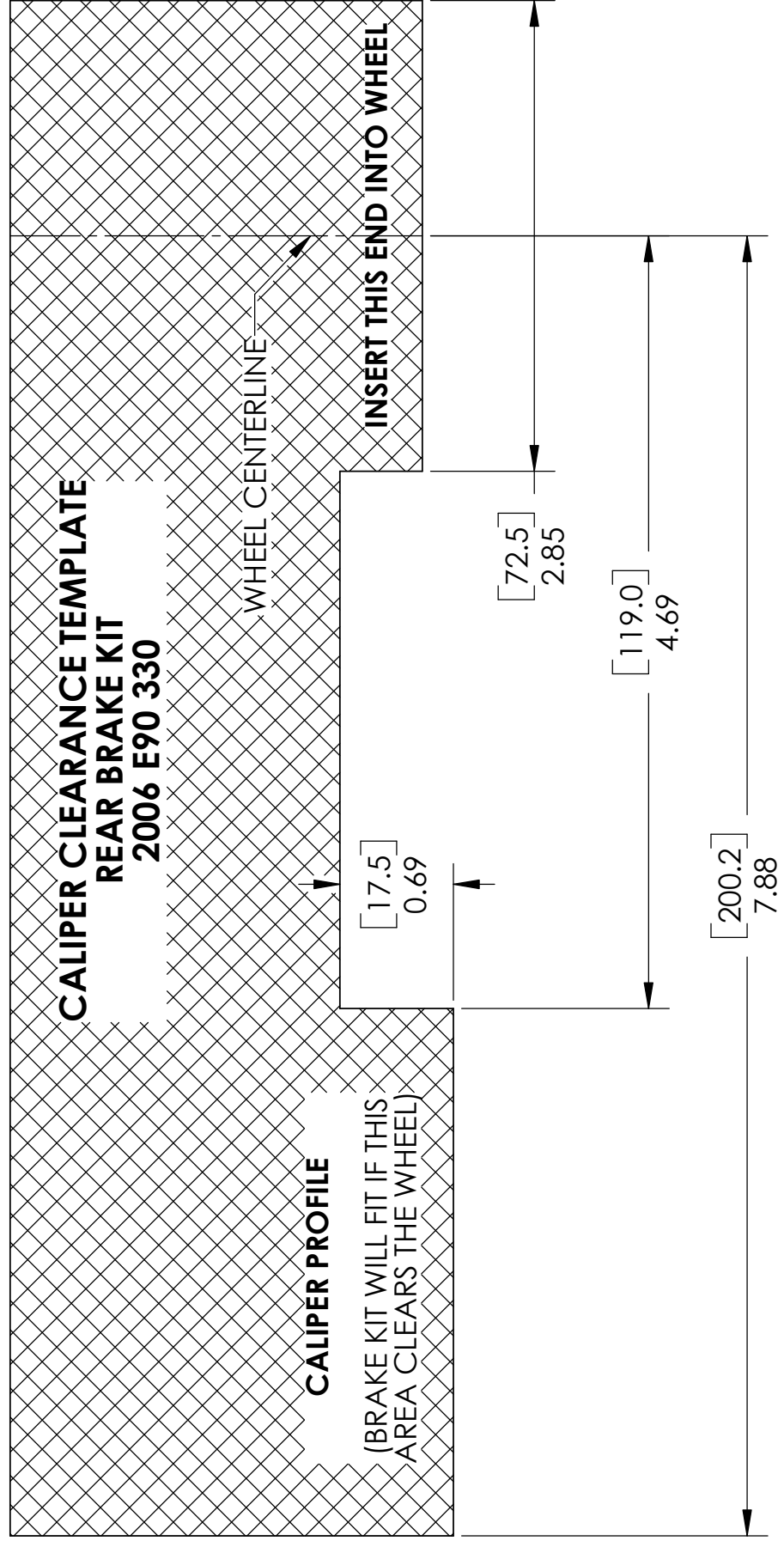

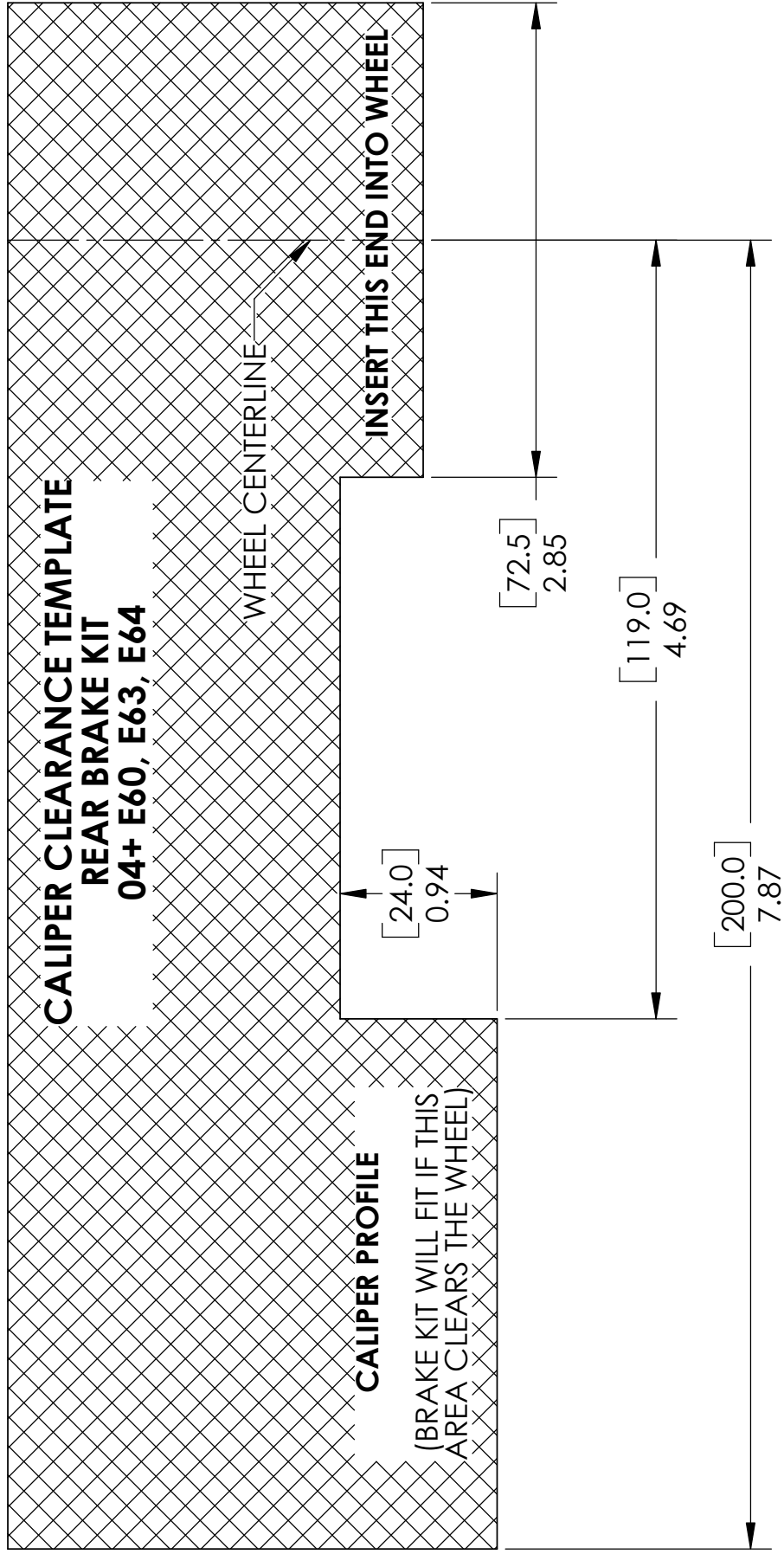

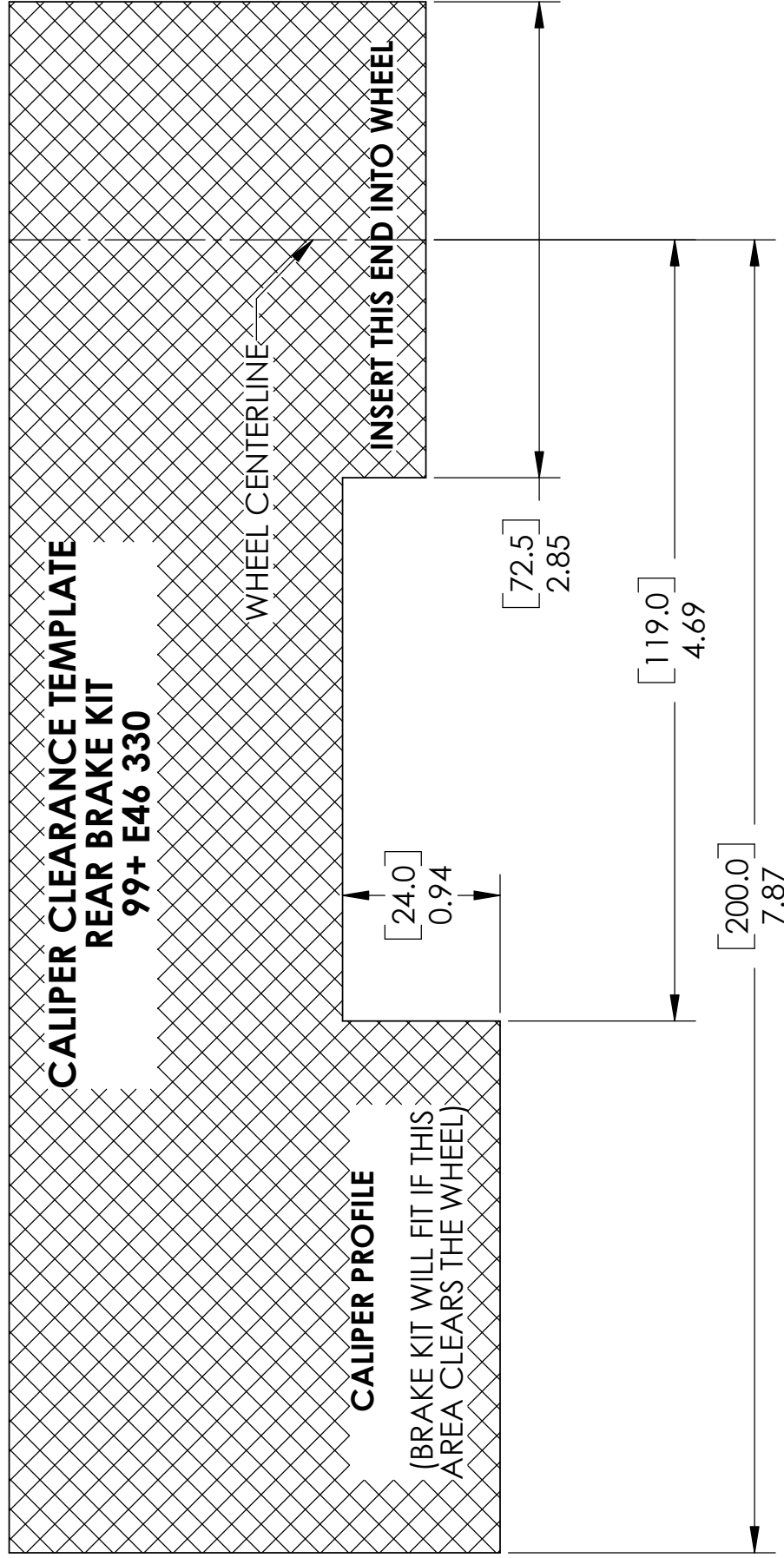

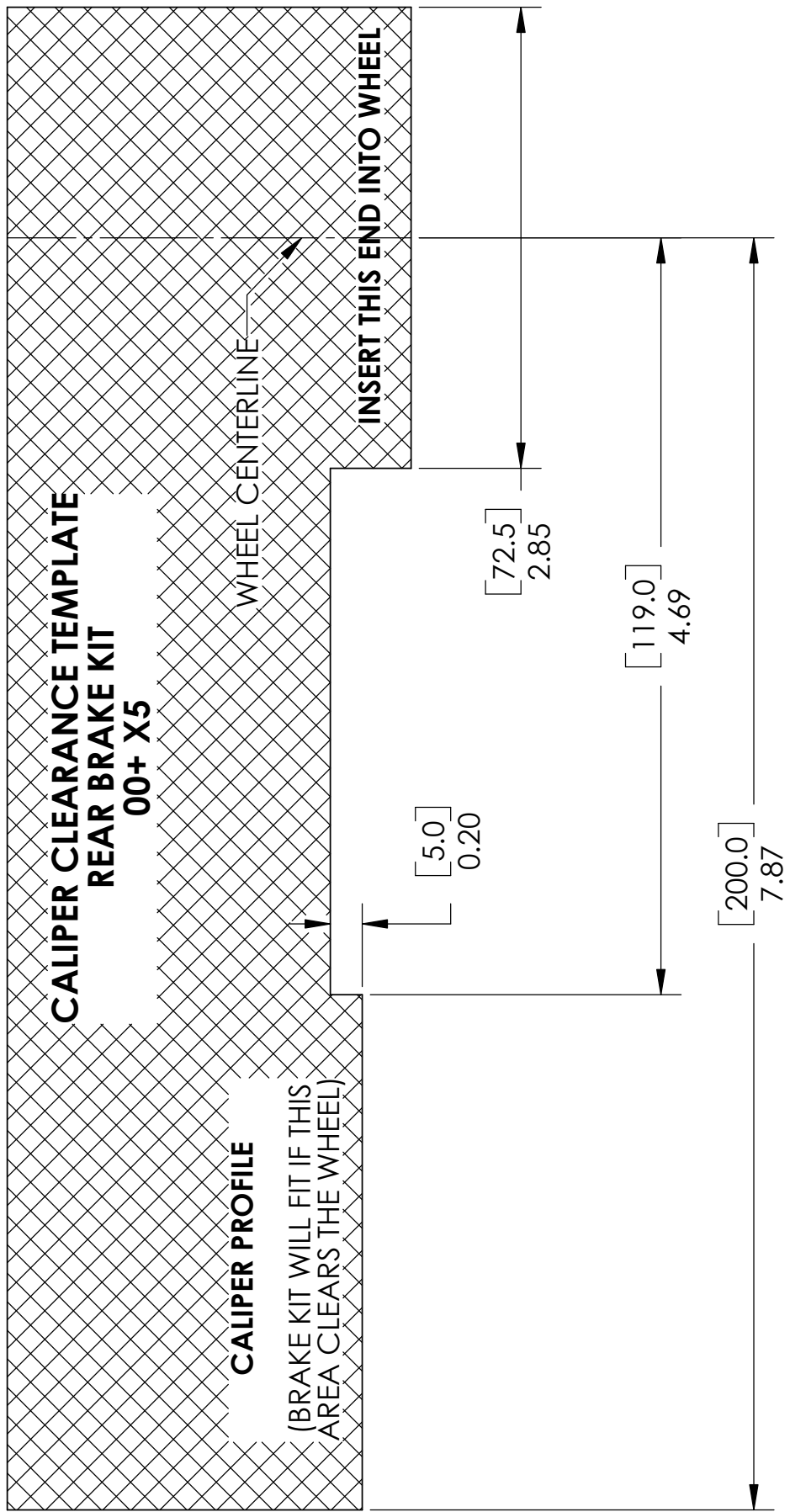

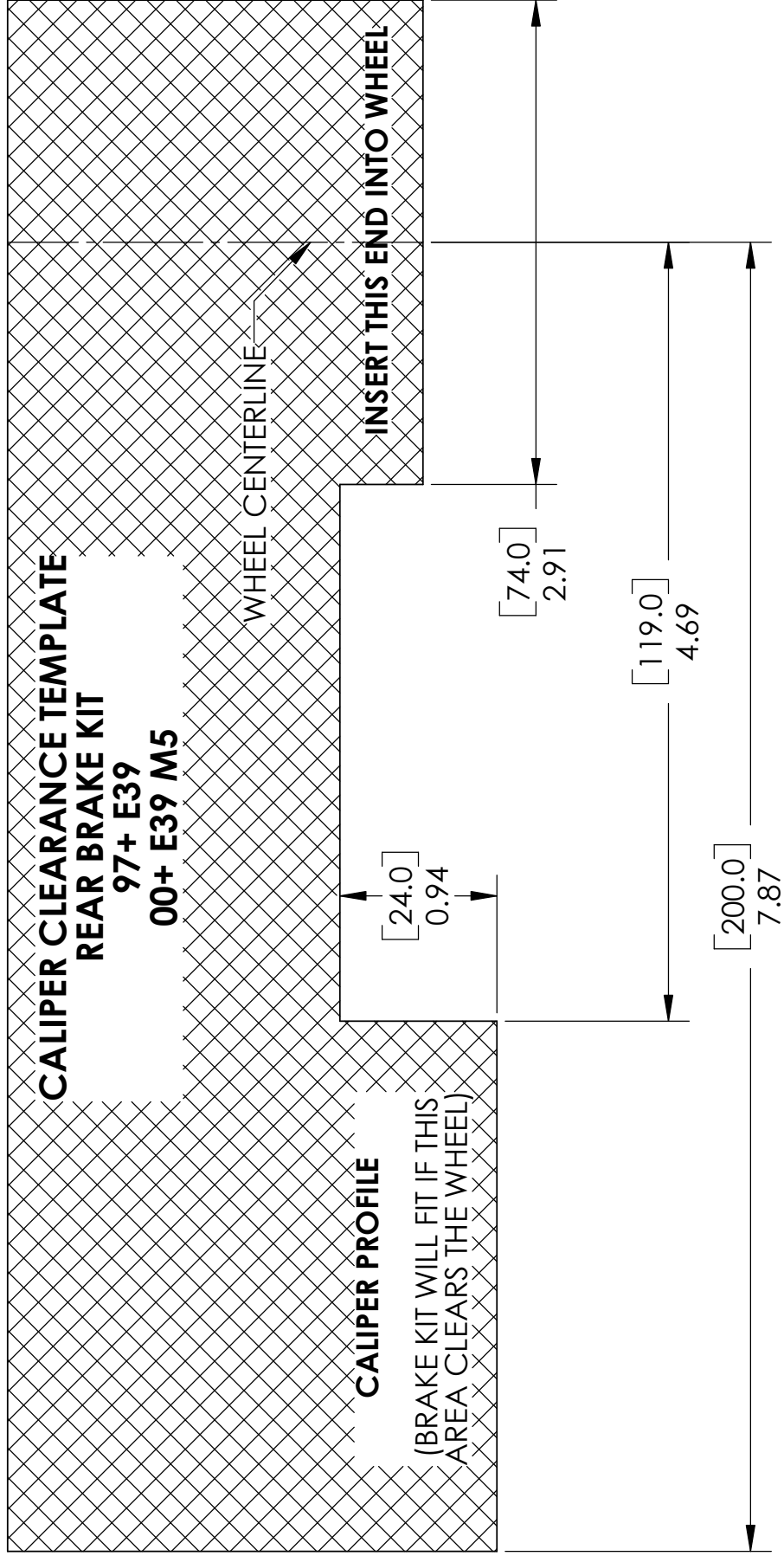

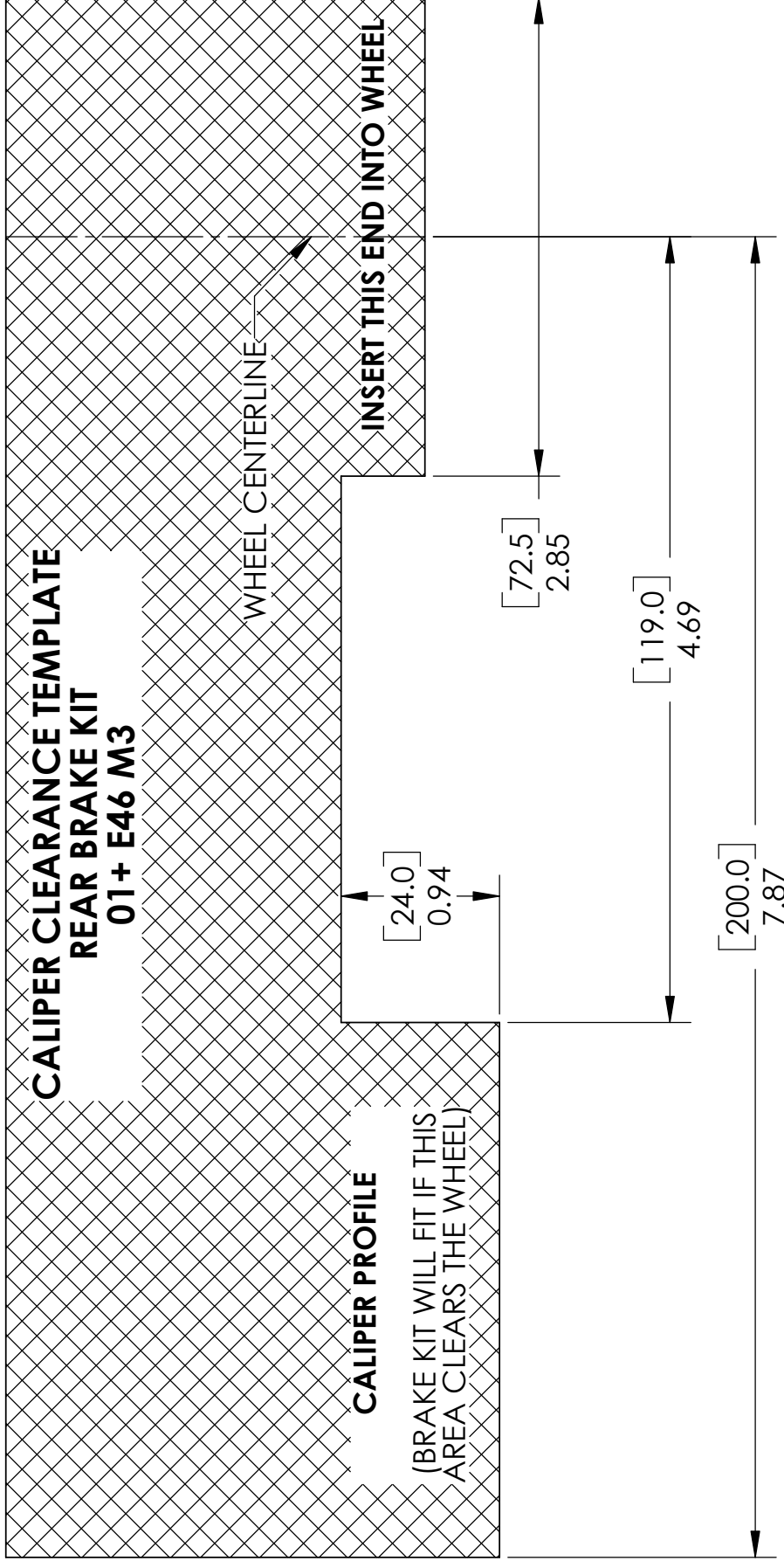

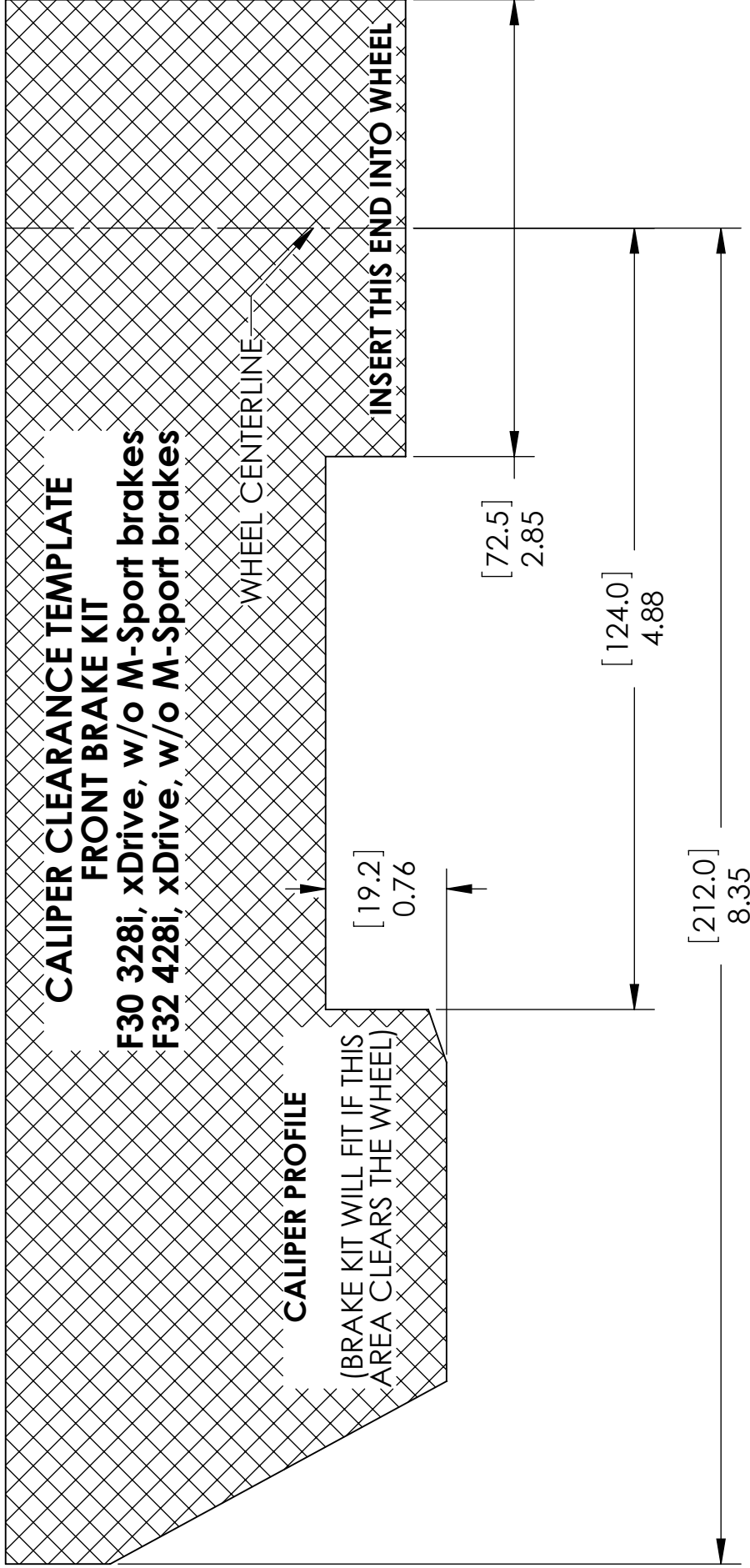

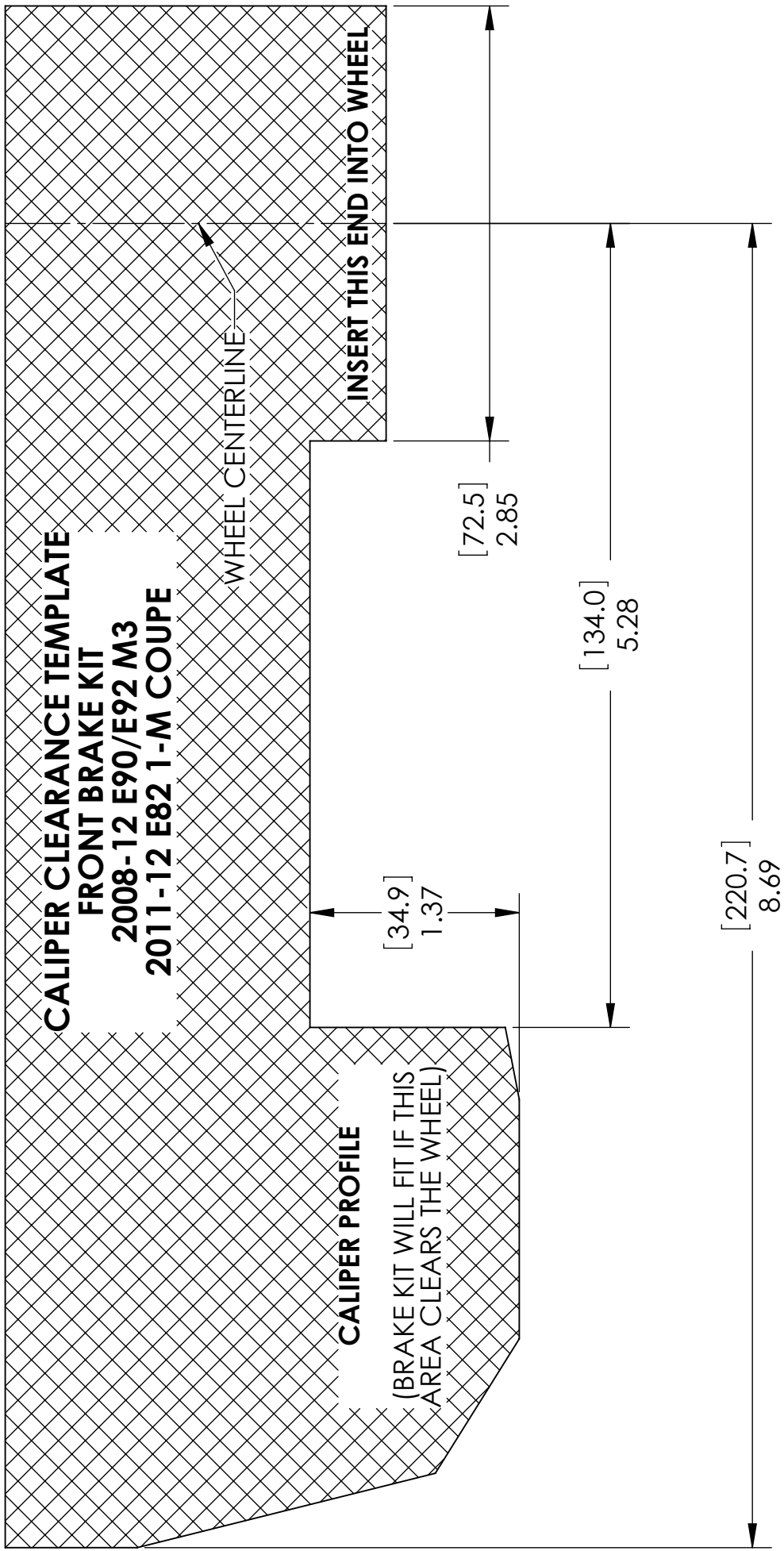

#D291-1N1.9003  
 #D291-1N2.9003



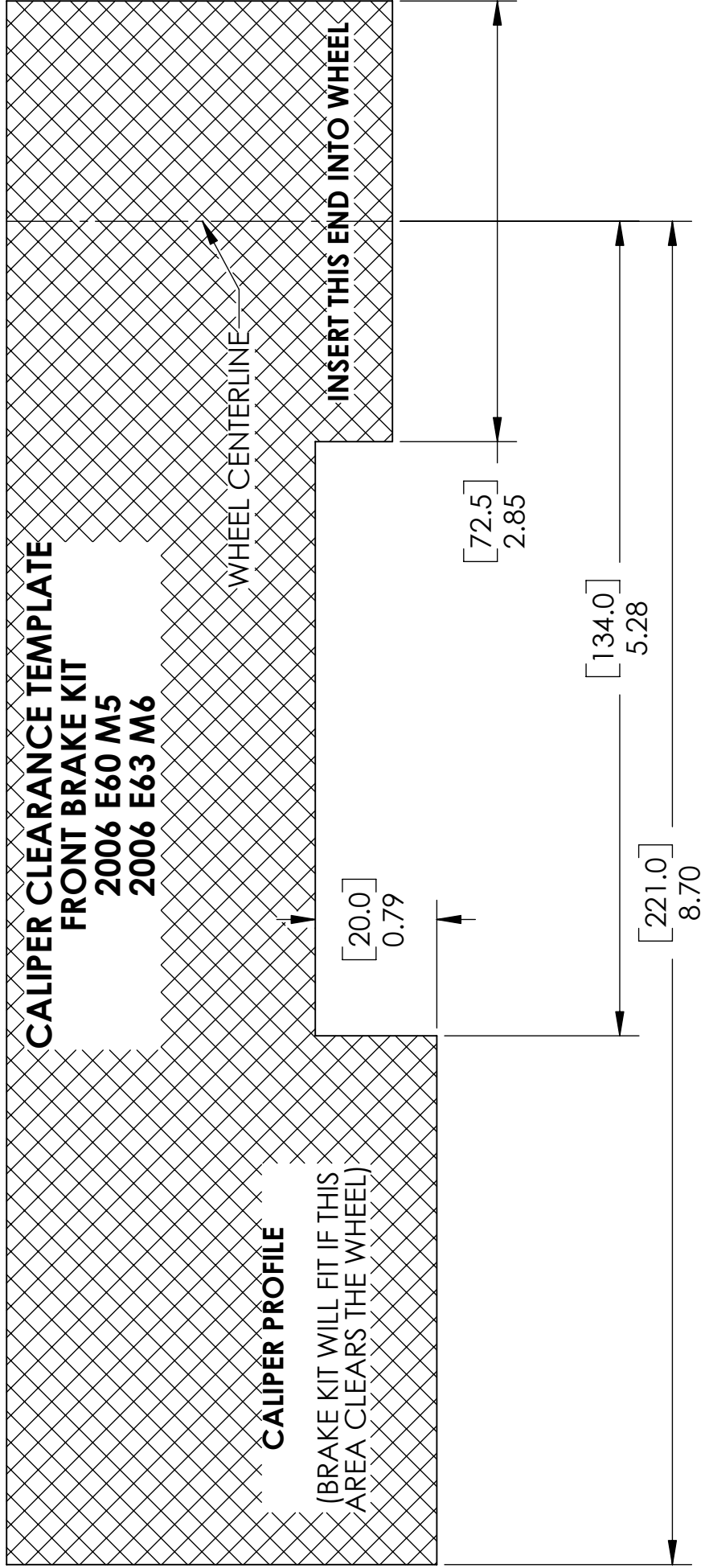

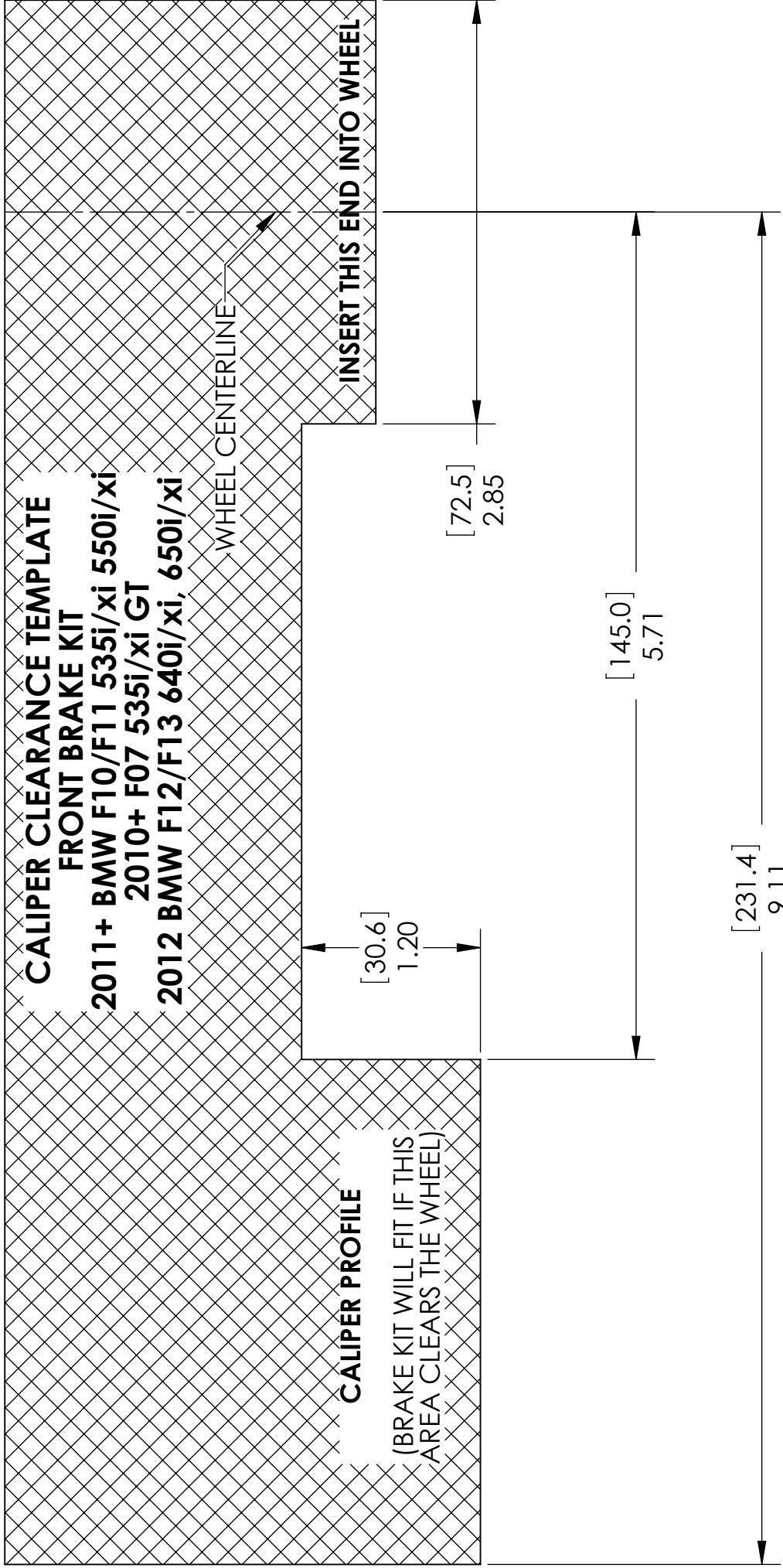

#D291-1IN1.9524  
 #D291-1IN2.9524

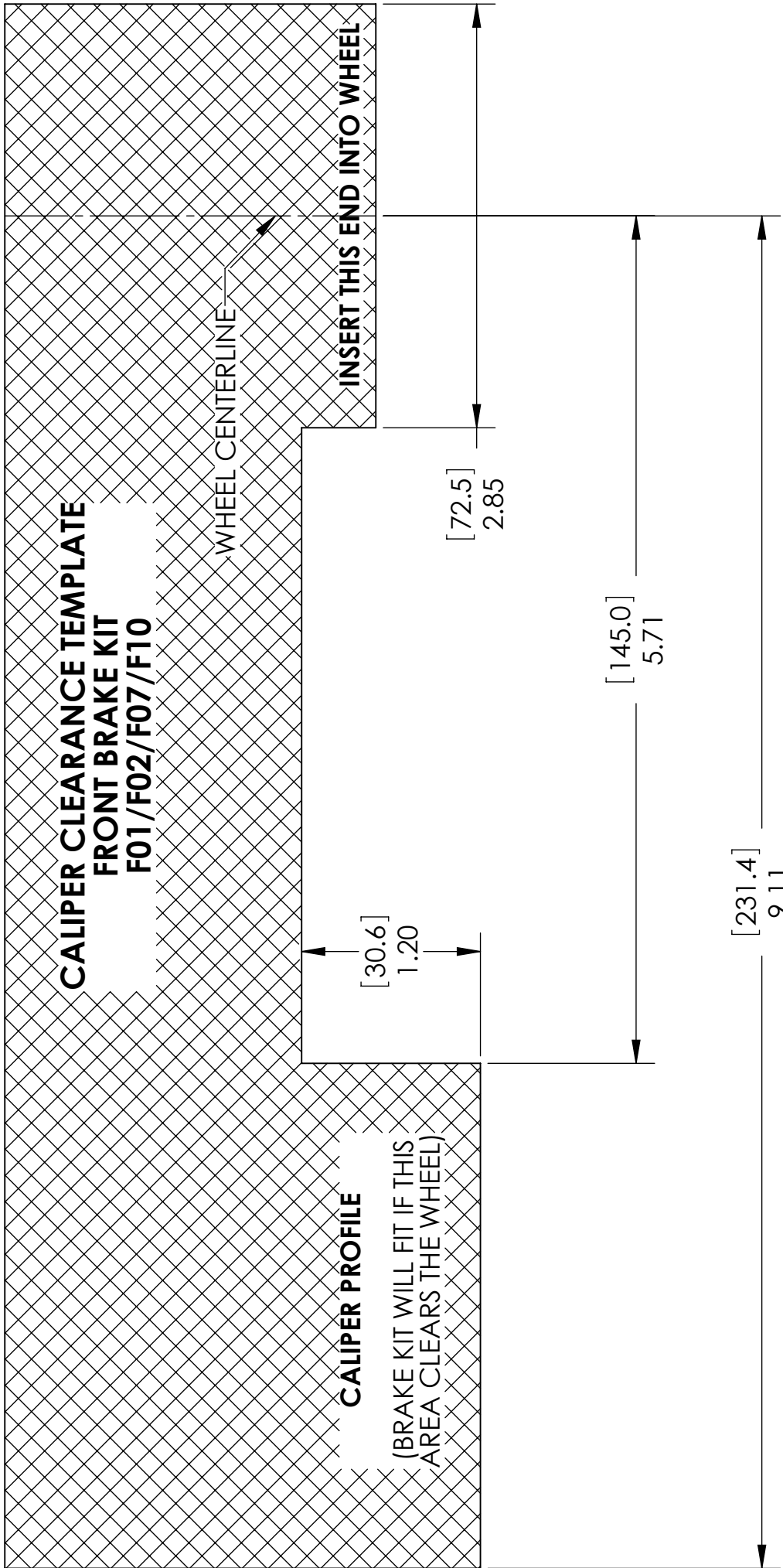

#D291-1IN1.9516  
 #D291-1IN2.9516

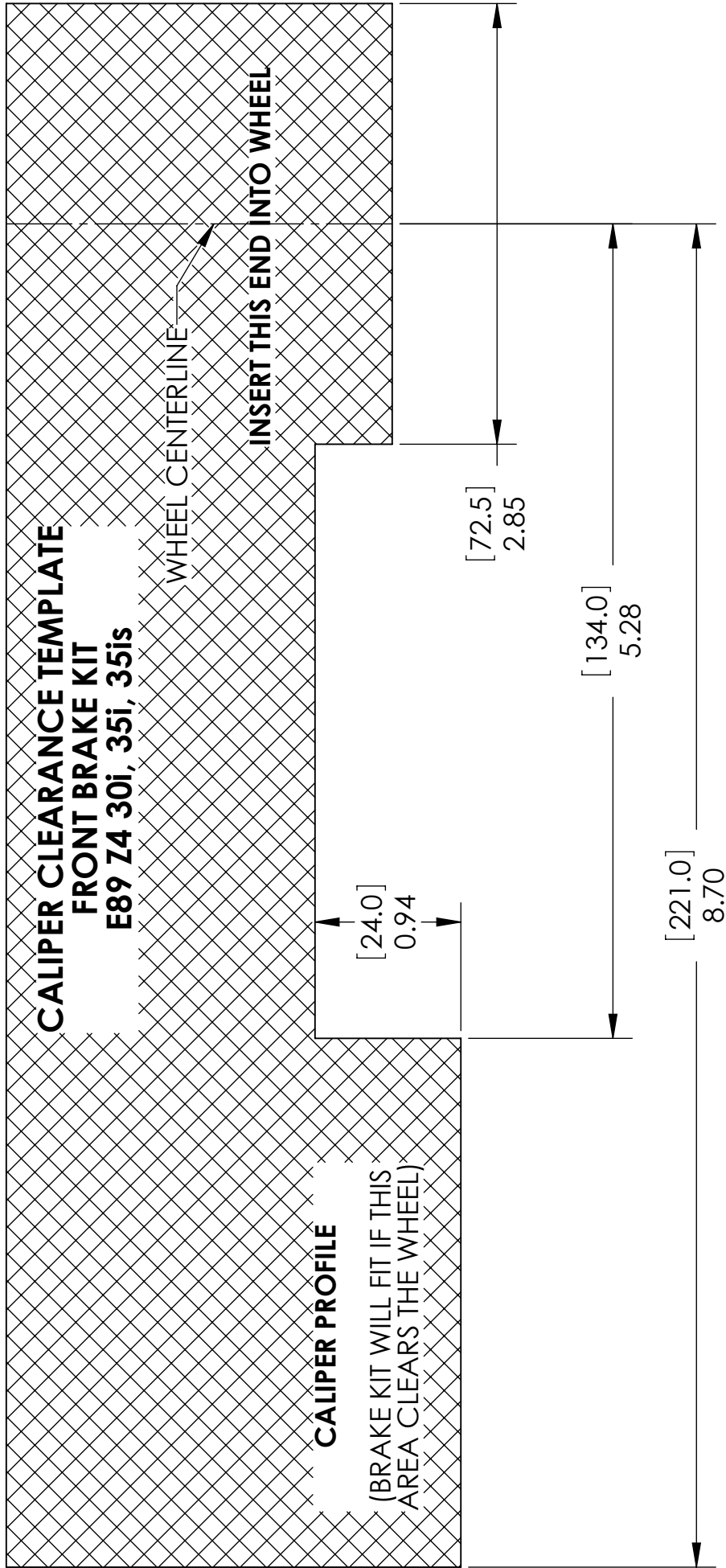

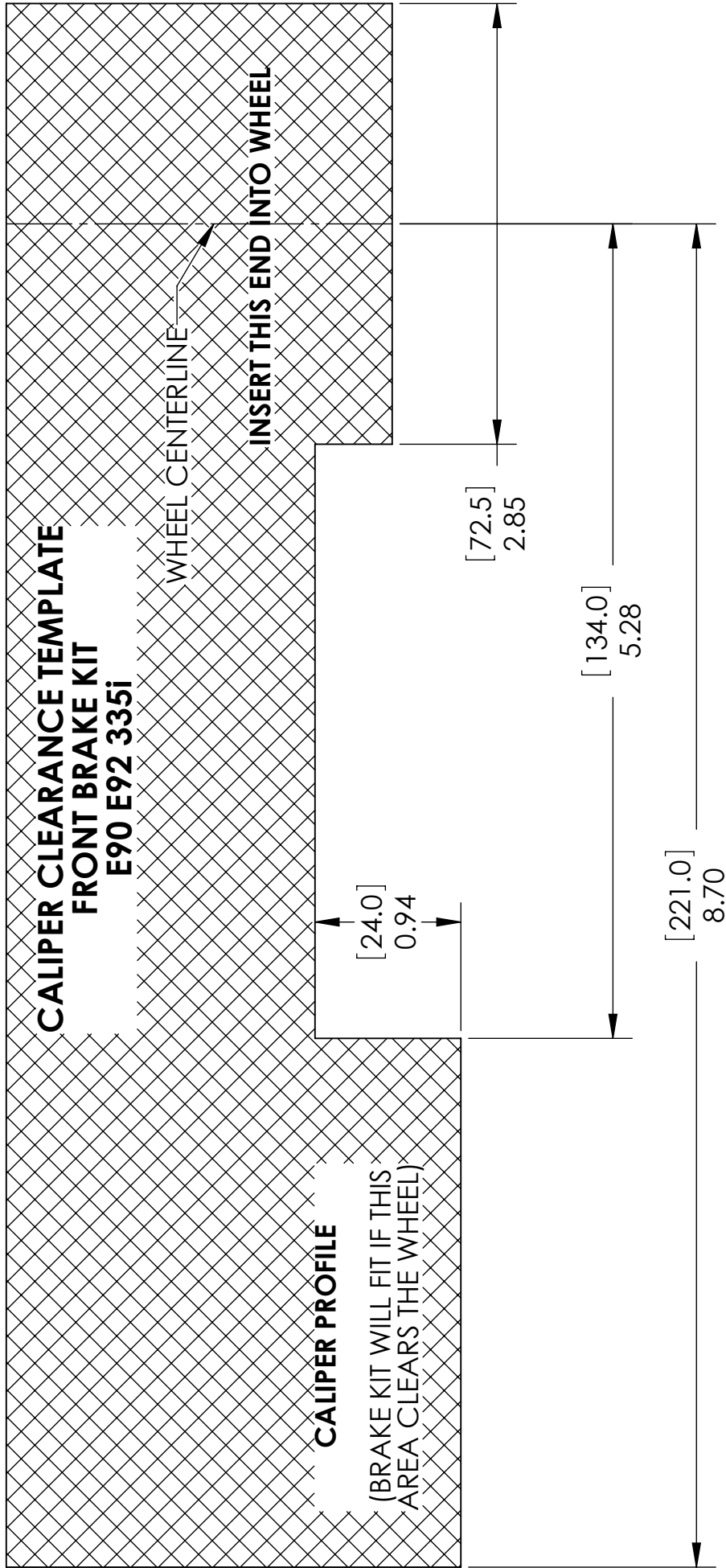

#D291-1M1.9014  
#D291-1M2.9014

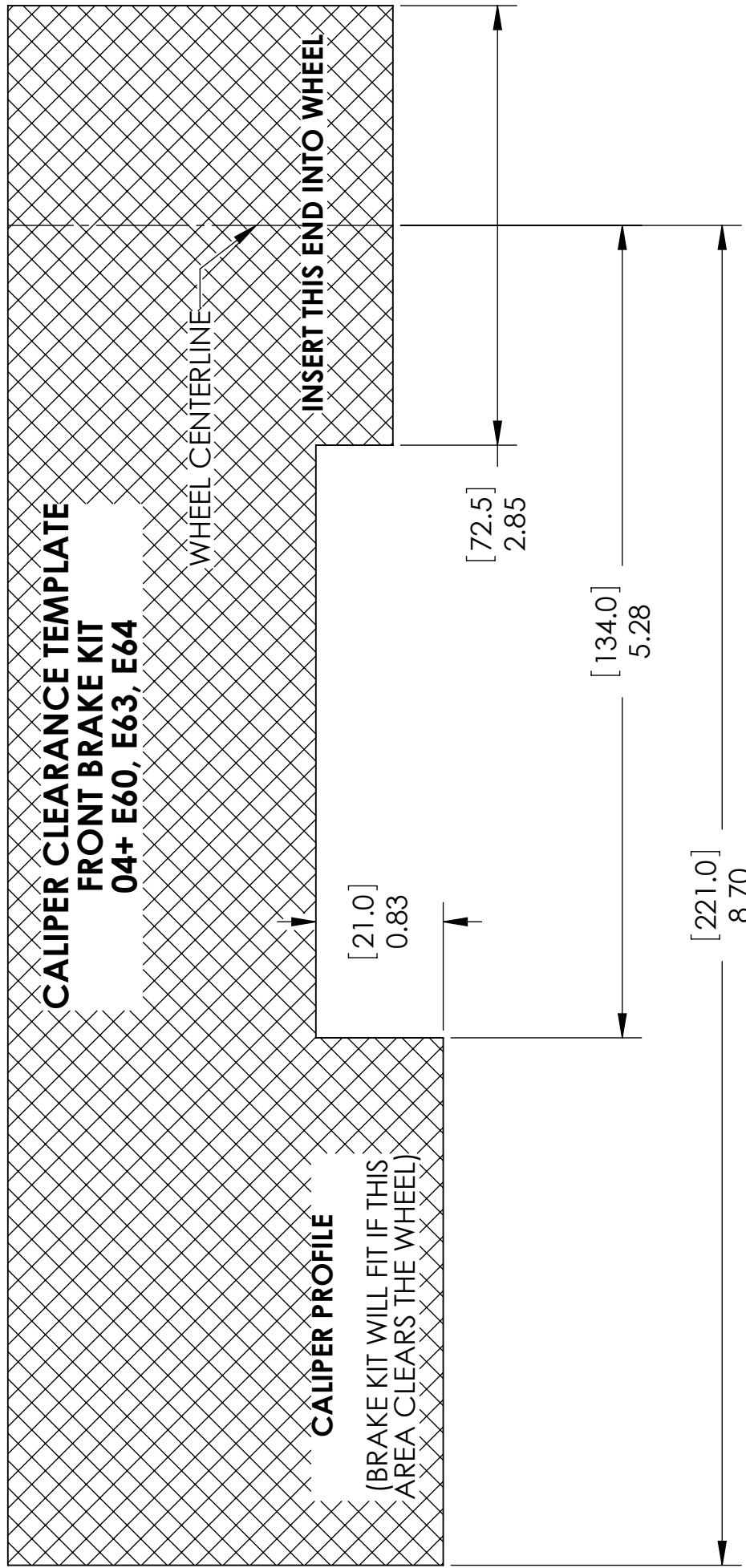

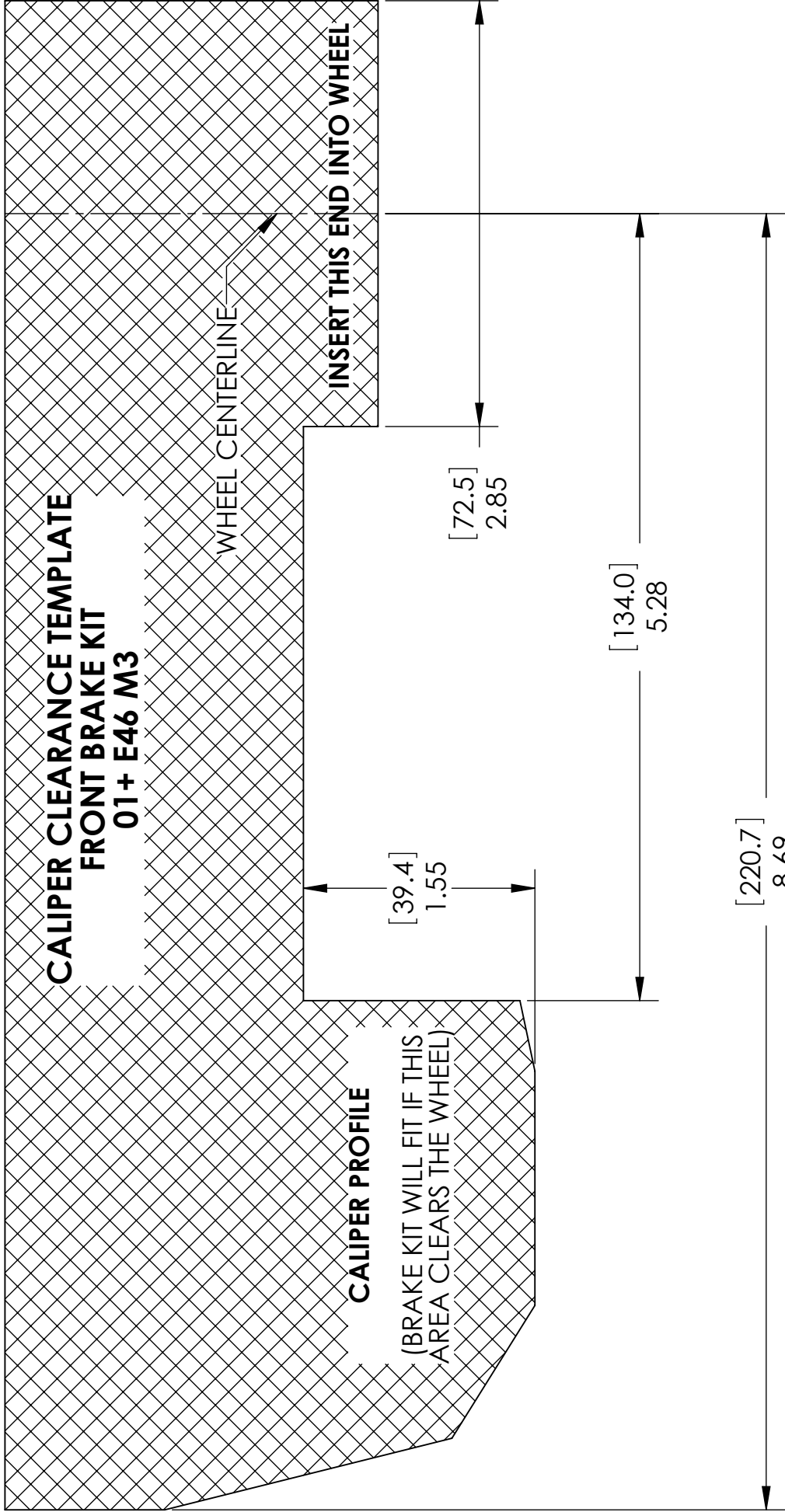

#D291-1M1.9001  
#D291-1M2.9001

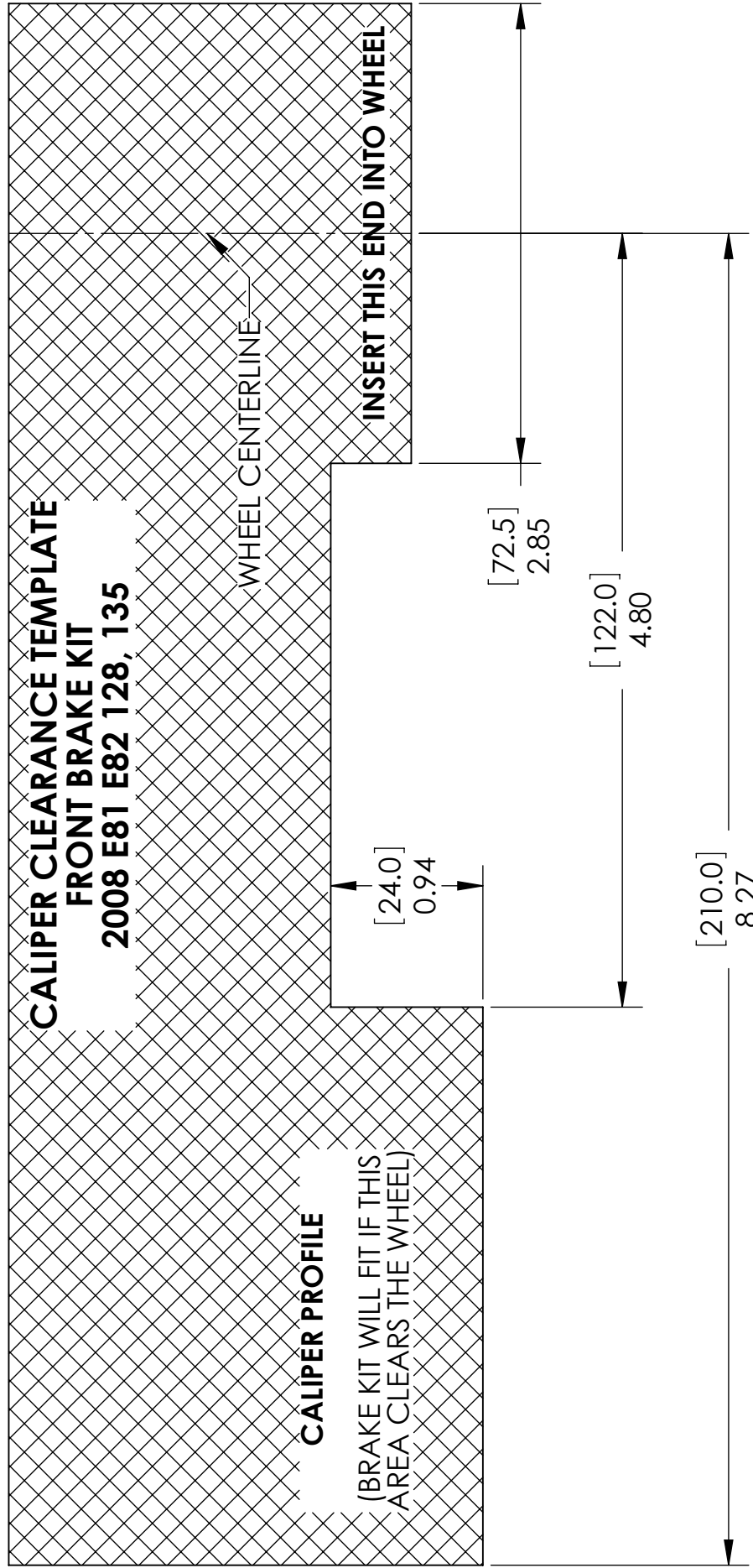



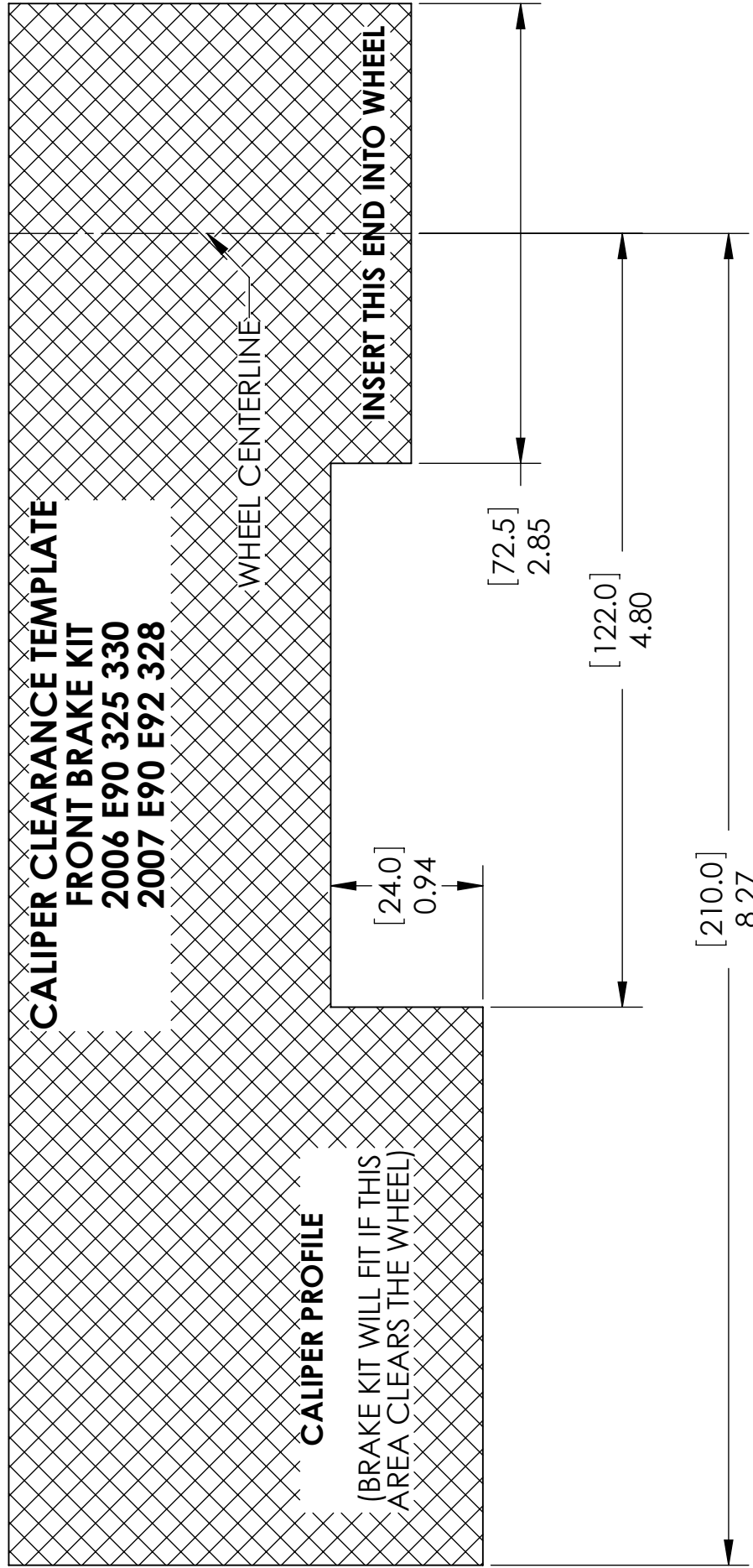

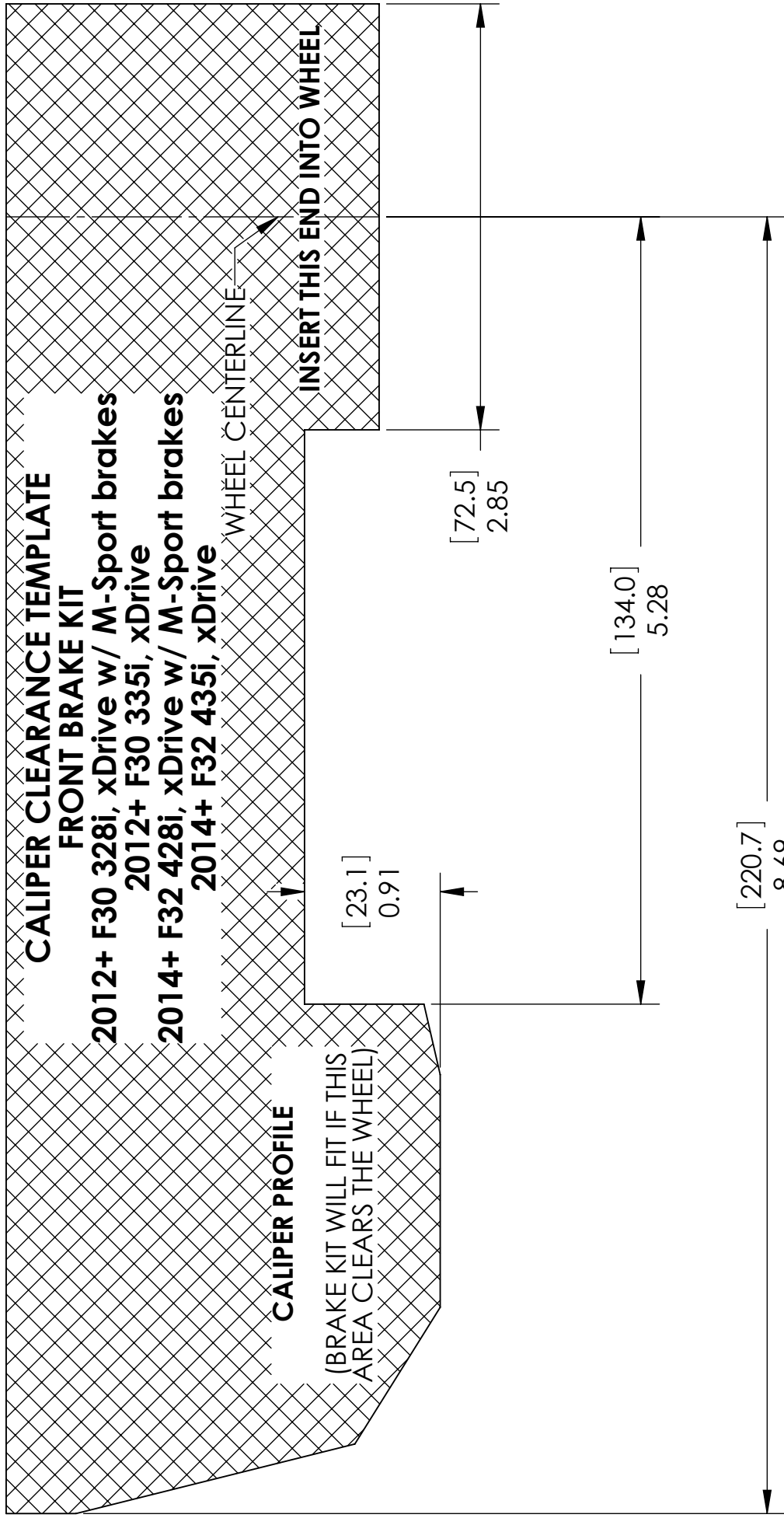

#D291-1M1.9041  
#D291-1M2.9041

