

#TL100117

INSTALLATION MANUAL

# DPK0028

APR 2.5T MQB Downpipe

**APR**





---

Notes:

These instructions were written for a North American-specification TT-RS. Other vehicles, like the RS3, are similar.

When disassembling the car, be sure to keep all fasteners so they can be reused. It is recommended that you get some kind of compartmented tray to organize the fasteners, such as a fishing tackle box or several large ice cube trays. Fasteners that are not reused for reinstallation are noted in the instructions. All directions used in this manual (right, left, front, etc.) are based on if you were sitting in the driver's seat of the car.

These instructions assume that you have basic mechanical skills and several varieties of basic hand tools in order to install the kit. If you have any questions about the install, feel free to contact your APR representative.



WWW.GOAPR.COM

4800 US HWY 280 West Opelika Alabama 36801

**TL100117**

---



1) Securely lift the car using an auto lift or a jack and jackstands, then remove the front wheels.

***APR***

2) In the drivers footwell, remove the two 10mm nuts holding the carpet down.

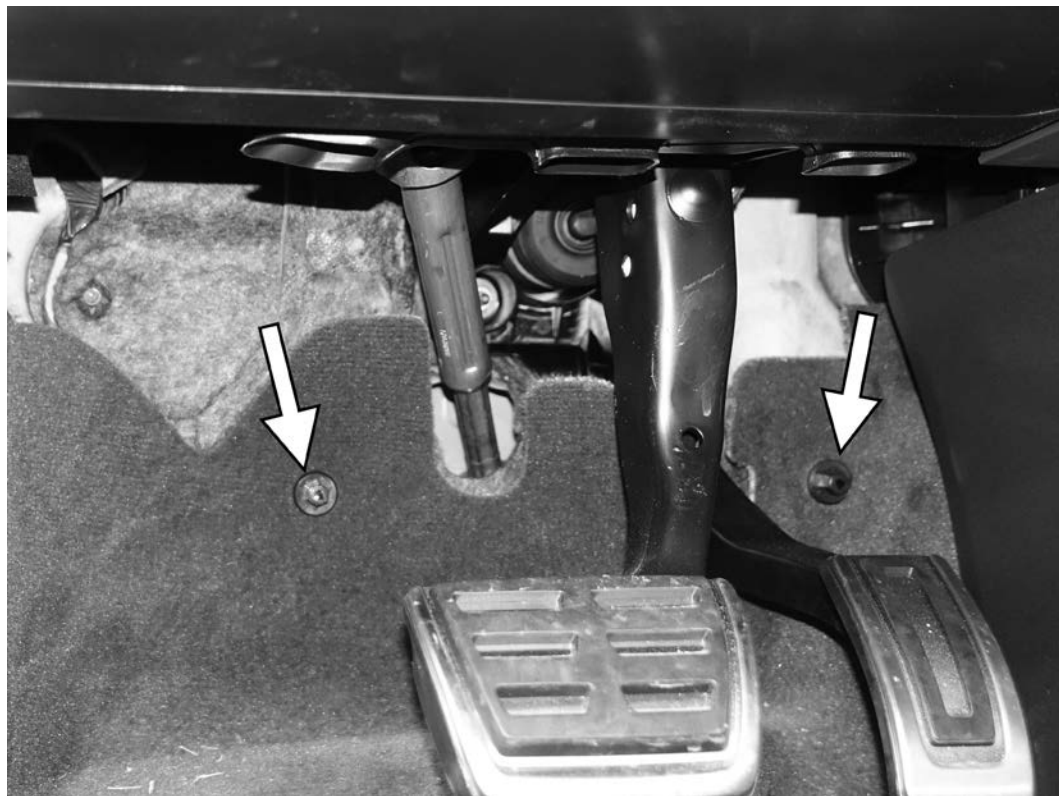

**TL100117**



3) After making sure the steering wheel is centered, fold down the carpet, and remove the 13mm bolt holding the steering column to the steering shaft. Lift up on the steering column to separate it from the steering shaft.

4) Remove the engine cover by lifting up on the corners of the cover. Remove the stock intake tube by first removing the hose clamp between the accordion hose and the airbox. Then disconnect the Norma style fitting from the crankcase solenoid valve (N546). Remove the spring clamp from the intake to the stock compressor inlet pipe. Finally, on the back side of the intake tube, remove the T30 screw holding the tube to the cylinder head and remove the intake tube with the accordion hose.





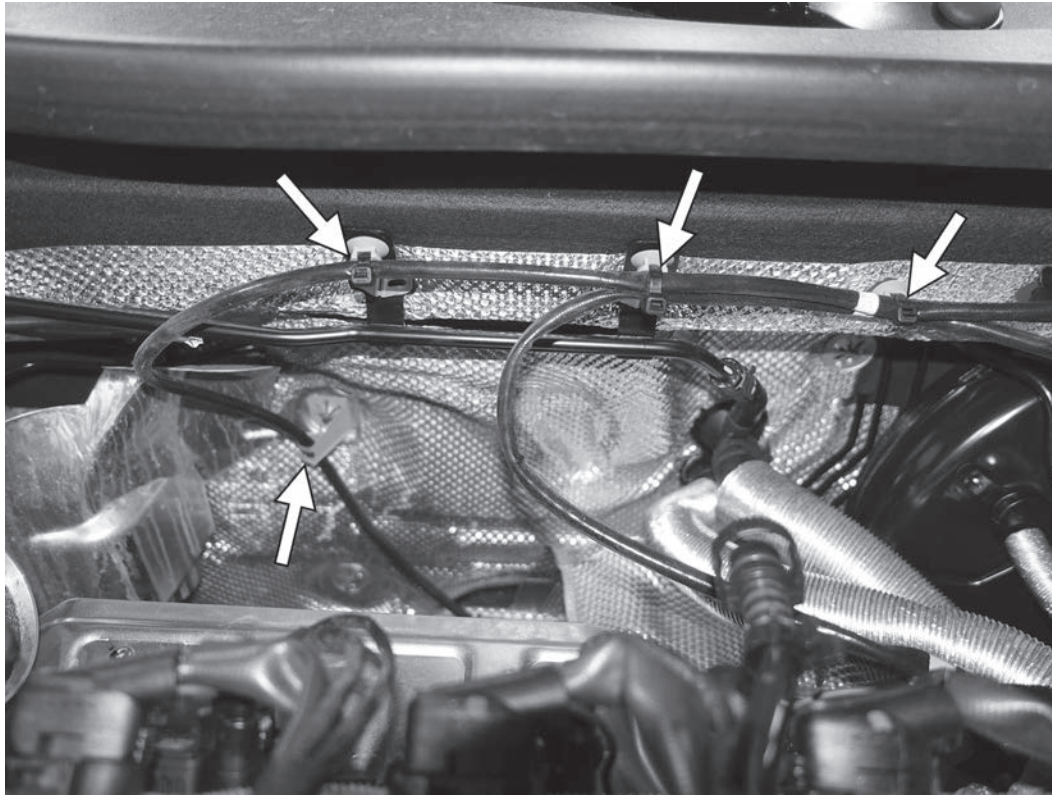

5) Cut the three cable ties holding the oxygen sensor wires to the firewall of the car. Separate the sensor wires from these clips, leaving the clips in the car, and from the bracket further down on the firewall.

**APR**



6) Remove the two connectors for both oxygen sensors from the bracket on the back of the firewall. Disconnect both oxygen sensor connectors.



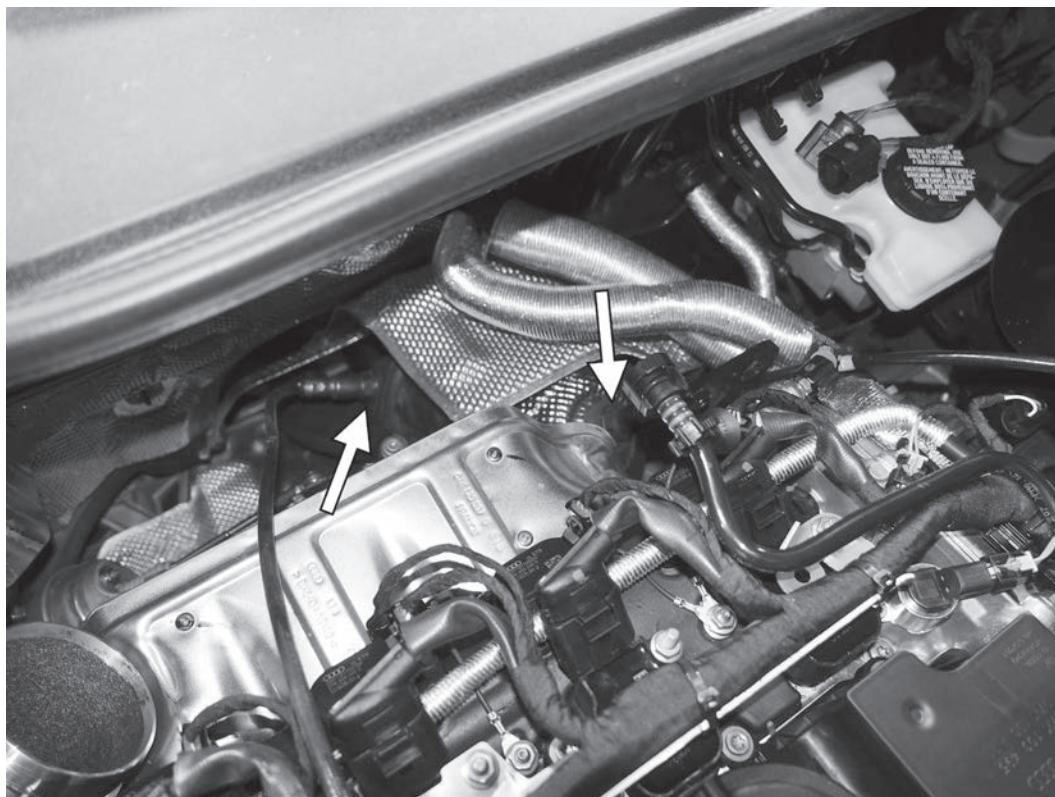

7) Remove both oxygen sensors from the exhaust using an oxygen sensor socket.

8) Fully loosen the T25 screw on the turbo to downpipe V-Band clamp. Do not remove the clamp at this point.



**TL100117**

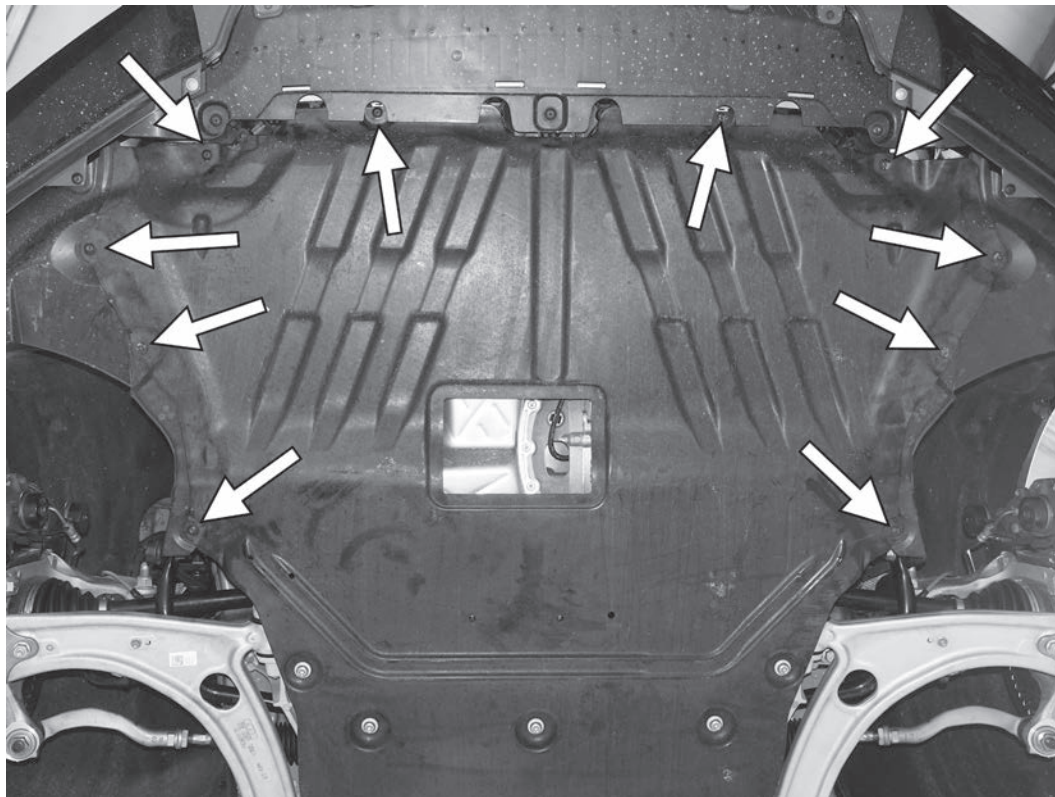

9) Remove the ten T25 screws holding the front of the belly pan in place.



10) Remove the two push pin style connectors from the back of the belly pan. With an assistant holding the belly pan, remove the five T45 screws in the middle of the belly pan, and remove the it from the car.

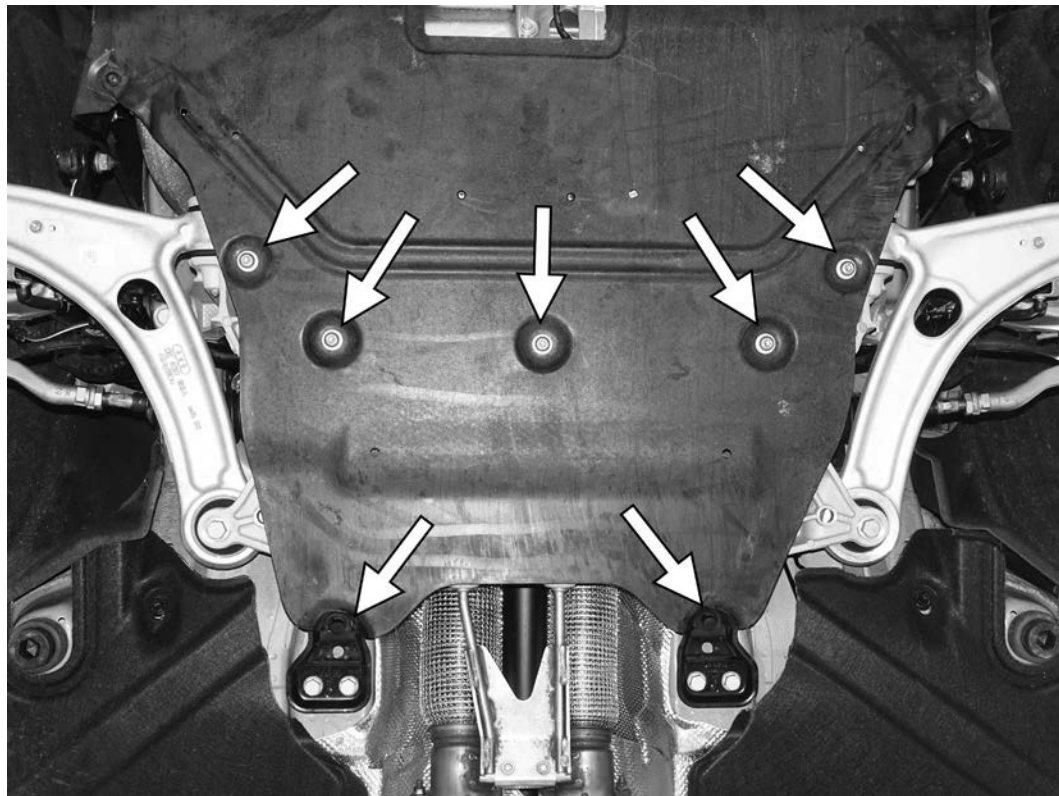

**TL100117**

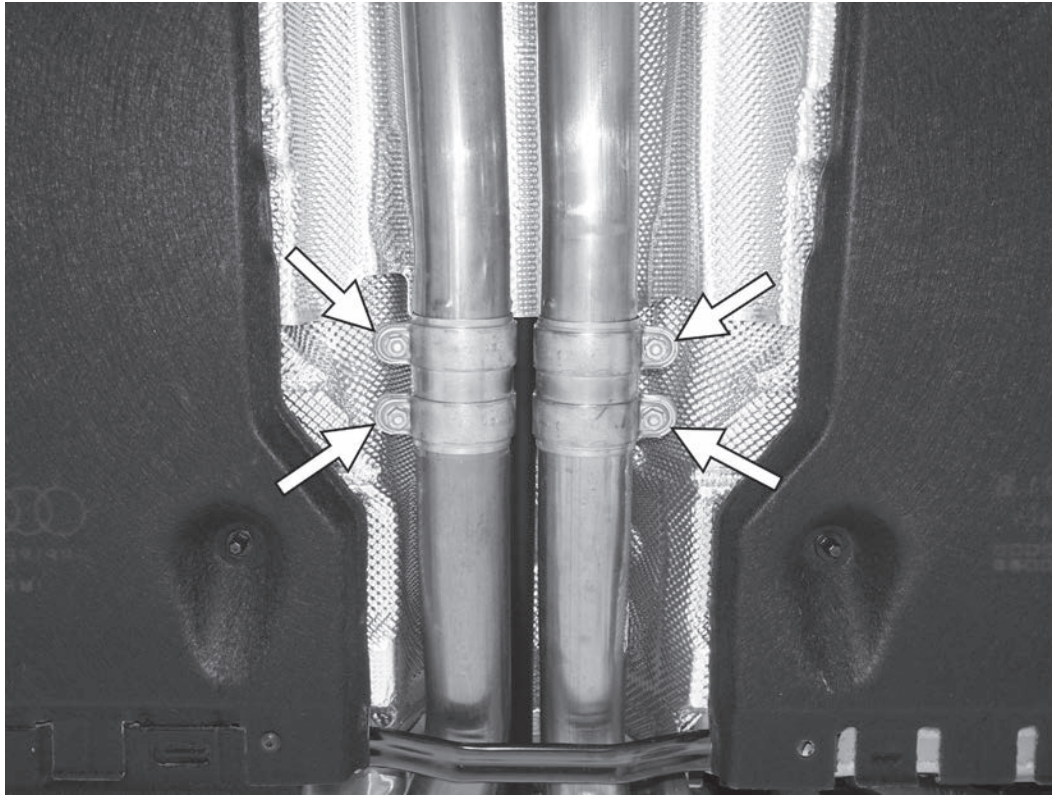

11) Remove the four 13mm nuts from the two exhaust clamps near the back of the center tunnel.

12) Remove the six (three shown in picture) 12mm nuts holding the two midpipes to the car, and remove the midpipes from the car.

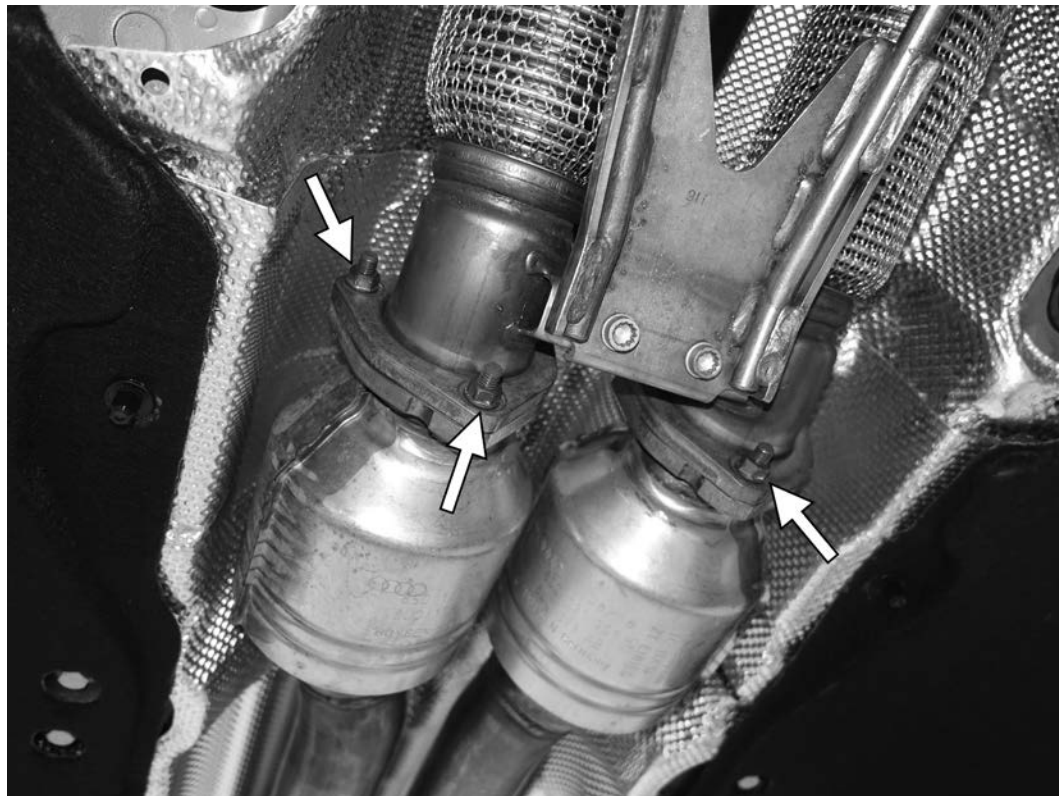

**TL100117**



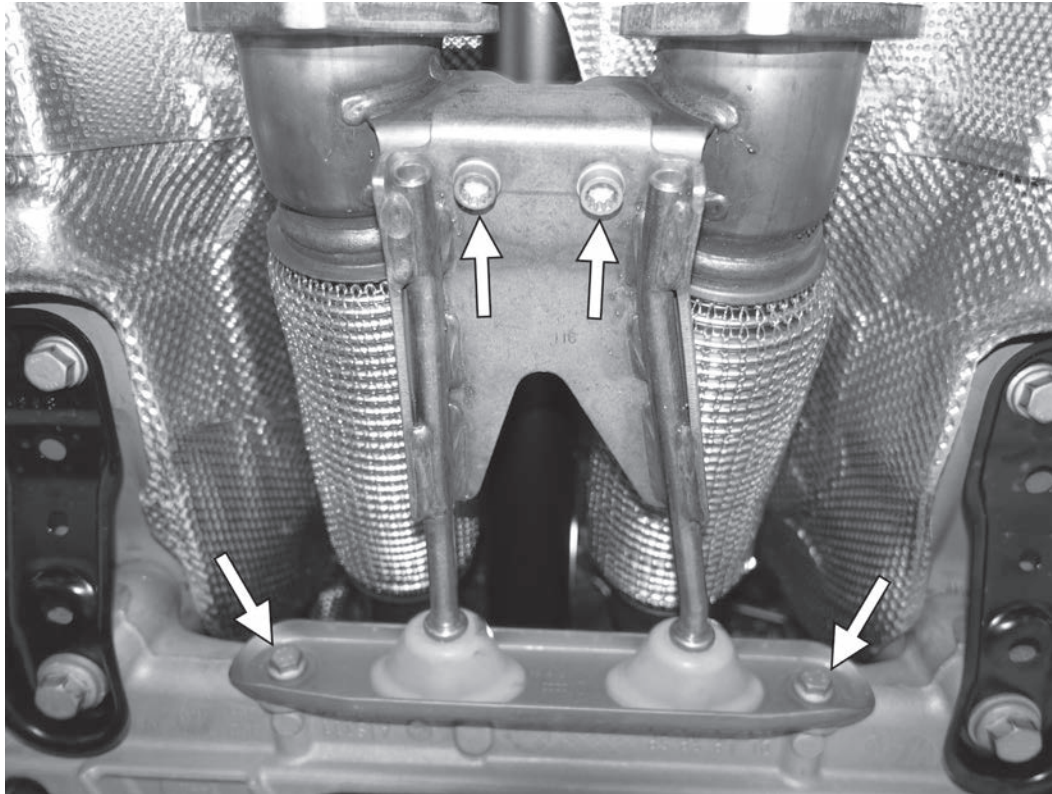

13) Remove the two 10mm triple square screws holding the exhaust bracket to the flanges on the downpipes. Remove the two 13mm screws holding the exhaust mounting bracket to the subframe, and remove the entire exhaust mount.

14) The balljoint bracket to the lower control arm is slotted. After marking their position, remove the three 16mm nuts holding the ball joint bracket to the lower control arm. Remove the 21mm nut holding the tie rod to the upright. Repeat on the other side of the car.

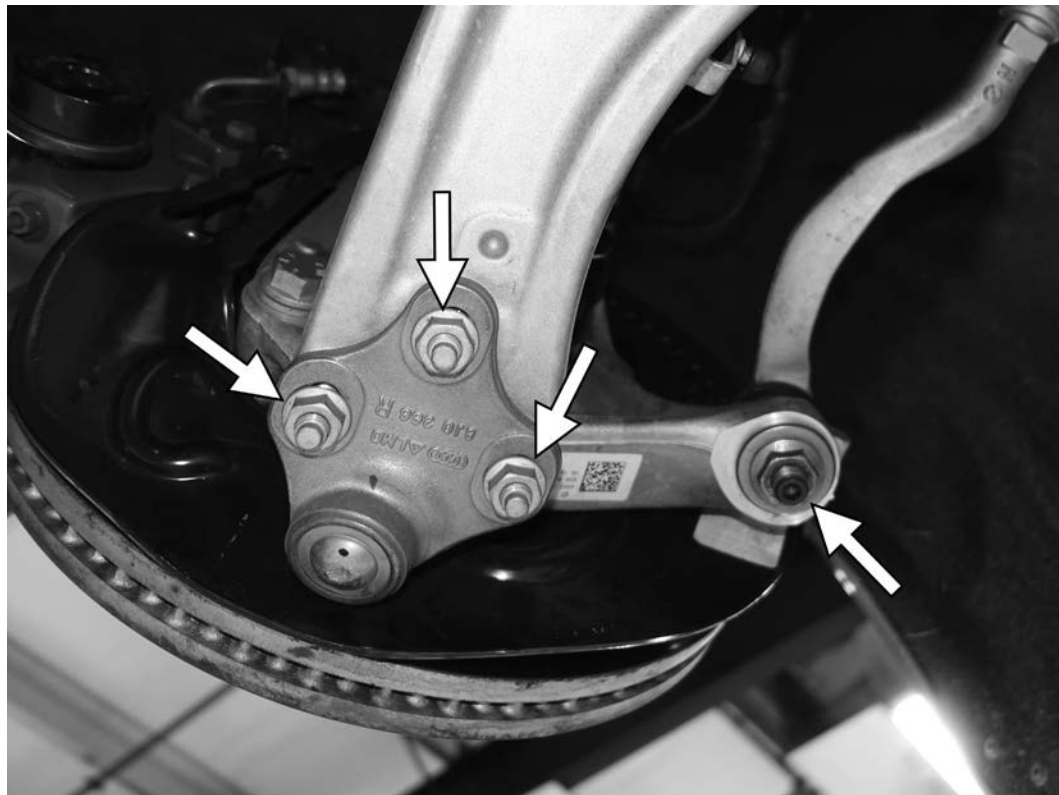

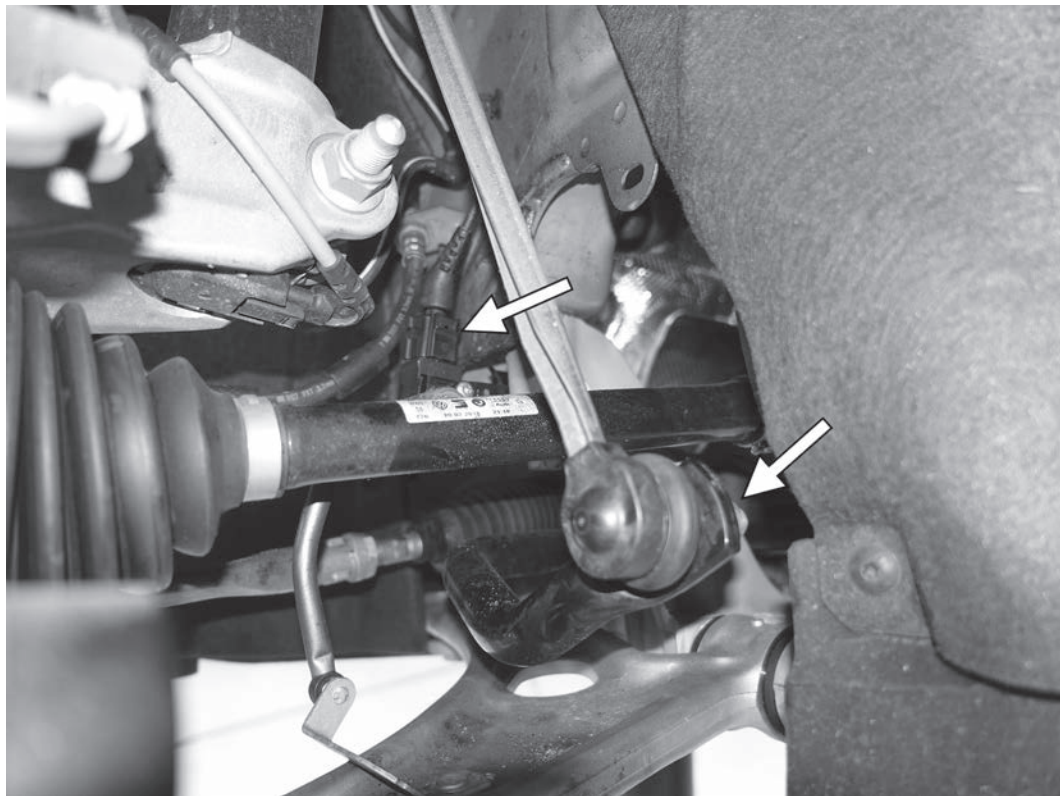

15) Remove the 18mm nut holding the sway bar to the sway bar endlink. Disconnect the electrical connector to the ride height sensor. Repeat on the other side of the car.

16) Remove the four 16mm screws holding the brackets on the back of the subframe to the chassis of the car.

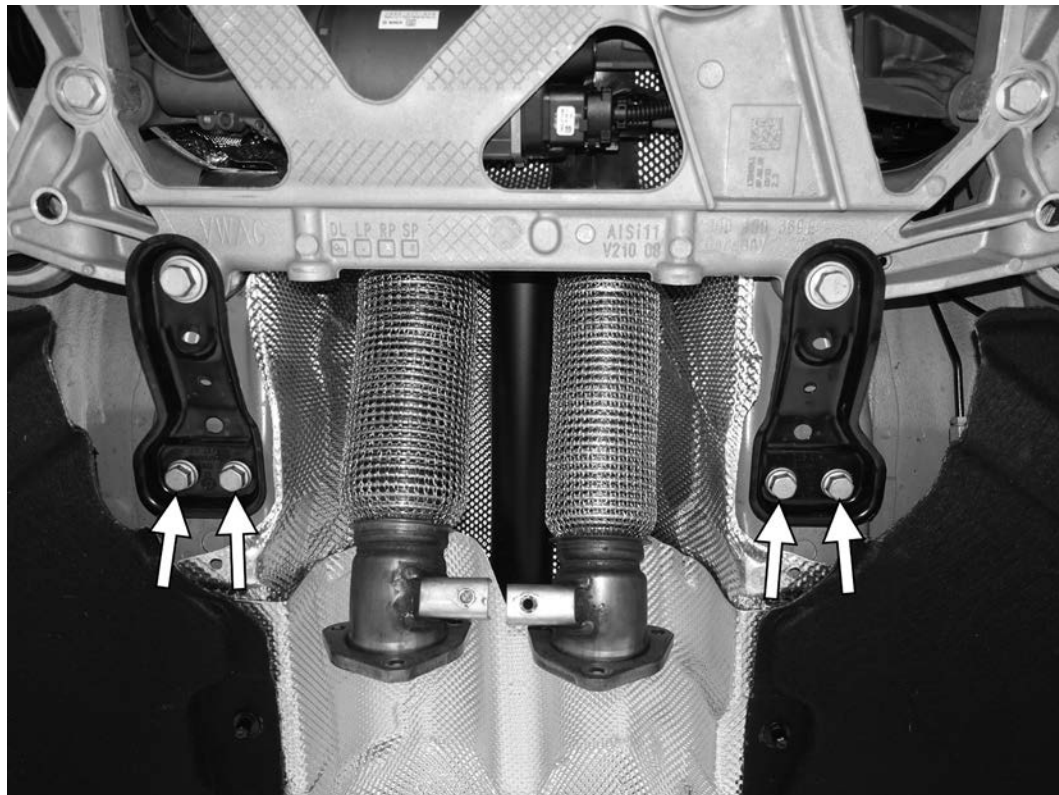

**TL100117**



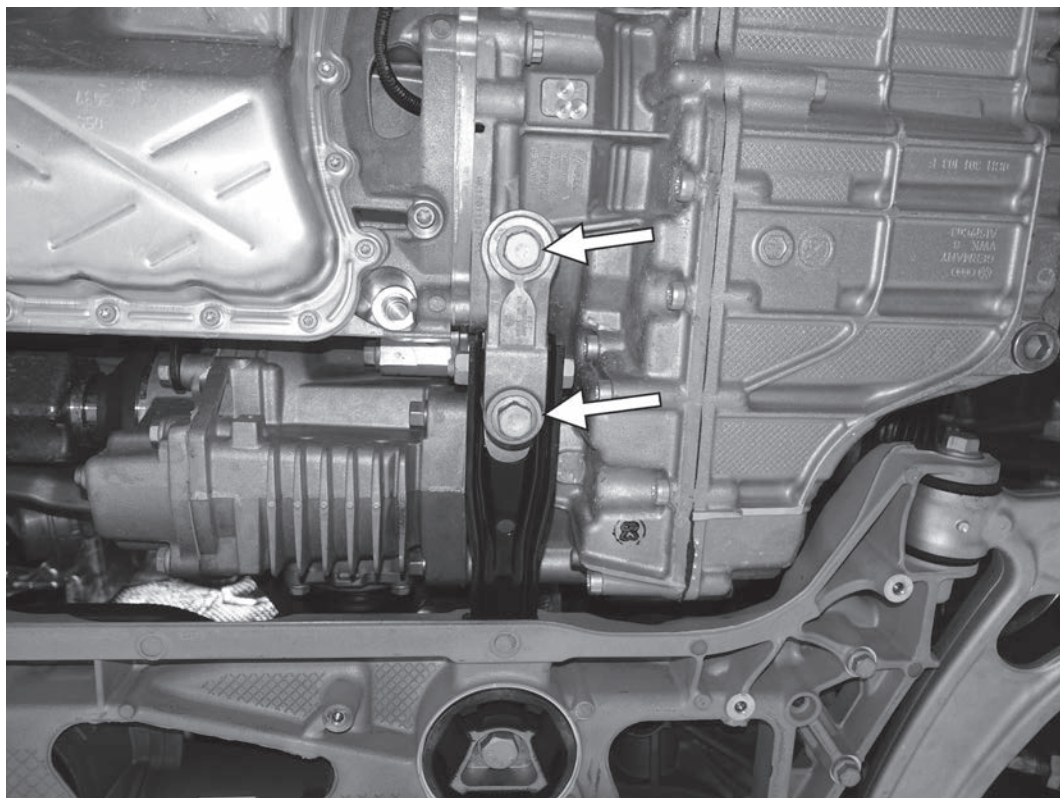

17) Remove the two 18mm screws holding the front portion of the lower engine mount to the transmission.

18) Use a transmission jack to support the front subframe.

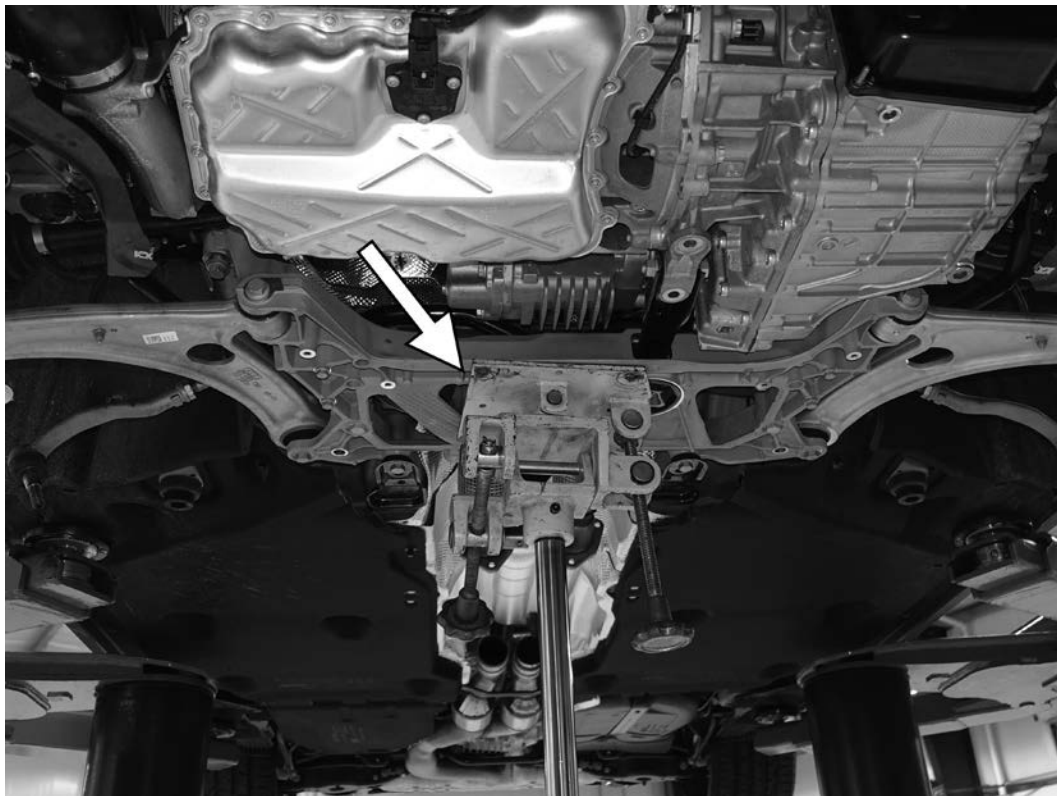

**TL100117**

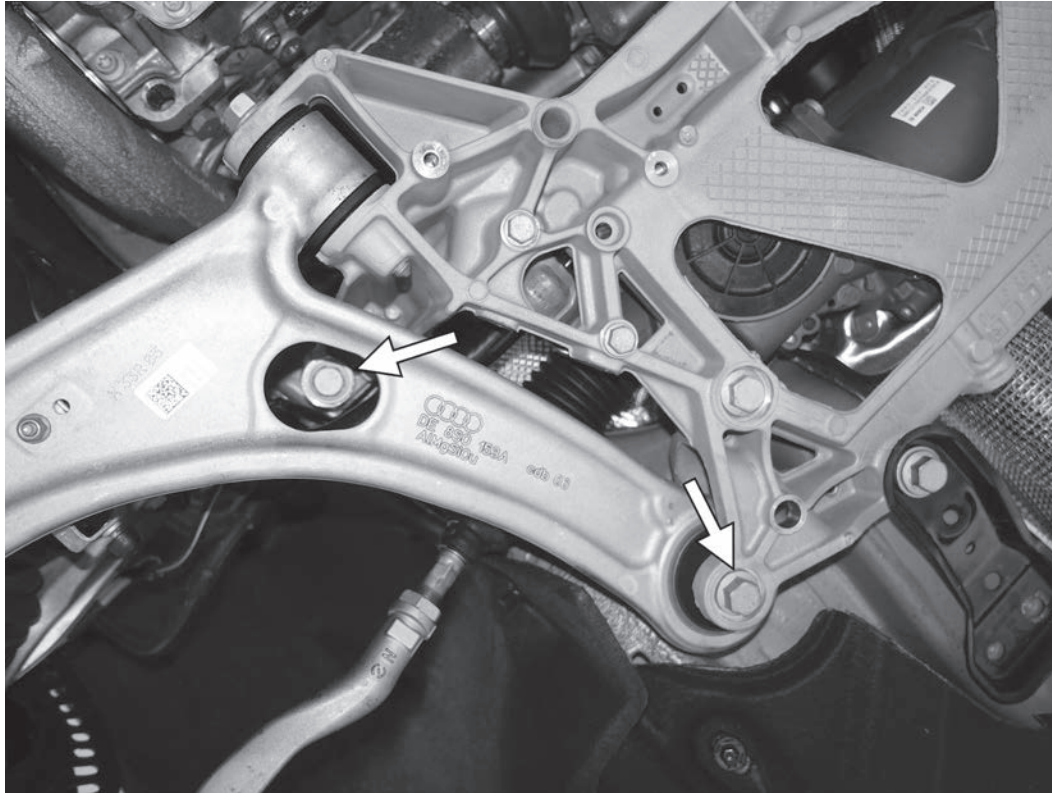

19) Remove the four 18mm screws (two shown in the picture) that hold the subframe to the chassis.



20) Lower the subframe of the car ~ 4" (100mm). Unclip the three clips (two shown) that hold the wiring harness to the steering rack and subframe.

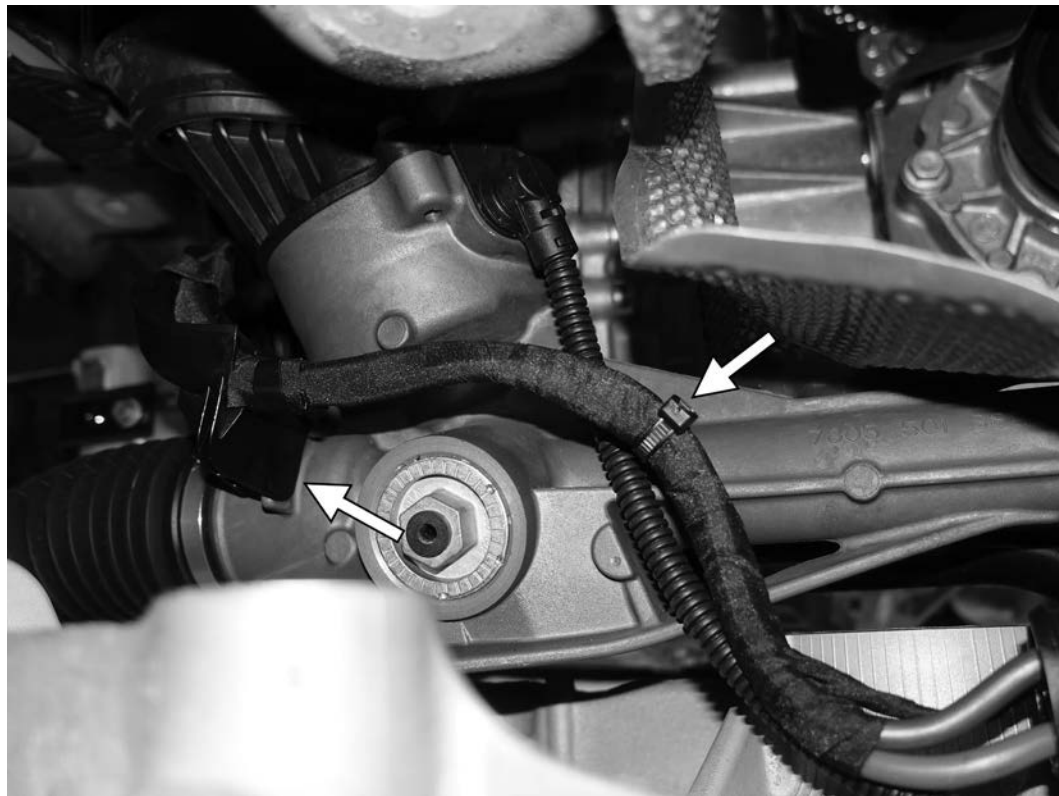

**TL100117**

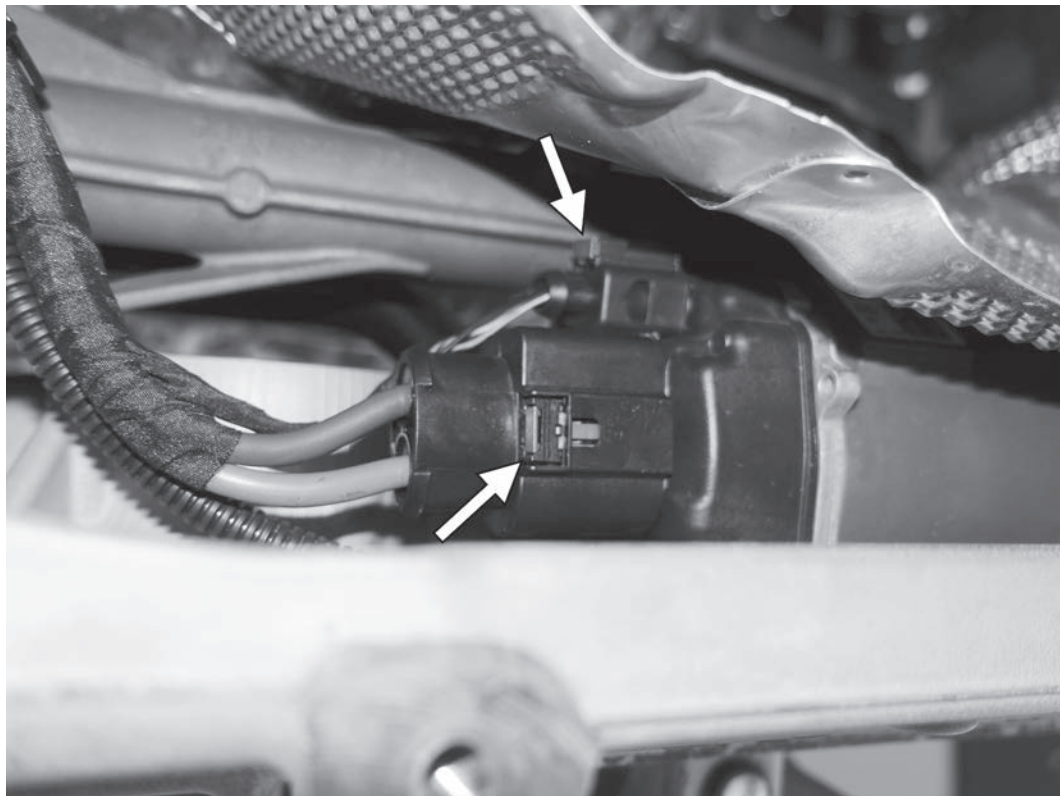

21) Slightly bend up the heat shield above the steering rack, and disconnect the two electrical connectors to the electric steering.

22) Carefully lower the subframe further, making sure everything is disconnected and that the wiring harnesses are free. Place the subframe aside where it will not be damaged.



**TL100117**

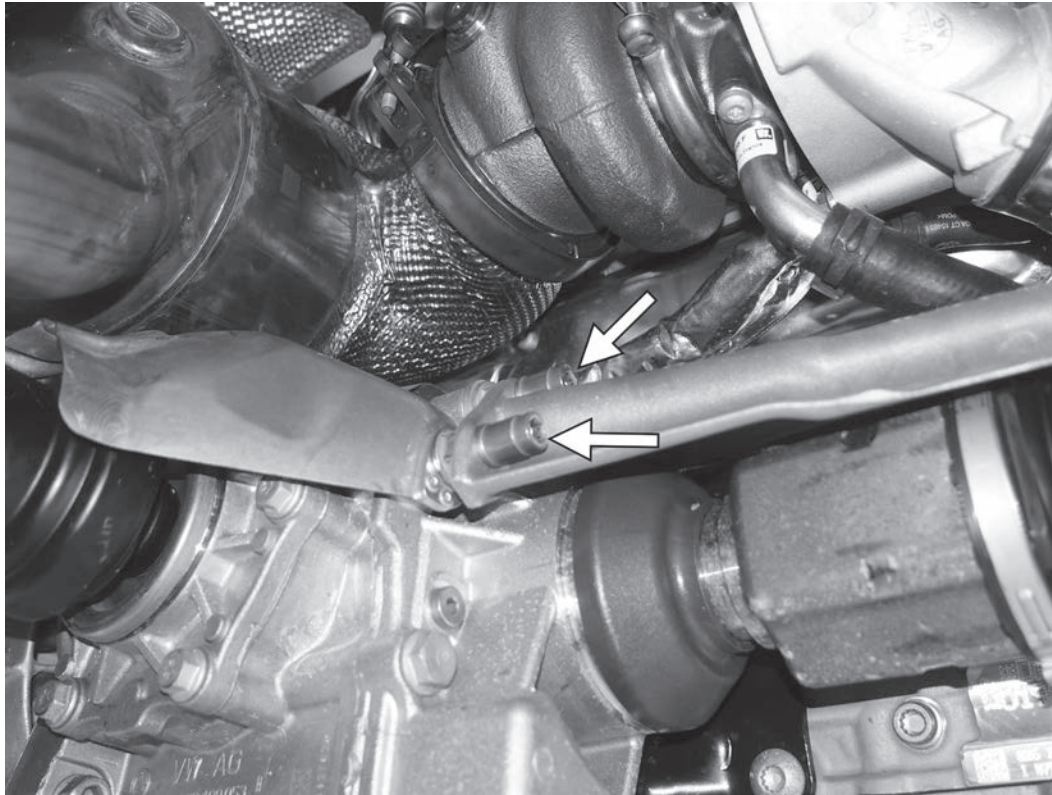

23) Remove the two 8mm allen screws from the heat shield over the right axle, and remove the heat shield from the car.

24) Begin to remove the differential heat shield by removing the lower 16mm screw the axle heat shield was mounted to. There is also a hidden 10mm triple square screw that is above and slightly forward of the axle. Remove this screw as well.

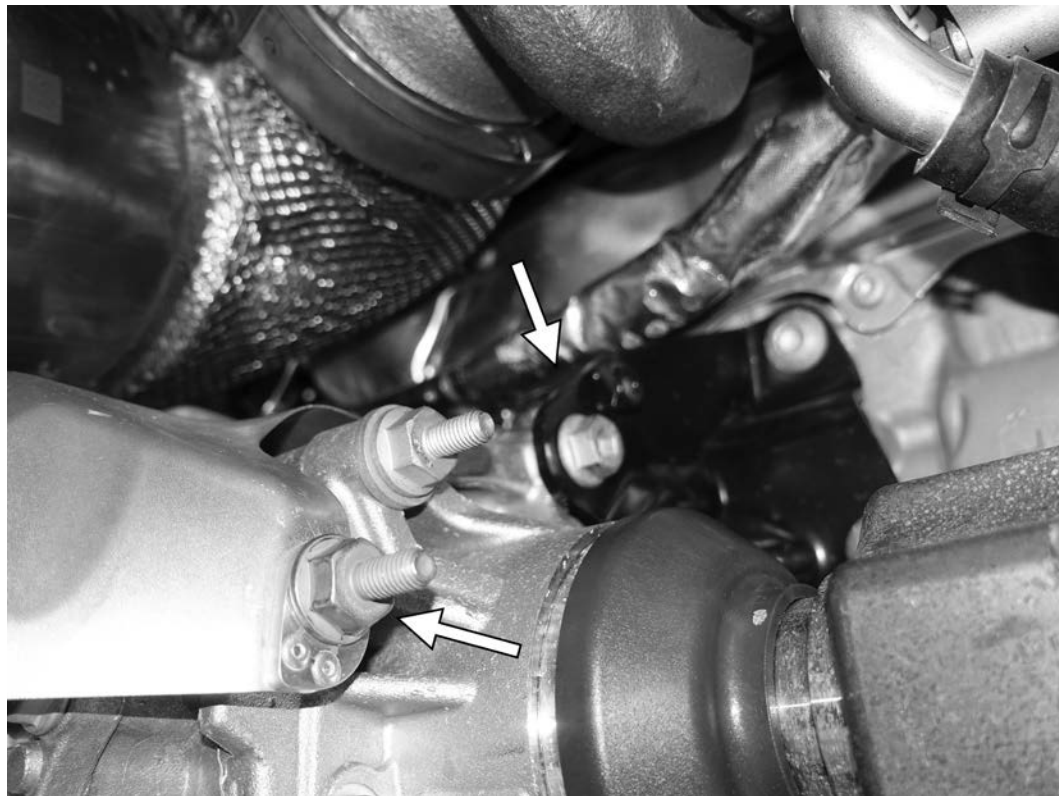



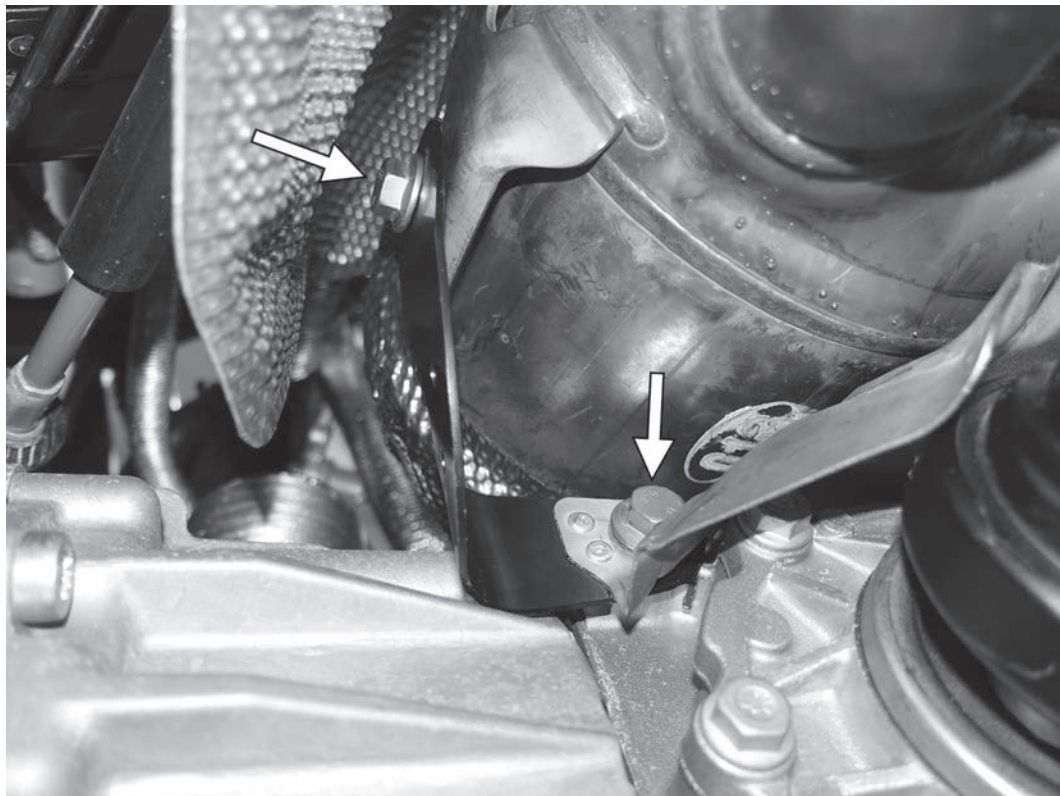

25) On the left side of the differential heat shield, remove the two 13mm screws on the axle heat shield. The differential heat should be loose now, but do not remove it from the car.

26) Carefully pry the driveshaft off the differential. Try to use even pressure on the lip of the driveshaft to separate it.



**TL100117**



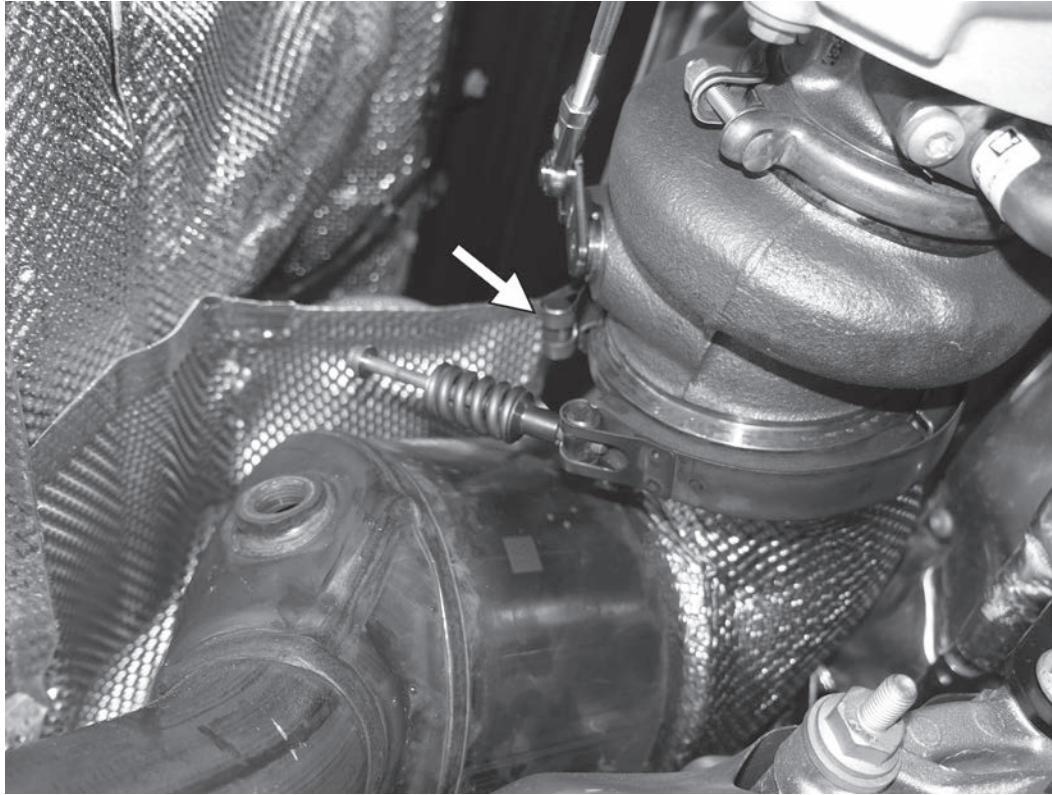

27) Separate the V-Band bolt from the upper side so that the downpipe is free from the clamp. A hammer may be needed to free the clamp from its mounting surfaces.

28) Have an assistant use a pry bar to rotate the lower portion of the engine/transmission forward while supporting the driveshaft. Fully separate the driveshaft from differential, and separate the downpipe from the turbocharger.



TL100117

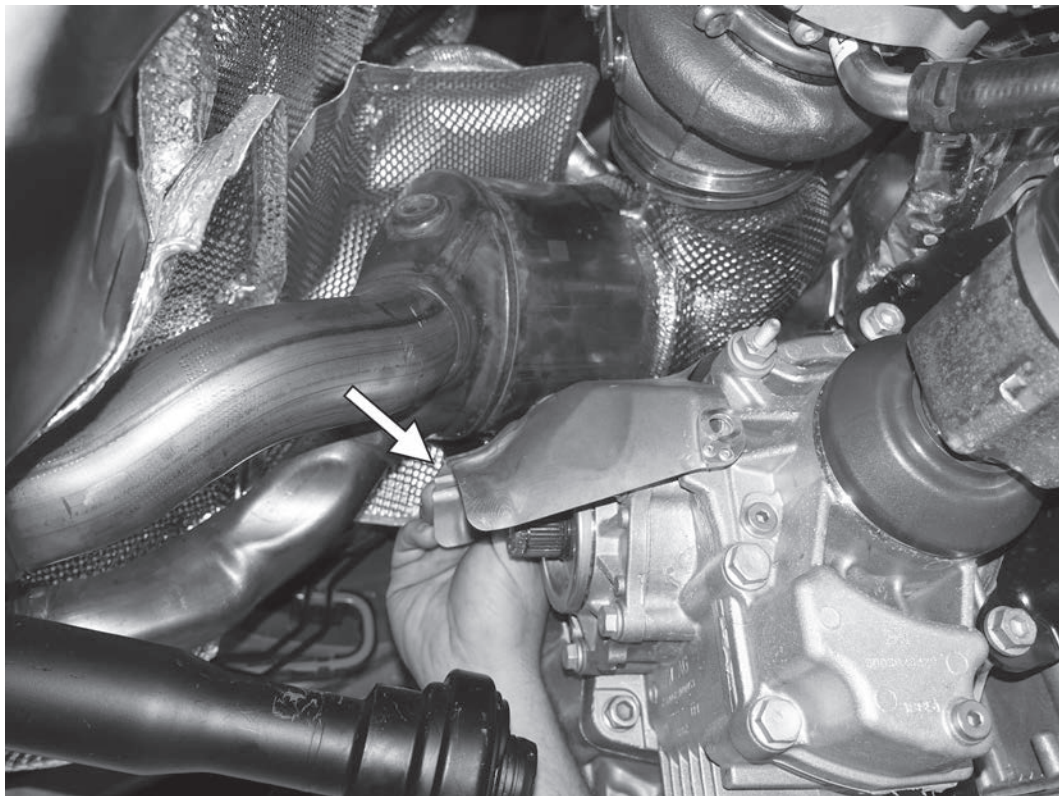

29) With the engine still moved forward, remove the differential heat shield from the car.

30) Lower the downpipe in the car. Once the downpipe cannot go down more due to the driveshaft, rotate the downpipe clockwise (as seen from the back of the car), and remove the stock downpipe from the car.



**TL100117**



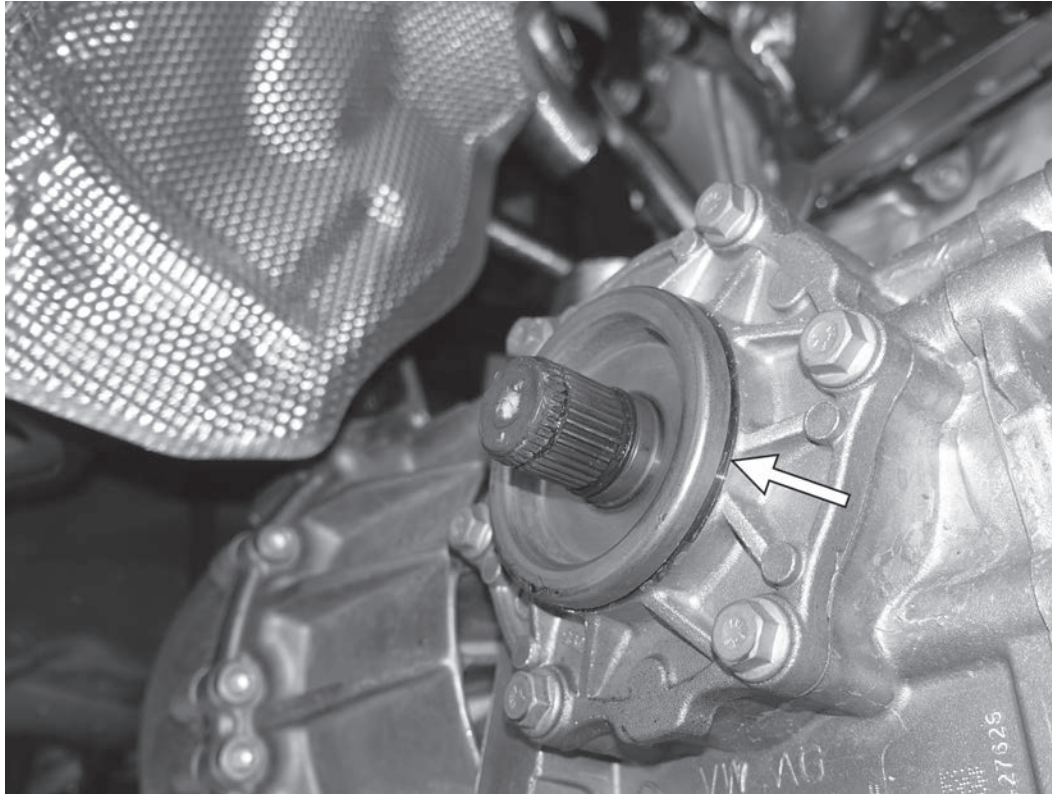

31) There is a metal seal ring around the output shaft of the center differential that may have become displaced from prying off the drive-shaft. Use a hammer to carefully tap the seal evenly back in place.

32) Install the APR downpipe to the turbocharger outlet. It may be necessary to move the V-Band clamp to get the flange of the APR downpipe seated correctly on the turbocharger.



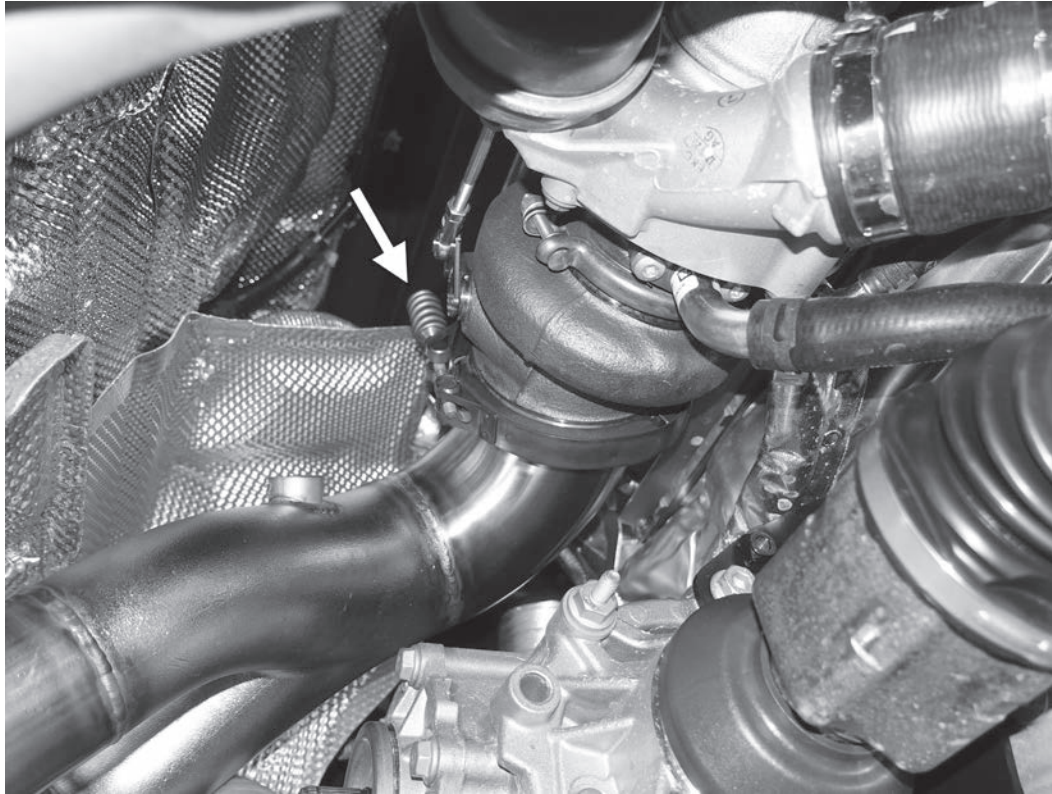

33) Install the factory V-Band clamp and connect the bolt from the lower side to the upper side.



34) Loosely reinstall the differential heat shield.



**TL100117**

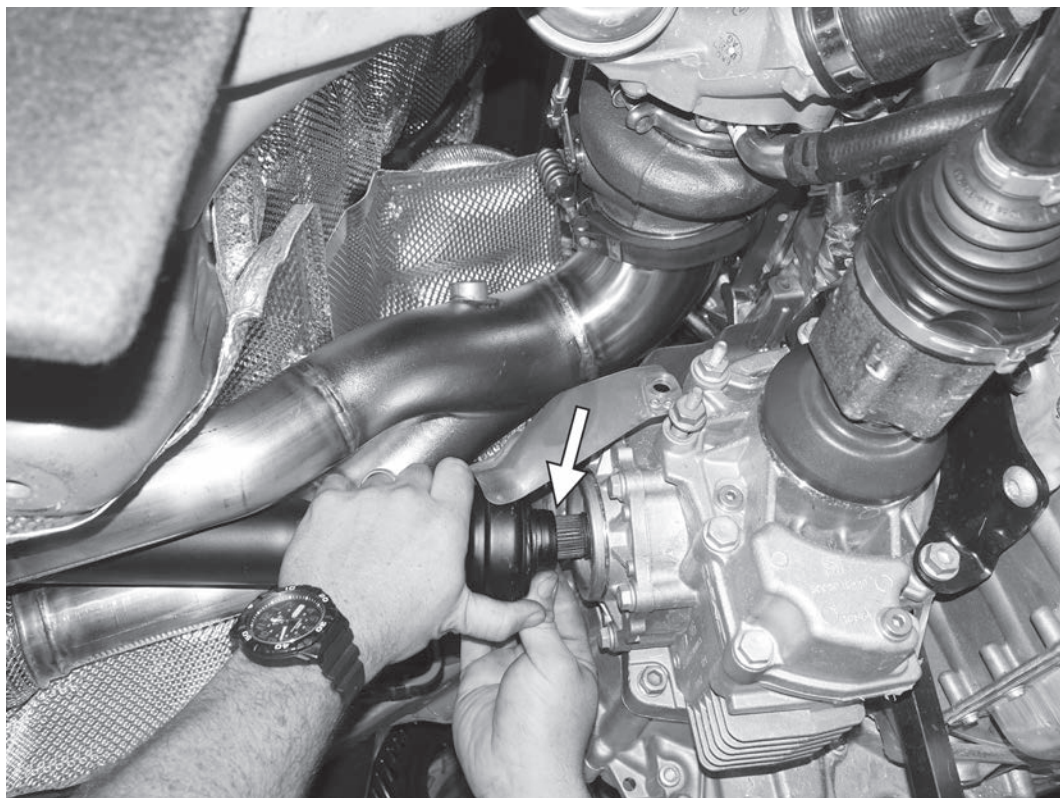

35) Respline the driveshaft to the differential output shaft. You will need to rock the engine forward with a pry bar to get this in place.

**APR**

36) Rock the engine back with the pry bar and fully seat the driveshaft on the differential output shaft.

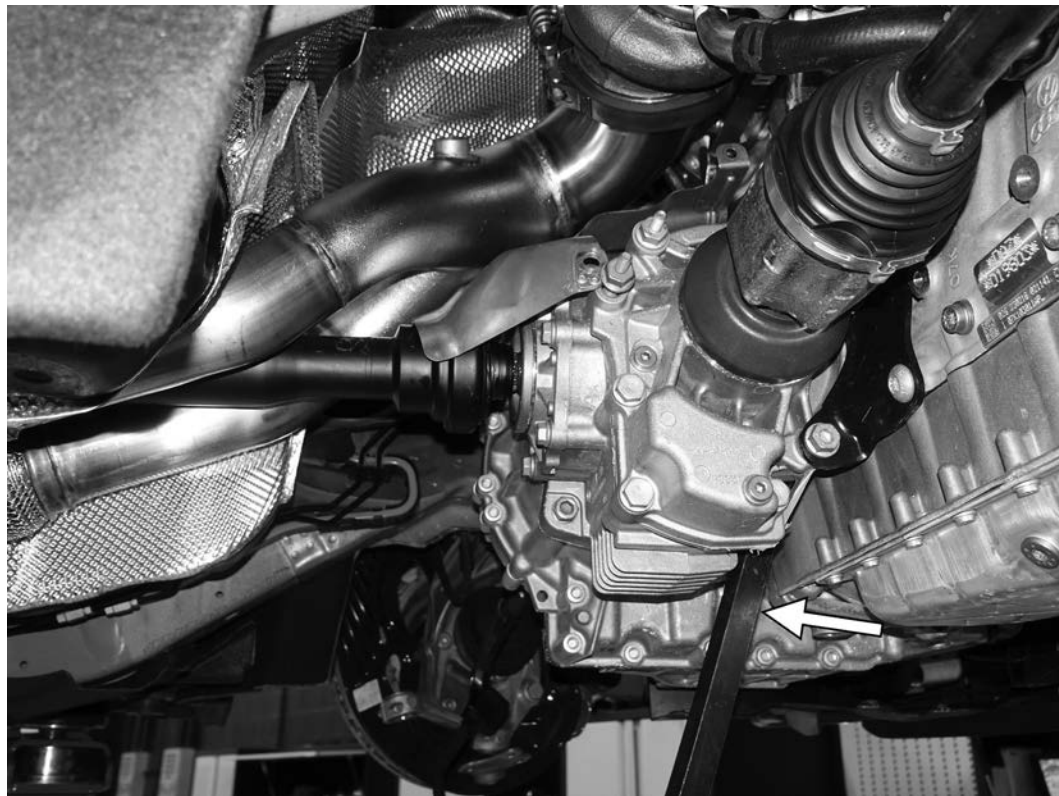

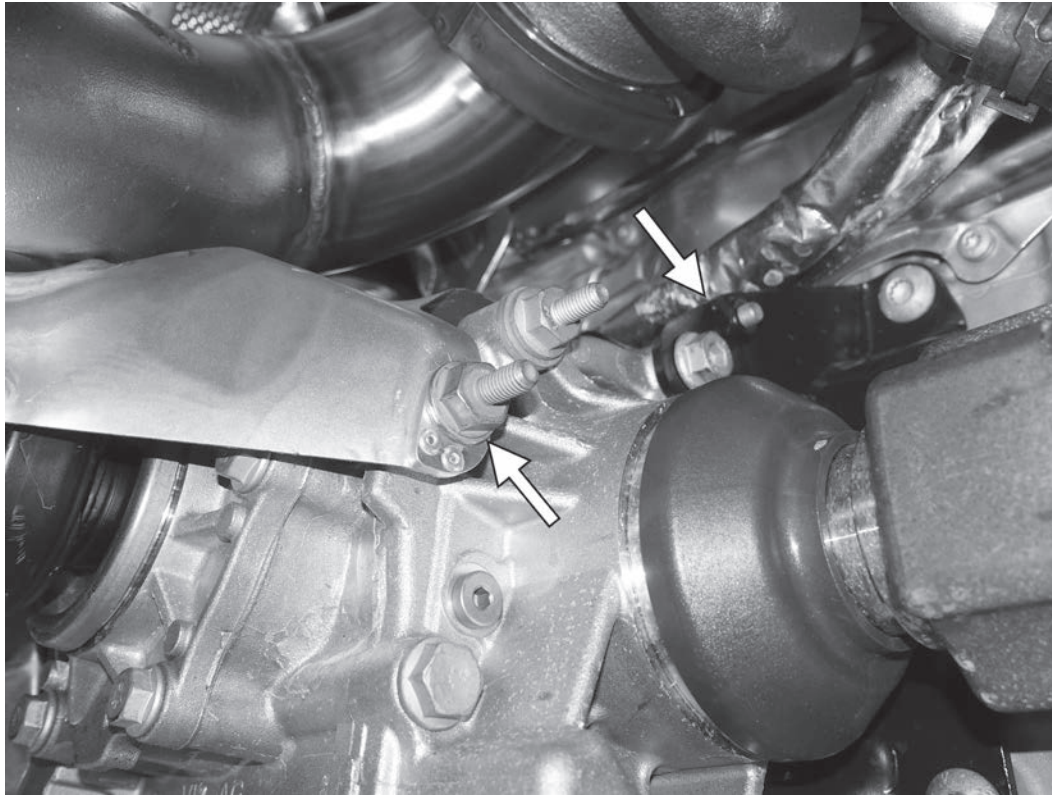

37) Fully reinstall the differential heat shield. On the right side of the heat shield, loosely install the 10mm hidden triple square above and in front of the axle. Loosely reinstall the 16mm screw that has the mounting stud for the axle heat shield.



38) Reinstall the lower 13mm screw on the left side of the heat shield. Torque this screw to 177 in-lb (20Nm). The upper 13mm will not be reinstalled. On the right side of the heat shield torque the 10mm hidden triple square screw to 177 in-lb (20Nm). Finally torque the 16mm screw to 30 ft-lb (40Nm).

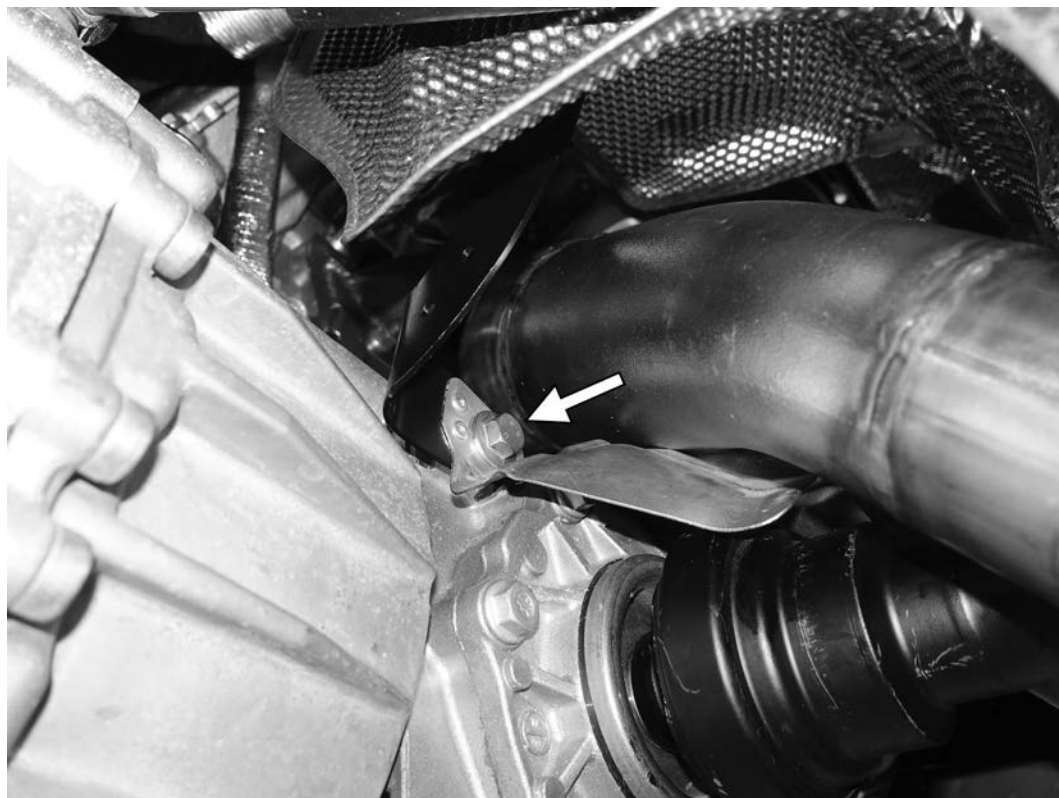



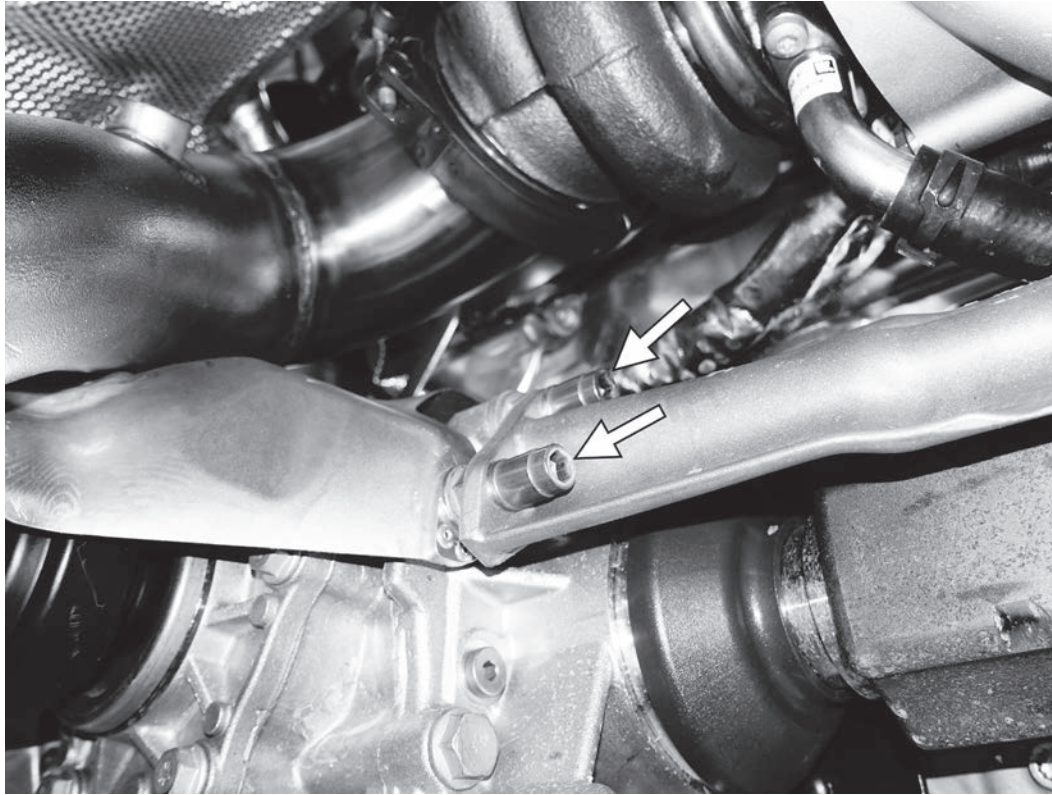

39) Reinstall the right axle heat shield with the two 8mm allen nuts. Torque the nuts to 18.5 ft-lb (25Nm)

40) Prepare the subframe for reinstallation on top of a transmission jack. Make sure the spacers between the subframe and the chassis are still on top of the subframe.

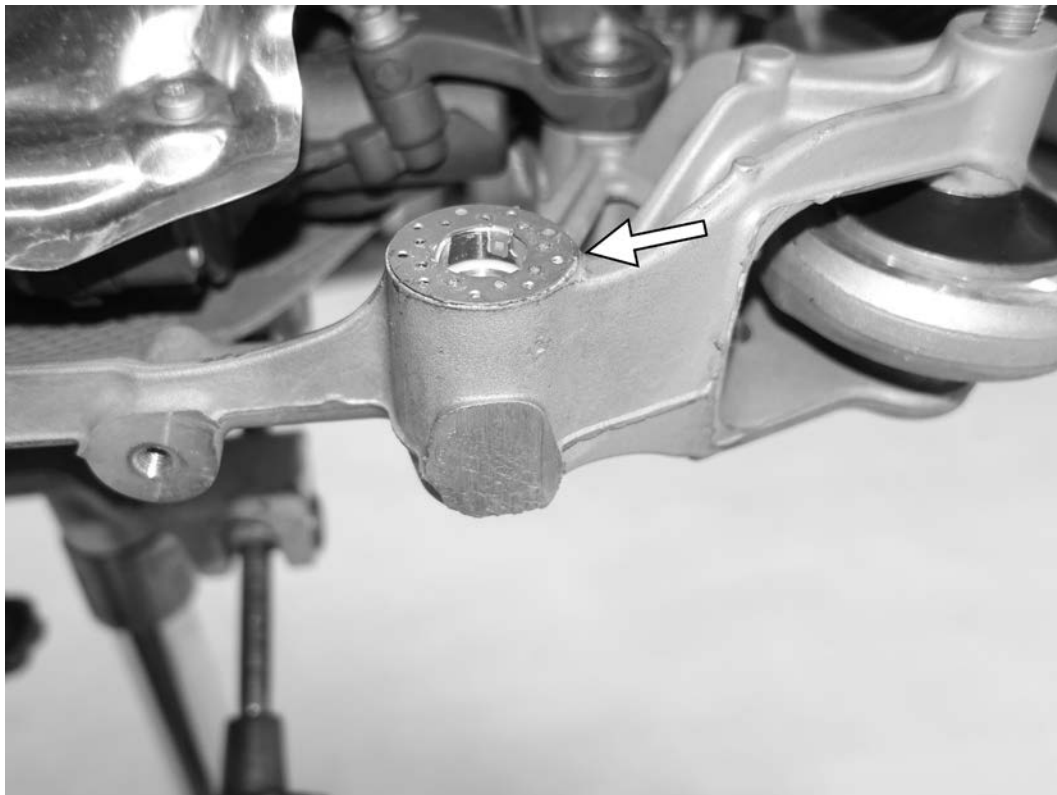

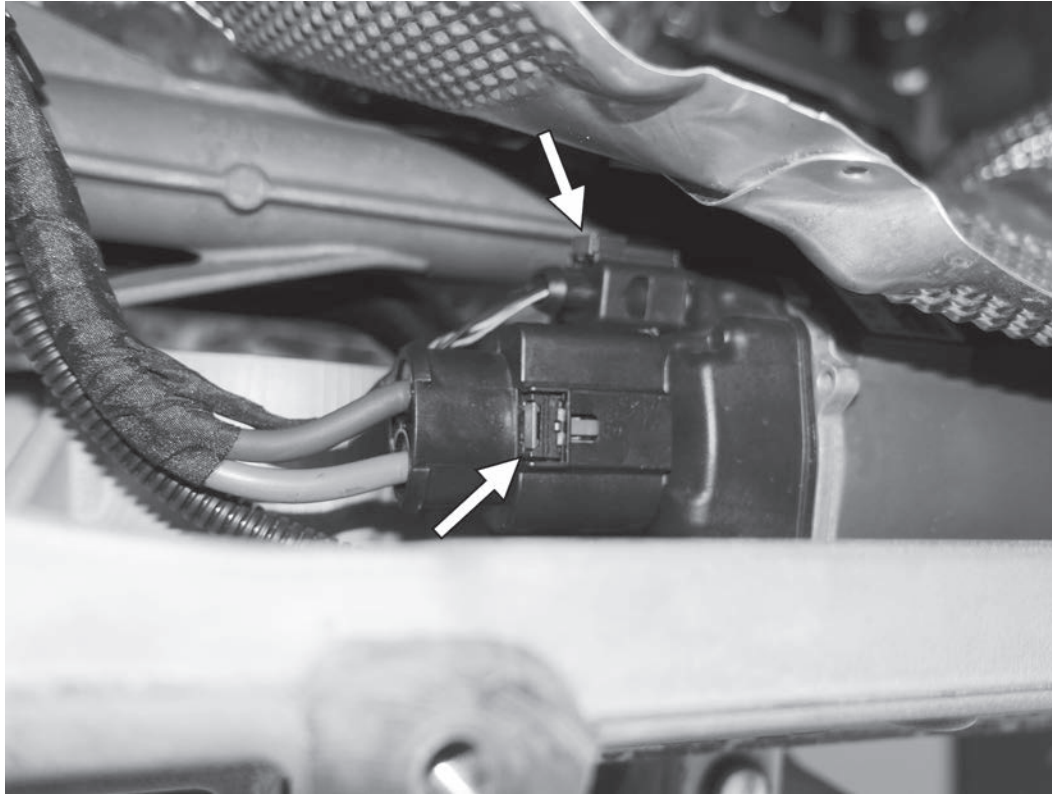

41) Raise the subframe until it is approximately 4" (100mm) from the car. Reroute the wiring harness for the steering rack, and reconnect the two electrical connectors on the steering rack.

42) Reclip the steering rack wiring harness to the subframe, as it was installed before. All three clips should be remounted to the steering rack or subframe.

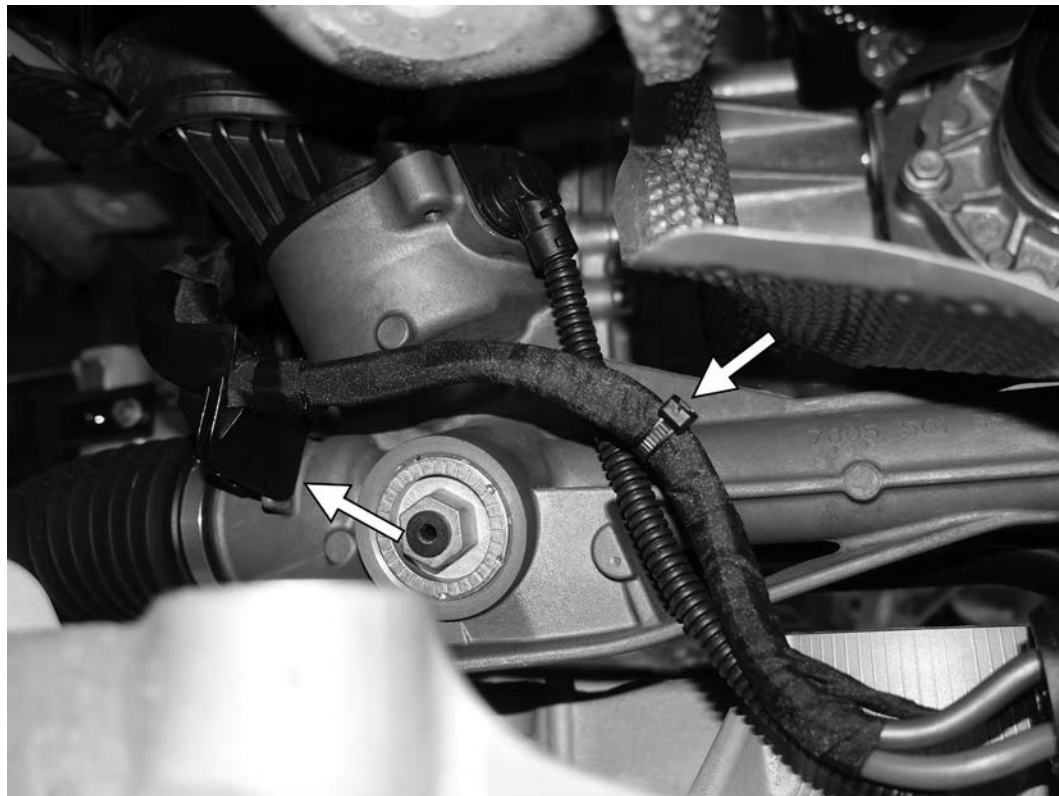

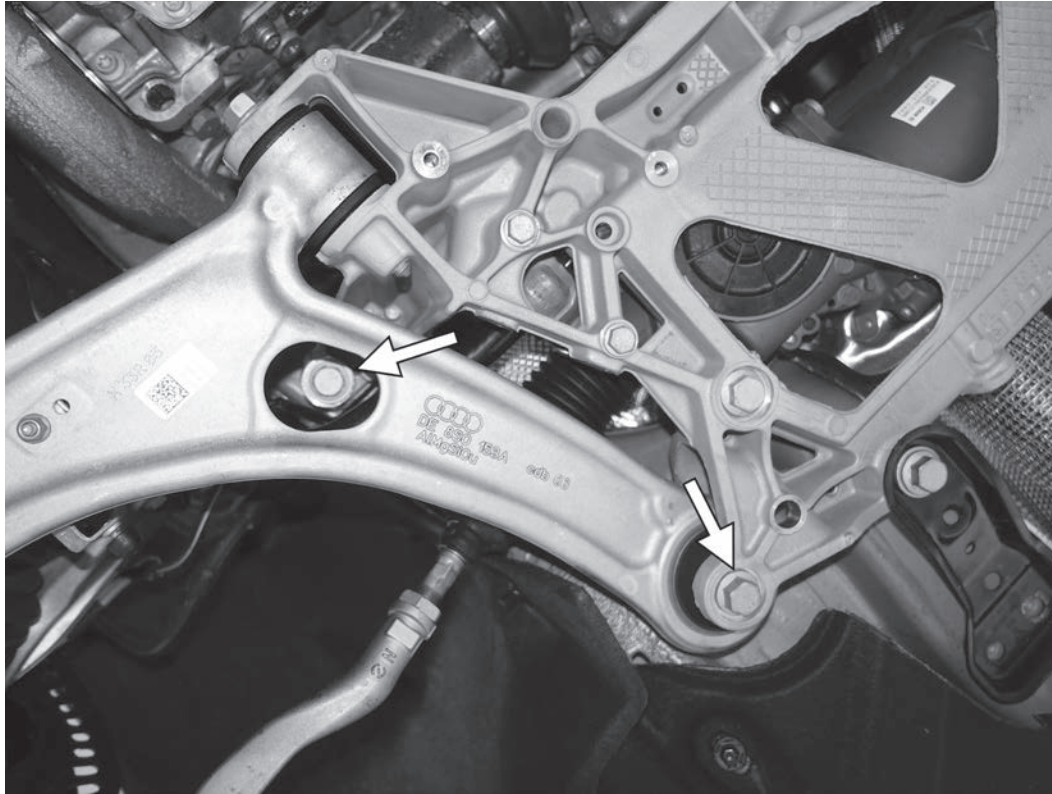

43) Raise the subframe further in the car. Loosely reinstall the four man mounting bolts. It is highly recommended to replace these bolts every time they are used. Once all four bolts are in, try to position the subframe back where it originally was located, and then torque all four bolts to 52 ft-lb (70Nm). Once torqued, tighten each bolt an additional 180°.



44) Reinstall the two 18mm bolts holding the lower engine mount to the transmission. You may have to use a pry bar to bring the engine to the correct location to install these bolts. It is highly recommended to replace these bolts every time they are used. Tighten these bolts to 37 ft-lbs (50Nm). Once torqued, tighten bolt each bolt an additional 90°.



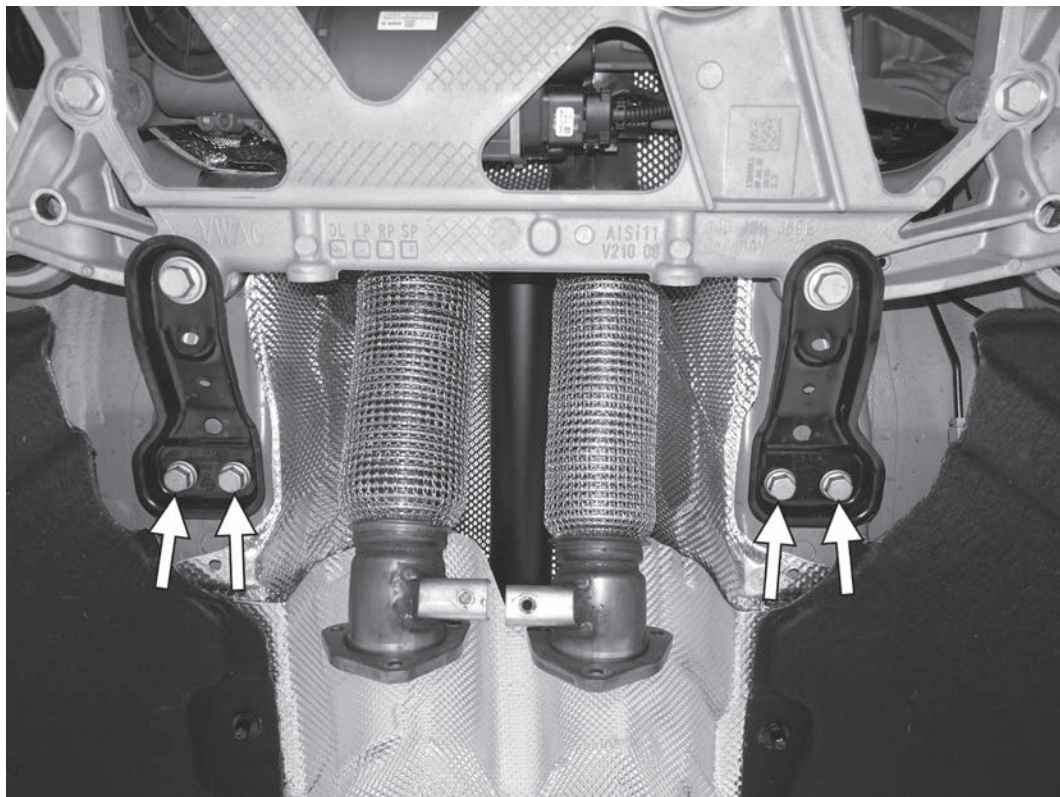

45) Reinstall the four 16mm screws holding the brackets on the back of the subframe to the chassis of the car. It is highly recommended to replace these bolts every time they are used. Torque these four bolts to 177 in-lbs (20Nm). Once torqued, tighten bolt each bolt an additional 90°.

46) Install the three 16mm nuts holding the lower balljoint brackets to the lower control arms on both sides of the car. Try to put these nuts back into their original location that you marked on the slots in the balljoint brackets. It is highly recommended to replace these nuts every time they are used. Torque these six nuts to 30 ft-lbs (40Nm). Once torqued, tighten bolt each nut an additional 45°. Install the two tie rod ends into the uprights and secure with the two 21mm nuts. It is highly recommended to replace these nuts every time they are used. Torque these our nuts to 177 in-lbs (20Nm). Once torqued, tighten bolt each nut an additional 90°.

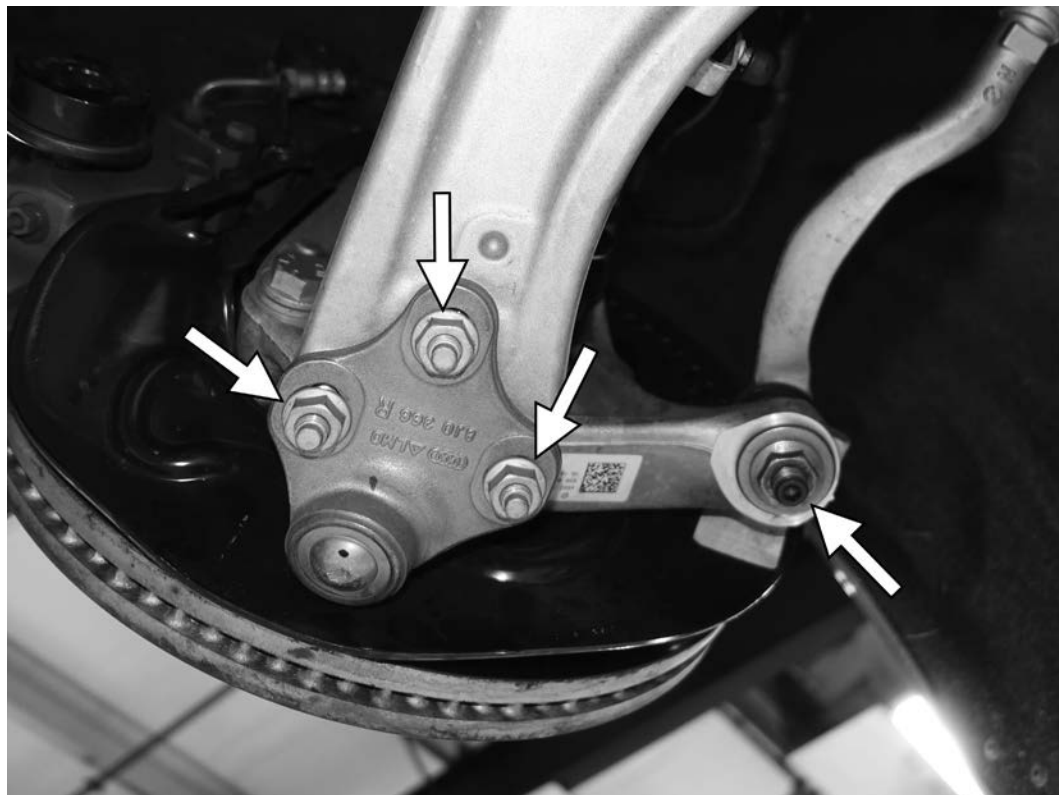

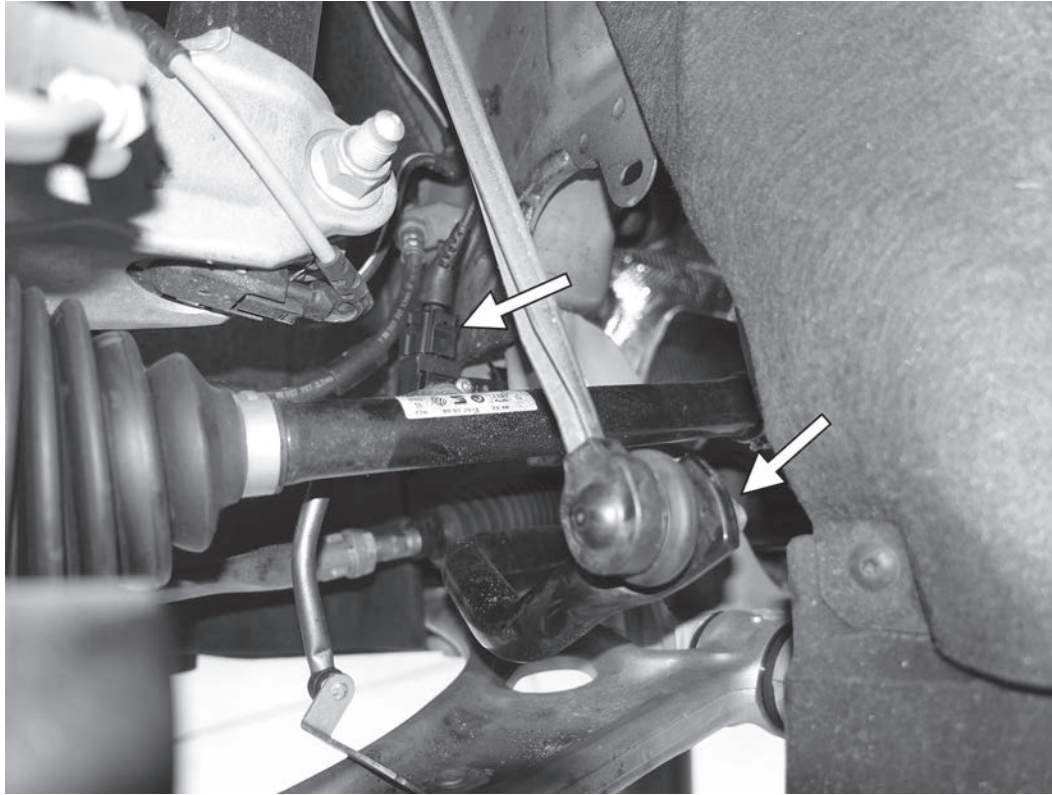

47) Install the 18mm nut holding the sway bar to the sway bar endlink. It is highly recommended to replace these nuts every time they are used. Counterholding the sway bar endlinks with a 4mm allen, torque this nut to 48 ft-lb (65Nm). Reconnect the electrical connector to the ride height sensor. Repeat on the other side of the car.

**APR**



48) Reinstall the factory exhaust mounting bracket. Install the two 13mm bolts holding the bracket to the subframe and torque to 17 ft-lb (23Nm). Install the two 10mm triple square screws and torque to 17 ft-lb (23Nm).

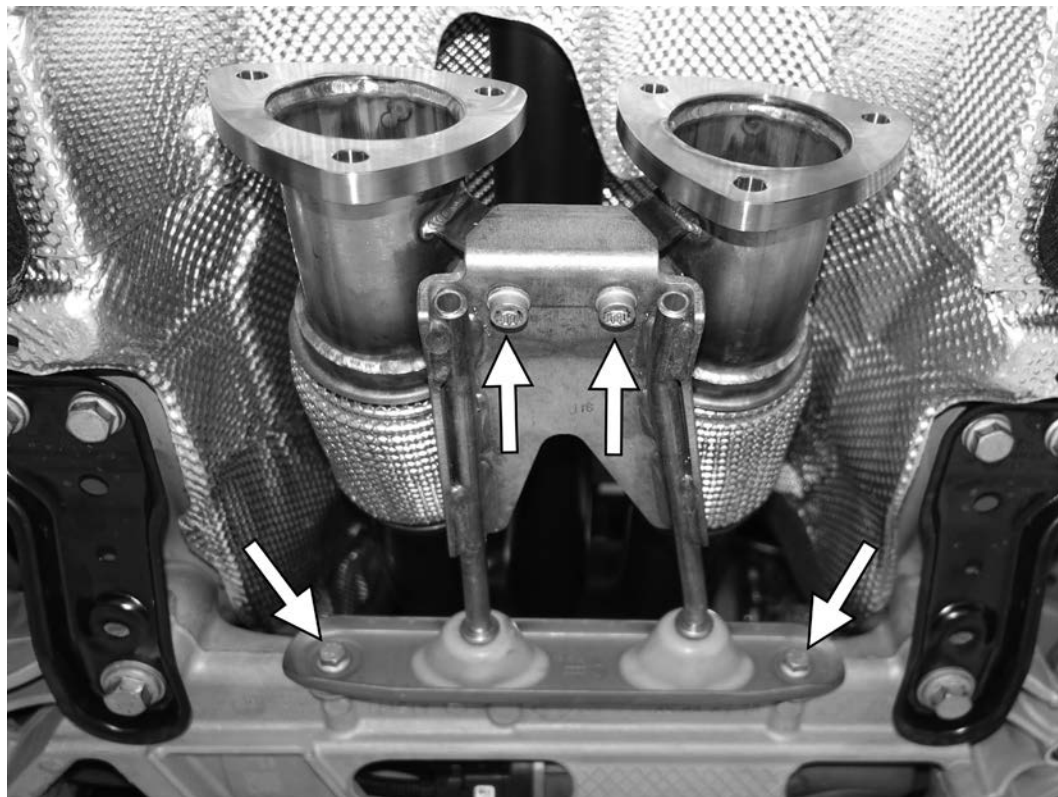

**TL100117**



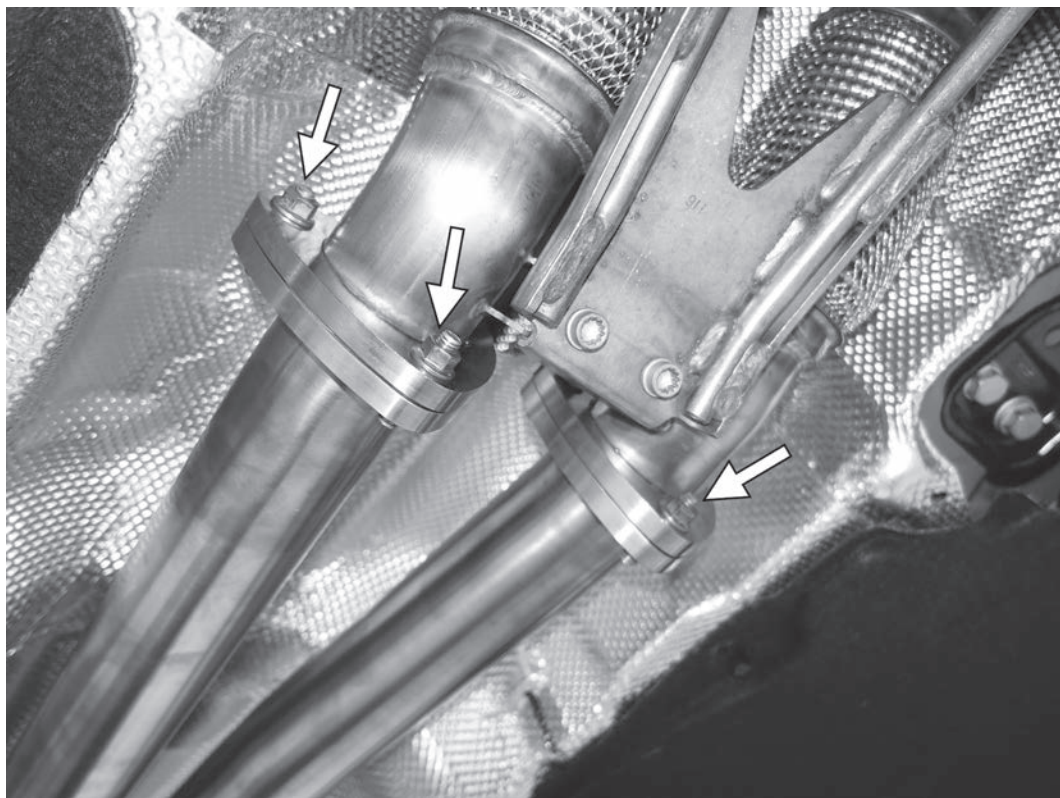

49) Install the midpipes onto the back of the downpipes with the gaskets. If installing stock midpipes, install with the factory 12mm nuts and torque to 17 ft-lb (23Nm). If installing APR midpipes, secure with the six supplied nuts and bolts. Torque the nuts to 17 ft-lb (23Nm).

***APR***

50) Connect the midpipes to the rear portion of the exhaust using the two factory sleeve clamps. Tighten the four 13mm nuts on the clamps evenly to 17 ft-lb (23Nm).

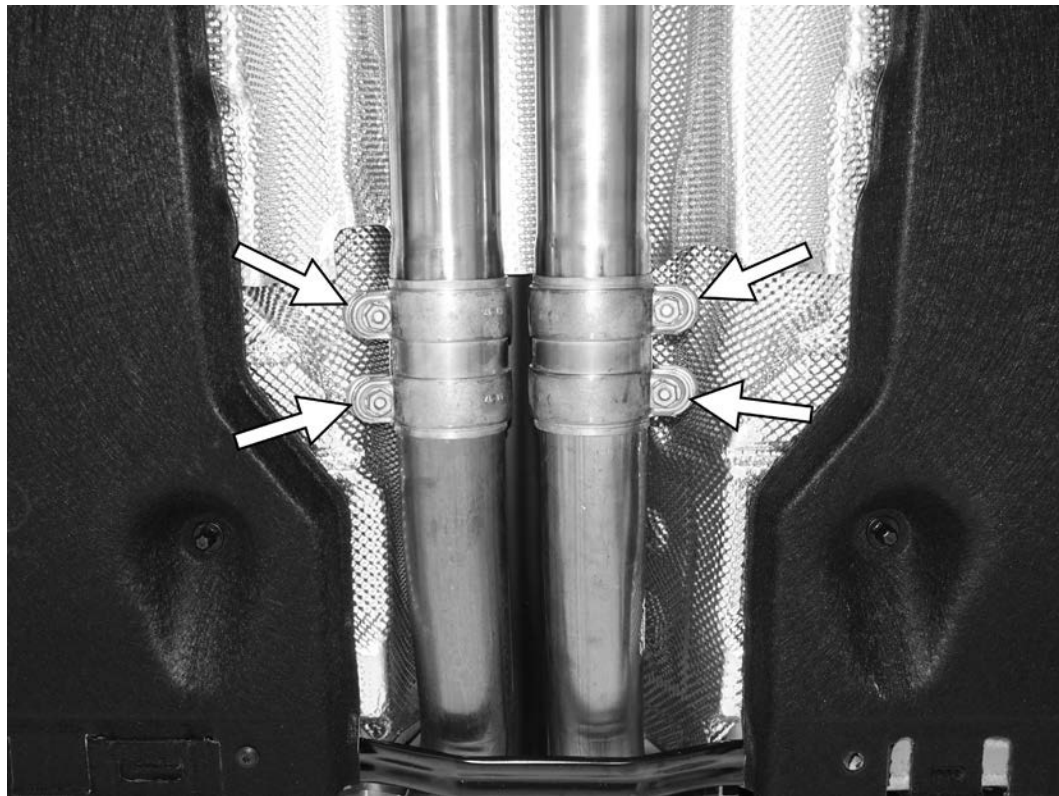

**TL100117**

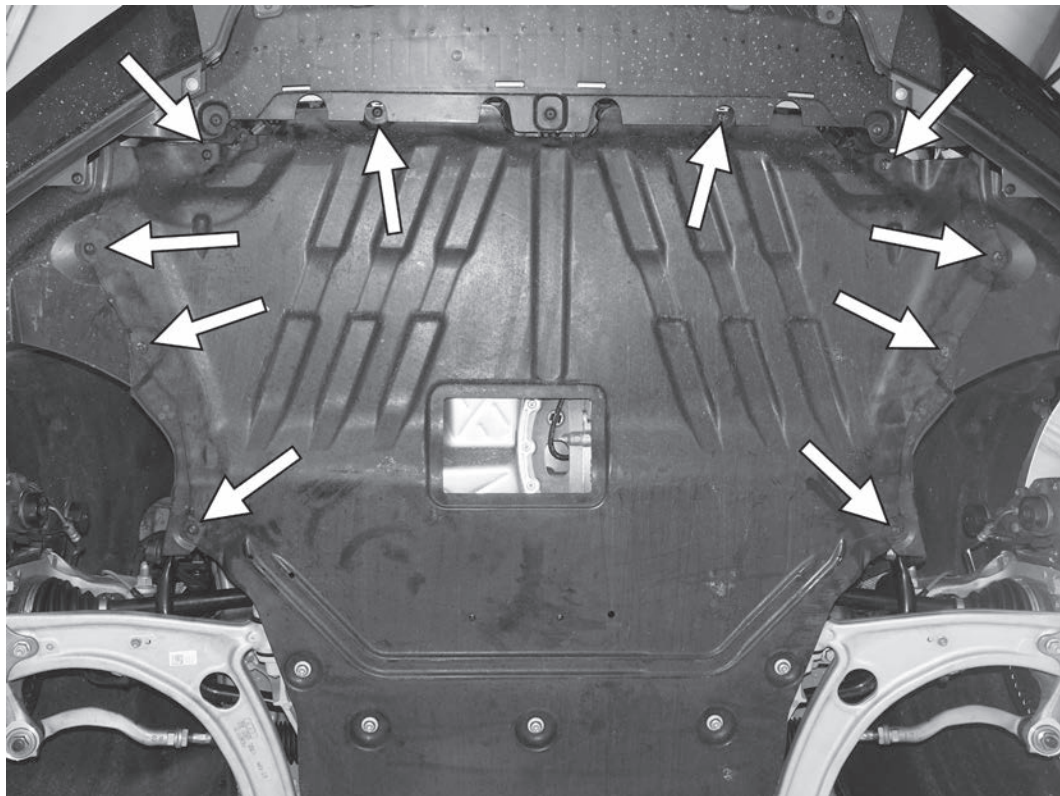

51) With an assistant, raise the belly pan back onto the car. Install the ten T25 screws on the front of the belly pan.

**APR**

52) Install the five T45 screws on the back of the belly pan, and then install the two push-pin style connectors on the back of the belly pan.

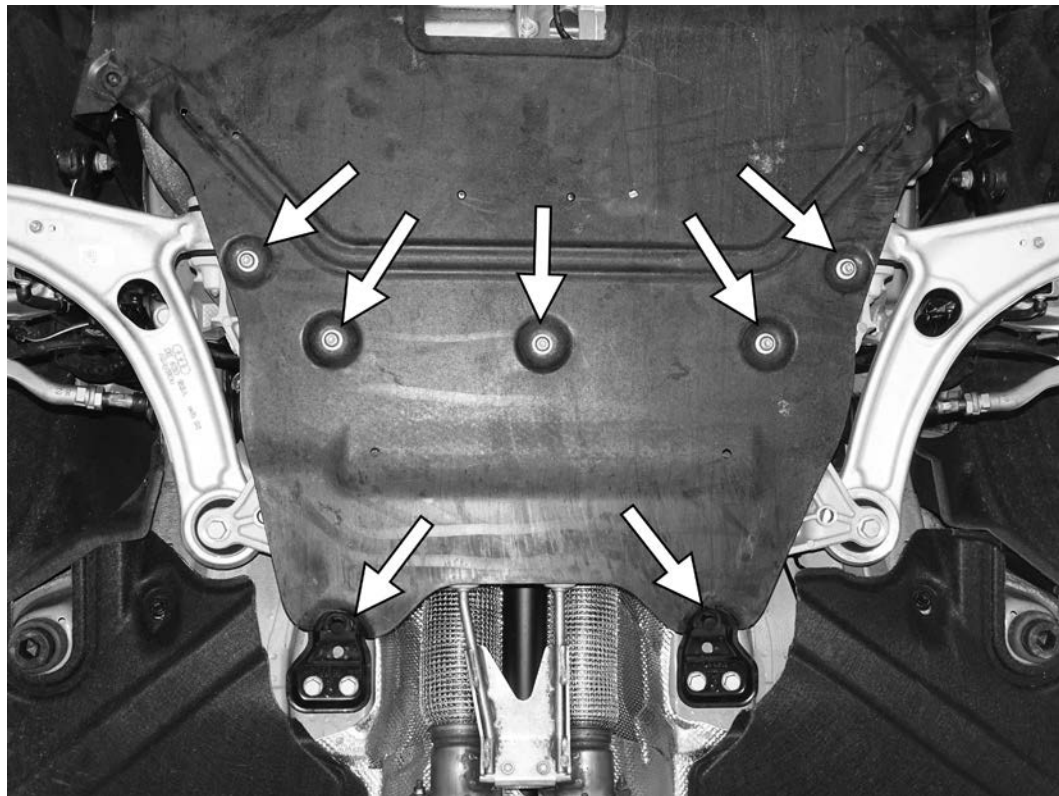

**TL100117**





53) Fully secure the V-Band clamp on the downpipe by torquing the T25 screw to 62 in-lb (7Nm).



54) Reinstall the primary oxygen sensor with the shorter wiring harness into the bung on the APR down-pipe closest to the turbocharger. Torque the sensor with an oxygen sensor socket to 41 ft-lb (55Nm).

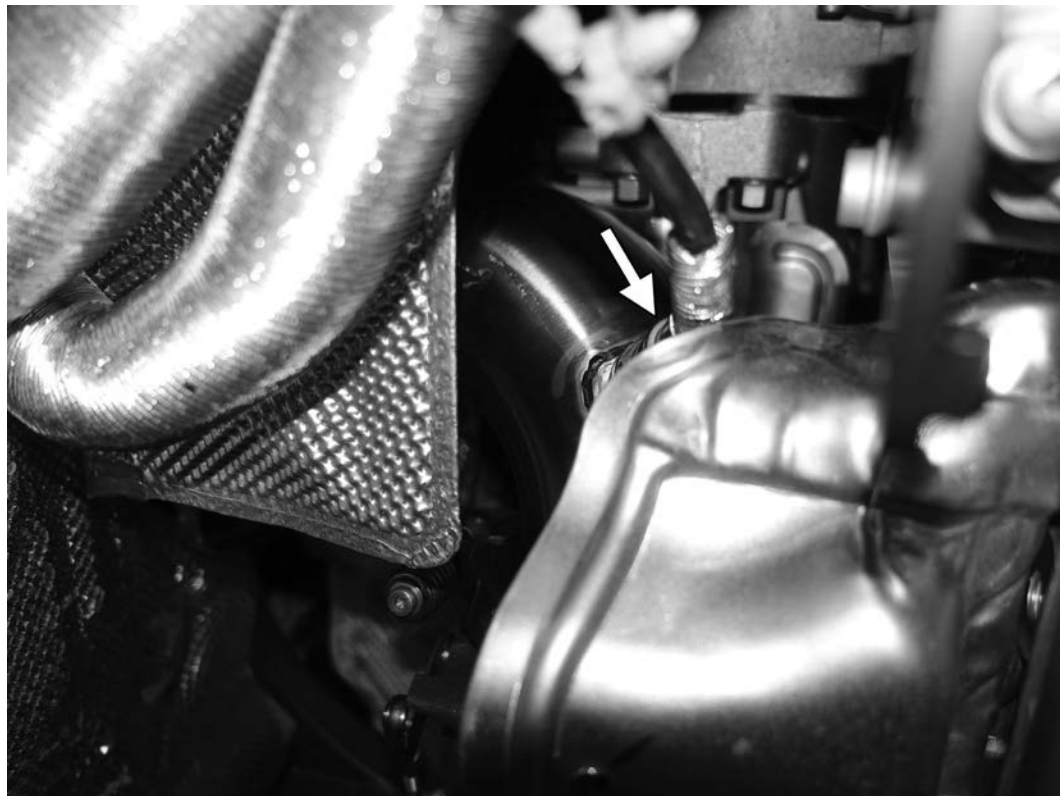

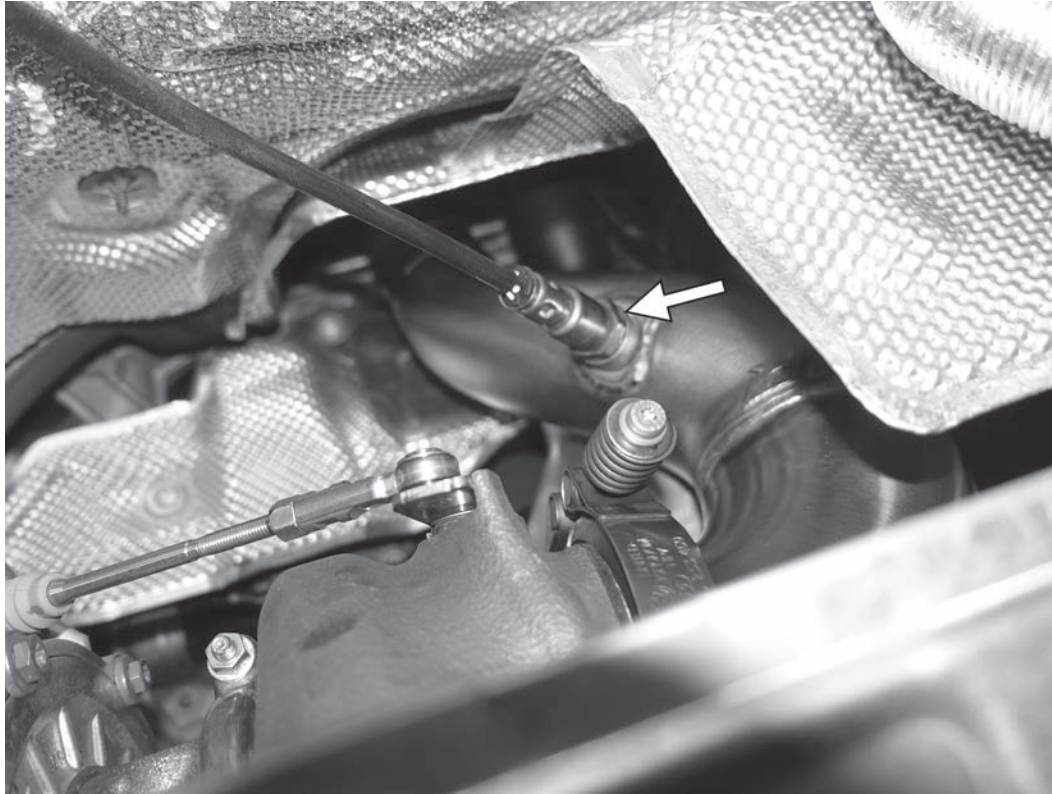

55) Reinstall the secondary oxygen sensor with the longer wiring harness into the bung on the APR down-pipe furthest from the turbocharger. Torque the sensor with an oxygen sensor socket to 41 ft-lb (55Nm).

**APR**

56) Reinstall and route both harnesses from the oxygen sensors back the way they were from the factory. Install the harness from the secondary sensor through the bracket lower on the firewall. Secure the harness to the clips still in the car with cable ties, reusing the factory clips. Reconnect both harnesses to the factory wiring harness, and reclip back on the mounting bracket on the firewall.

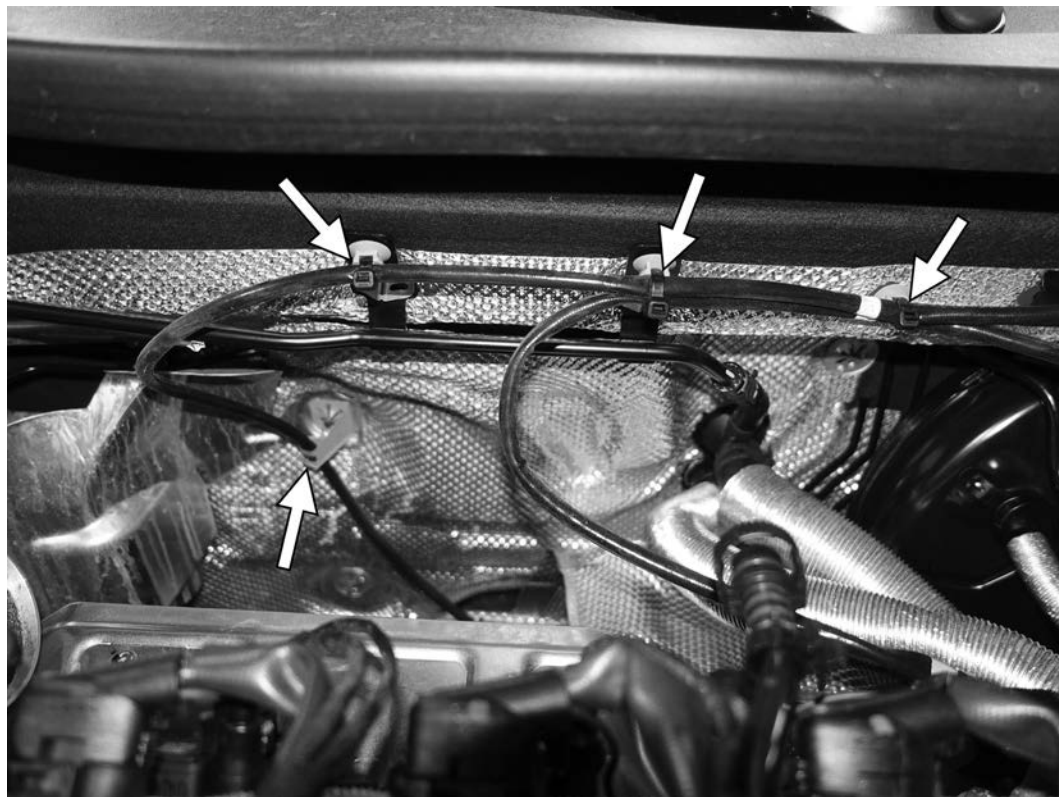

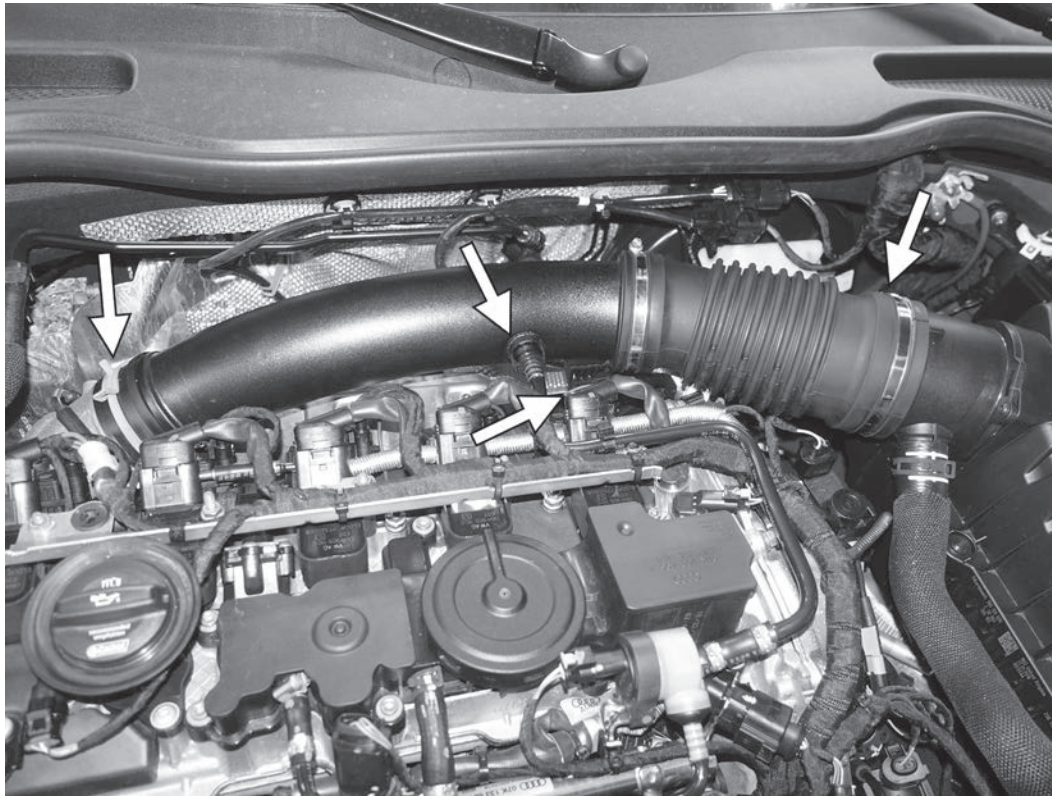

57) Install the stock intake tube between the accordian hose and the airbox. Install the T30 screw holding the tube to the cylinder head and torque to 80 in-lb (9Nm). Reconnect the Norma style fitting from the crankcase solenoid valve (N546). Install the spring clamp from the intake to the stock compressor inlet pipe. Finally, install the screw clamp holding the intake to the airbox and torque the clamp to 48 in-lbs (5.5Nm). Reinstall the engine cover.



58) Reinstall the steering column to the steering shaft, and install the 13mm bolt. It is highly recommended to replace these bolts every time they are used. Torque the bolt to 177 in-lbs (20Nm). Once torqued, tighten bolt each bolt an additional 90°. Replace the carpet and reinstall the two 10mm nuts holding the carpet down.







#TL100117

***GO APR.COM***