

Detroit Speed
Mustang Mini-Tub Kit
 1964.5-70 Mustang
 P/N: 040405DS

The Detroit Speed Mini-Tubs are inner wheel housings designed to accommodate wider wheel and tire package for the 1964½ - 1970 Mustang. They are designed for a precise fit, retain a stock appearance, and are available exclusively through Detroit Speed. The Mustang Mini-Tubs come with a replacement frame rail section and doubler reinforcement plates to accommodate a wider rear tire. The Mini-Tubs are up to 2-1/2" wider than stock, stamped from 18-gauge steel and proudly **Made in the U.S.A.**



Item	Component	Quantity
1	Detroit Speed Mini-Tubs - Mustang	2
2	Frame Rail Section, LH	1
3	Frame Rail Section, RH	1
4	90° Doubler Plate	2
5	Bottom Frame Rail Doubler Plate	2
6	Inside Frame Rail Doubler Plate	2
7	Floor Pan Cut Template	1
8	Instructions	1

INTRODUCTION

Congratulations on your purchase of the Detroit Speed Mustang Rear Mini-Tub Kit. Please read the entire set of instructions and fully understand all the steps involved before beginning the project. If you have any questions before, during, or after the installation, feel free to contact us by phone at (704) 662-3272 or by email at tech@detroitsspeed.com.

Wheel & Tire Fitment	Wheel Size	Tire Size
1964.5 - 1966 Mustang	17" x 11"	315/35R17
1964.5 - 1966 Mustang	18" x 11"	315/30R18
1967 - 1970 Mustang	17" x 12"	335/35R17
1967 - 1970 Mustang	18" x 12"	335/30R18

NOTES:

1. All work should be performed by a qualified welder and technician.
2. The DSE Mini-Tubs were designed to OEM sheet metal, therefore any aftermarket restoration sheet metal may require additional body work to fit to the DSE Mini-Tubs.
3. There is an installation video available through the Detroit Speed website under install video shown here: detroitsspeed.com/blog/post/detroit_speed_1964_5-70_mustang_mini-tub_install.
4. The factory fuel tank will not work with the Detroit Speed Mini-Tub Kit. Detroit Speed does offer a Mini-Tub Kit fuel tank for a carbureted or fuel injected engine with multiple fuel pump options for the 1964.5-1970 Mustang application (P/N 080124).
5. The rear valence on a 1965-66 Mustang GT will not work with the Detroit Speed Mini-Tub Kit.

I. PREPARING THE VEHICLE

1. Raise the vehicle a few feet off the ground so the interior, trunk, and the underside of the vehicle are accessible. Ensure the vehicle is level and well supported.
2. Disconnect the battery cables.
3. Remove the gas tank and fuel lines. **NOTE:** Make sure to eliminate all the fuel vapors from the work area before continuing.
4. Remove the rear suspension and axle.
5. Remove the seats, carpet, carpet padding, rear interior quarter trim panels, and package tray. Any other interior panels, headliner, door panels, etc., should be removed or masked well to protect them from grinding and welding sparks.

6. Remove the trunk lid, springs, and hinges. Take care when removing the trunk springs as they are under high tension when installed.

II. REMOVE THE STOCK INNER TUBS

1. Cut out the lower and upper seat brackets from the vehicle (Figure 1). These brackets will be re-installed into the vehicle later.



Figure 1 – Remove Lower & Upper Seat Brackets

2. Cut the back of the interior panel bracket away from the floor pan and move it out of the way (Figure 2). It will be re-attached later once the Detroit Speed mini-tubs are installed.



Figure 2 – Remove Interior Brackets

3. Go to Step 4 if you have a coupe, follow this step if you have a Fastback. Mark a horizontal line on the rear seat corner support above the stock inner tub and cut along this line. From underneath the stock tub, cut around the flange of the rear seat support that attaches to the stock inner tub. Remove this piece from the vehicle and save for re-installation later (Figure 3 on the next page). Continue to Step 5.

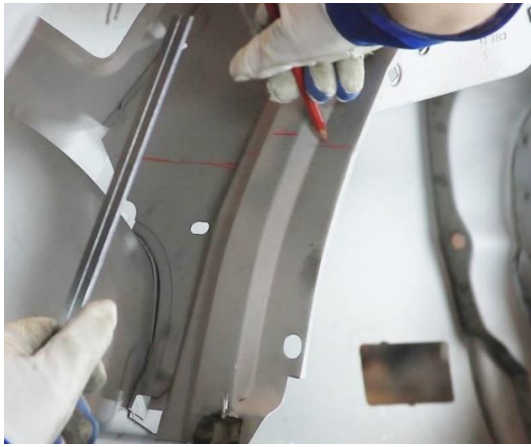

Figure 3a - Remove Seat Support (1970 Fastback)



Figure 3b - Remove Seat Support (1965 Fastback)

4. Drill the spot welds out of the upper decklid hinge mounting flange and separate. Cut the lower decklid hinge bracket out of the stock tub and remove the hinge assembly from the car. Remove the rear seat corner support completely from the car. First drill out spot welds in the upper areas of the bracket and separate from the body structure. Cut the remaining section out of the stock tub and remove the bracket from the car. After the bracket is removed from the car, grind spot welds and remove the stock tub material from the flanged area. Straighten and grind the part smooth for re-use later. (Figure 4).

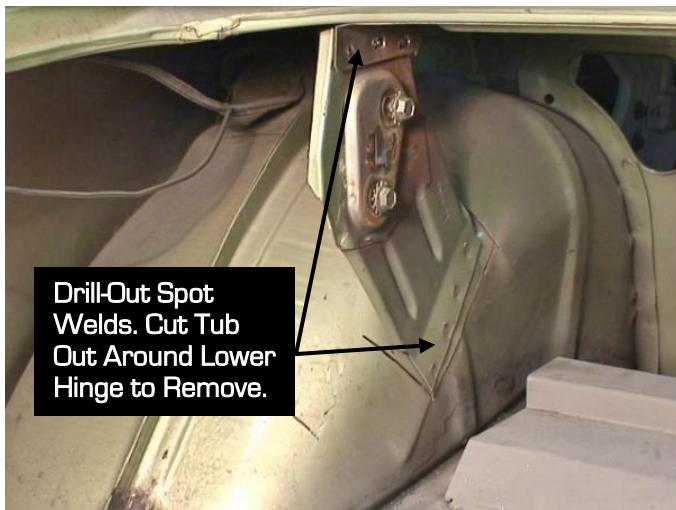

Figure 4 - Remove Seat Support & Decklid Hinge (Coupe)

5. Cut out the provided mini-tub floor pan cut template and place it up against the stock inner tub. Trace along the inside of the template as this will be your cut line for the Detroit Speed mini-tub. From underneath the stock inner tub, draw a cut line to the inside of the stepped seam between the inner and outer stock tub (Figure 5).



Figure 5 - Trace Floor Pan Cut Template

6. Cut along this line around the top of the stock inner tub and then cut along bottom of the inner tub above the trunk floor (Figure 6). Connect your cut line and remove the stock inner tub from the vehicle.



Figure 6 - Cut Out & Remove Inner Tub

7. Make a vertical cut line on the inner tub flange behind and in front of the rear axle bump stop bracket that's welded to the outer frame rail. Cut away the flange section of the trunk floor pan above the bump stop bracket (Figure 7).

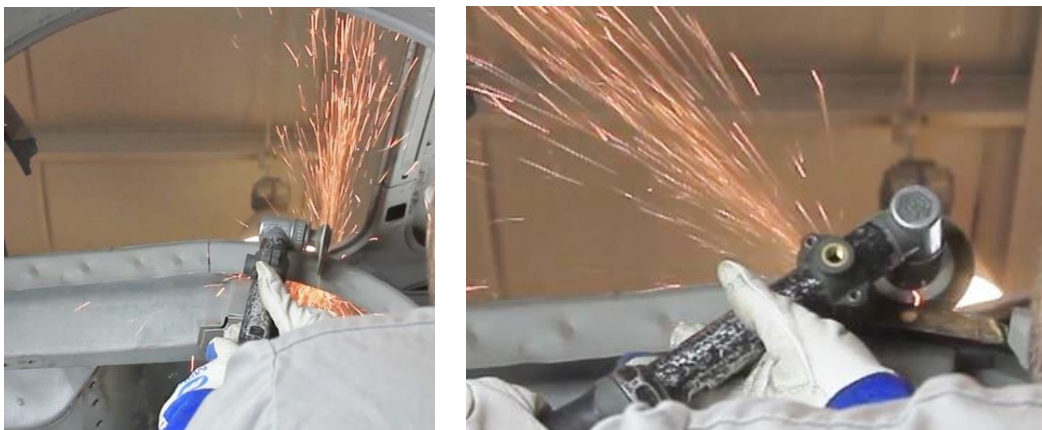

Figure 7 - Remove Flange above Bump Stop Bracket

8. Drill out the spot welds holding the bump stop bracket to the outer frame rail and remove the bracket (Figure 8).

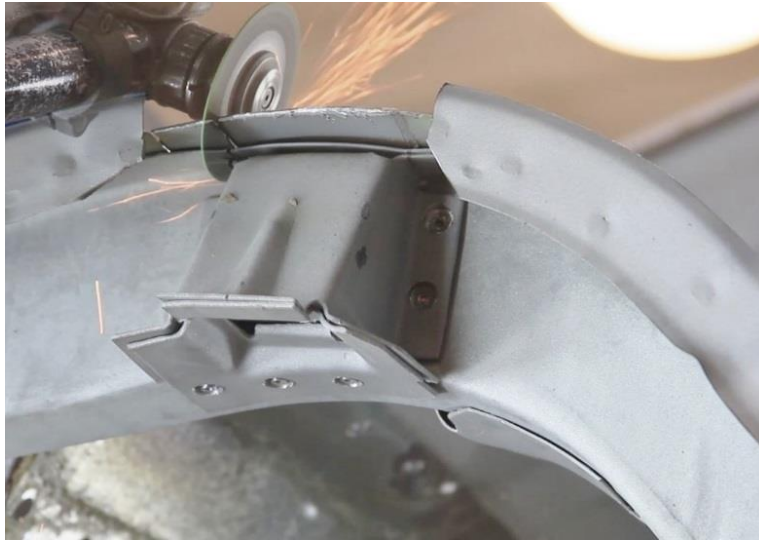

Figure 8 – Remove Bump Stop Bracket

9. Cut the inside trunk floor pan where you traced the mini-tub floor pan cut template inside the vehicle (Figure 9). Remove that section of trunk floor pan from the vehicle.



Figure 9 – Remove Floor Pan Section

10. Repeat this process for the opposite side of the vehicle.

III. INSTALLING THE DETROIT SPEED FRAME RAIL SECTIONS

1. Do each frame rail modification one side at a time to avoid vehicle distortion.
2. On the passenger side inside frame rail, mark a vertical line at the front edge of factory rear leaf spring bushing sleeve. Draw a line on the bottom side of the frame rail. Measure forward 11" from the front edge of the bushing sleeve and draw a line on the bottom surface of the frame rail (Figure 10 on the next page). On the driver's side inside frame rail, measure forward 12" from the leaf spring bushing sleeve and draw a line on the bottom surface of the frame rail.

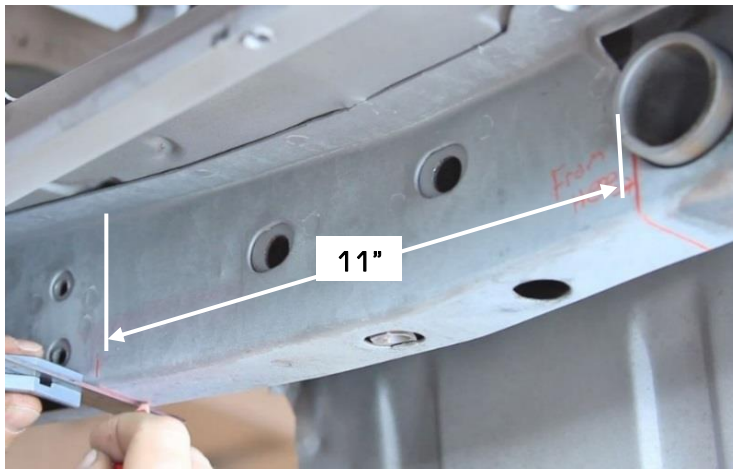

Figure 10 – Passenger Side Frame Rail

3. Measure forward 29" from the front edge of the rear leaf spring bushing sleeve and draw a line on the bottom side of the frame rail. Draw a cut line along the inside bottom corner of the frame rail forward to the rear cross member. Draw a vertical cut line at the corner of the frame rail and the cross member (Figure 11).

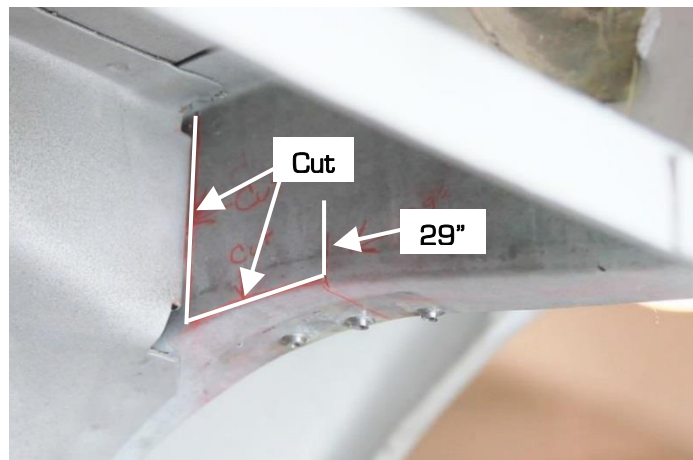

Figure 11 – Locate Inner Frame Rail Cut Lines

4. Draw a fold line on the bottom of the frame rail from the cross member and continue that fold line vertically on the outside frame rail. Continue the cut line drawn on the bottom side of the frame rail at the 29" marked location vertically on the outside frame rail. Draw a connecting cut line at the bottom outside corner of the frame rail connecting the 2 vertical lines on the outside frame rail (Figure 12).

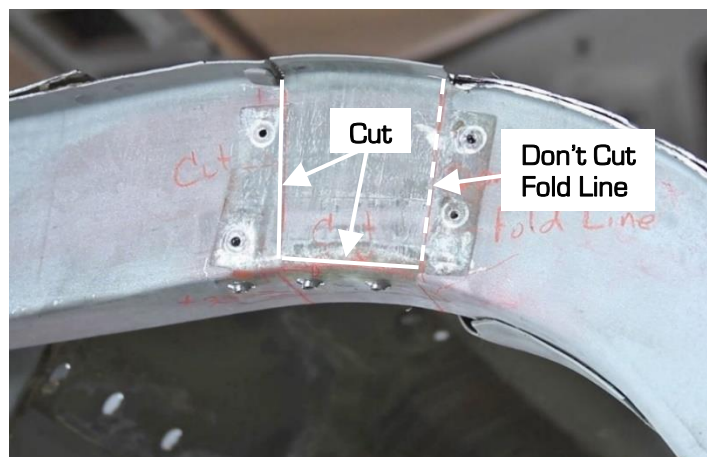

Figure 12 – Locate Outer Frame Rail Fold & Cut Lines

5. Position the provided Detroit Speed frame rail section to the bottom of the frame rail. The front of the frame rail section will line up with the front fold line located at the back of the cross member in the previous step. Using the back of the angled Detroit Speed frame rail section, draw an angled cut line along the bottom of the frame rail (Figure 13).

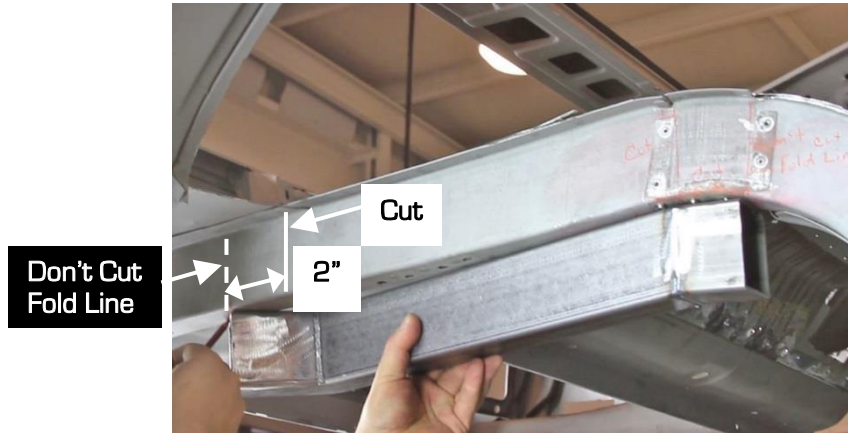

Figure 13 – Locate Detroit Speed Frame Rail Section

6. Draw a vertical fold line on the outside of the frame rail from the angled cut line drawn on the bottom of the frame rail in the previous step. Draw a cut line 2" forward of the vertical fold line drawn on the outside frame rail. Connect the 2 lines by drawing a cut line along the outside bottom corner of the frame rail (Figure 14). Draw a vertical cut line on the inside of the frame rail where the angled cut line was drawn on the bottom of the frame rail.

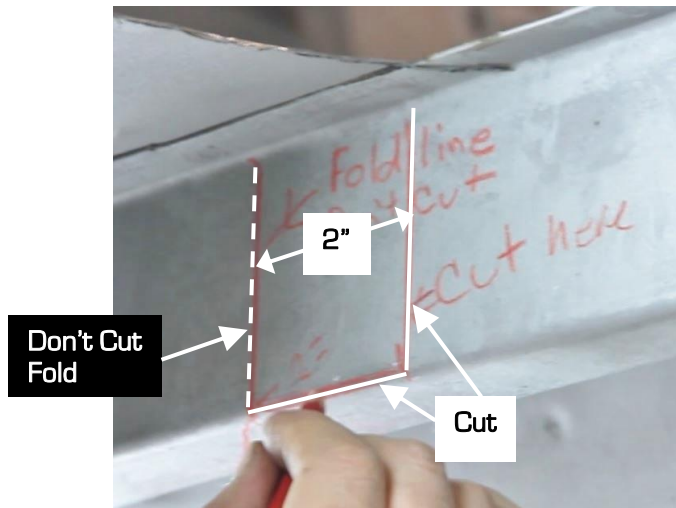

Figure 14 – Locate Fold & Cut Lines

7. Locate and drill out the spot welds from inside the trunk above the frame rail (Figure 15).



Figure 15 – Drill-Out Spot Welds

8. Cut the frame rail where you previously drew the cut lines to remove this section of the factory frame rail (Figure 16).



Figure 16 – Remove Frame Rail Section

9. Using the front corner radius of the mini-tub floor cut template, draw an arc connecting the outside of the frame rail to the front cut line where the factory inner tub was removed (Fig. 17).



Figure 17 – Connect Frame Rail to Inner Tub Cut-Out

10. Measure the flange overhang from the outside frame rail where the front radius of the factory inner tub meets the parallel cut line on the floor pan. Transfer this dimension point to the inside of the floor pan as it should be close to your traced template line. (Figure 18).



Figure 18 – Transfer Flange Dimension

11. Place the template back on the frame rail and use it as a straight edge to connect this transferred point straight back to where the floor pan flange meets up with the outside frame rail (Figure 19).



Figure 19 - Connect Transferred Lines

12. Cut this section of floor pan flange away. Weld the two layers of sheet metal together above the frame rail (Figure 20).



Figure 20 - Cut & Weld Sheet Metal Layers

13. Drill plug weld holes in the outside and bottom side of the folded sections of the frame rail. Place the Detroit Speed frame rail section into the vehicle, placing the front edge inside the folded cut sections of the factory frame rail. Line up the back edge of the Detroit Speed frame rail section with the 11" and 12" marks that were made in Step 2 (Figure 10). Clamp the Detroit Speed frame rail section in place (Figure 21).



Figure 21 - Clamp Detroit Speed Frame Rail in Place

14. Tack weld and plug weld the folded section of the factory frame rail to the Detroit Speed frame rail section. Continue welding the folded flange to the frame rail section. Fully weld the Detroit Speed frame rail section in all locations to the factory frame rail (Figure 22).



Figure 22 - Weld-In Detroit Speed Frame Rail Section

15. Grind the welds in the back inside corner of where the Detroit Speed frame rail section meets the factory frame rail. Bend the provided inside frame rail doubler plate and fit it to the inside of the frame rail. Clamp it in place and tack weld it to the frame rail. Remove the clamps and plug weld the pre-drilled holes in the double plate and fully weld it to the frame rail (Figure 23).



Figure 23 - Weld Inside Frame Rail Doubler Plate

16. Clamp the provided 90° doubler plate at the front corner where the cross member meets the inside frame rail. Once its tack welded in place, remove the clamp and plug weld it to the cross member and frame rail (Figure 24).

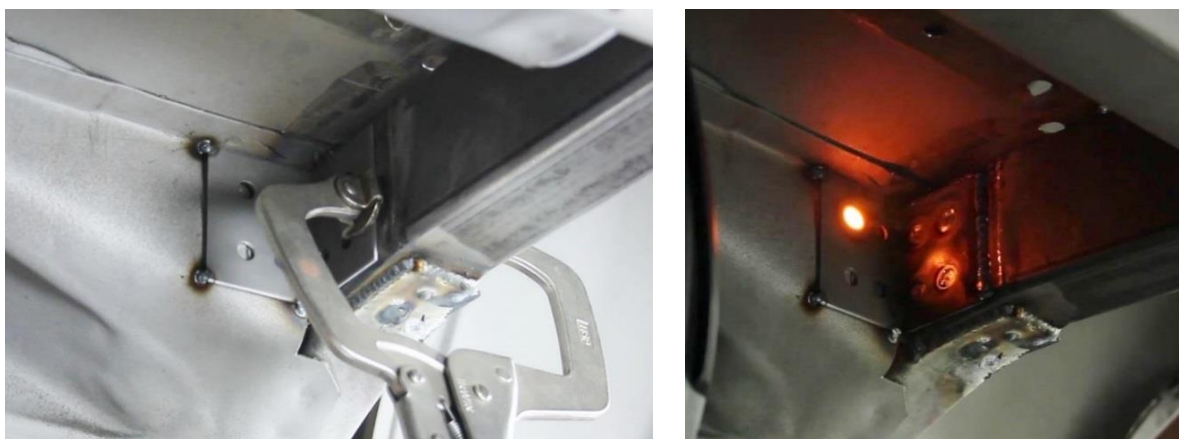

Figure 24 - Weld 90° Doubler Plate

17. Place the provided bottom frame rail doubler plate on the bottom side of the frame rail at the back corner of the Detroit Speed frame rail section. Tack weld it in place. Plug weld the pre-drilled holes in the doubler plate and fully weld it in place (Figure 25).

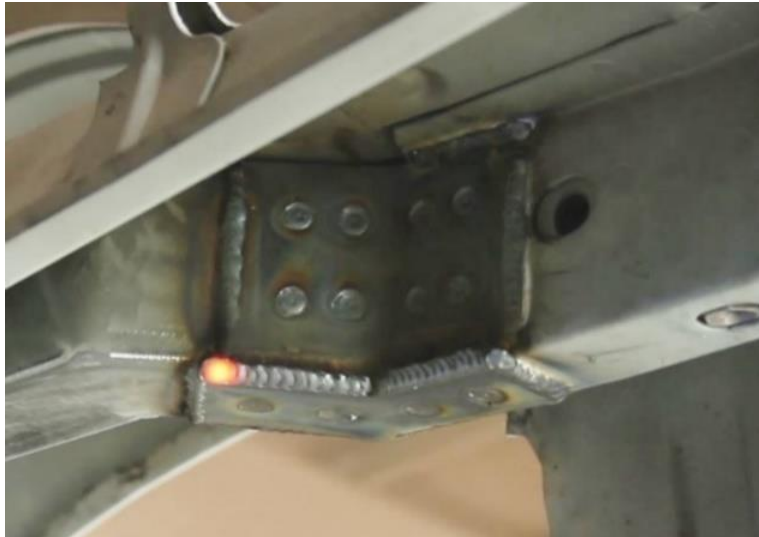

Figure 25 - Weld Bottom Frame Rail Doubler Plate

18. Repeat this process for the opposite side of the vehicle.

IV. INSTALLING THE DETROIT SPEED MINI-TUBS

NOTE: If you are installing the Detroit Speed QUADRALink, Detroit Speed recommends installing the upper cross member assembly and the upper link pockets into the vehicle before installing the mini tubs.

1. Fit the Detroit Speed mini tub into the vehicle. Clamp it in place to the frame rail. **NOTE:** DSE recommends placing your wheel and tire in the mini tub to make sure you have sufficient clearance between the tire and the mini tub before you weld them in place. DSE recommends using your rear axle to help locate your wheel and tires.
2. Begin welding the front corner of the Detroit Speed mini tub to the stock outer tub. Continue stitch welding around the mini tub to the stock outer tub from underneath the tub as well as fully welding it to the floor pan inside the vehicle (Figure 26).



Figure 26 - Weld Mini-Tub to Stock Outer Tub

3. Stitch weld the Detroit Speed mini-tub to the frame rail. Tap the factory tub flange down to meet the mini tub. Stitch weld the factory tub flange to the Detroit Speed mini-tub (Figure 27 on the next page).

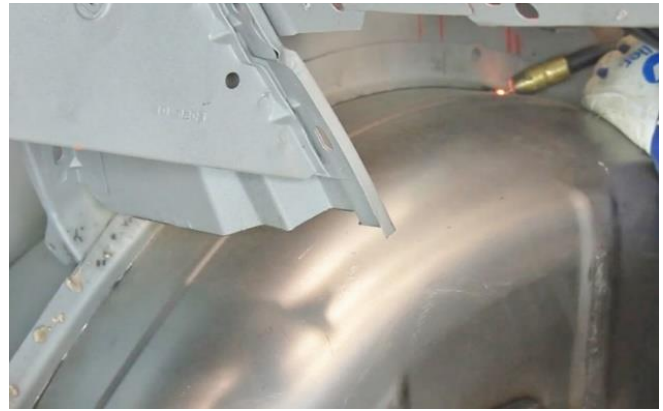

Figure 27 - Stitch Weld Mini-Tub to Frame Rail & Outer Tub Flange

4. Go to Step 6 if you have a coupe, follow Step 4 & 5 if you have a fastback. Trim the rear seat corner support to sit flush with the new Detroit Speed mini-tub. Once the rear seat support fits correctly, fabricate a weld flange with pre-drilled plug weld holes (Fig. 28). Continue to Step 7.



Figure 28 - Modify Rear Seat Support

5. Clamp the rear seat corner support in place and tack weld it to the existing rear seat support. Remove the clamp and fully weld the rear seat support in place (Figure 29). Grind the welds smooth for a clean finish.



Figure 29 - Weld Rear Seat Support to Mini-Tub (Fastback)

6. Modify and fit the lower section of decklid hinge bracket to the Detroit Speed Mini-Tub. Weld the upper part of the hinge mount back to the original flange piece still on the vehicle. Stitch weld and plug weld the lower section into position. Fit the rear seat corner support that was removed earlier to the Detroit Speed Mini-Tub. A small extension piece will probably have to be added to the top outboard edge since the bracket will be shifted inboard by the Mini-Tub. Drill holes for plug welding in the applicable areas and tack weld the bracket into position. Weld any other remaining brackets back into position that were removed from the stock tubs (Figure 30).



Figure 30 - Weld Rear Seat Support & Decklid Hinge to Mini-Tub (Coupe)

7. Position the upper and lower seat brackets that were removed earlier and weld them back in place (Figure 31).



Figure 31 - Re-attach Upper & Lower Seat Brackets

8. Bend the rear interior panel bracket back in place and trim as needed to fit against the Detroit Speed mini-tub. Fully weld the interior panel bracket to the mini tub (Figure 32).



Figure 32 - Re-attach Rear Interior Panel Bracket

9. Re-position the seat belt anchor and weld it back in place. If you are installing the Detroit Speed QUADRALink, it needs to be placed to the inside flange of the upper link pocket (Figure 33). Drill a hole in the floor pan for the new seat belt anchor and weld the bracket in place.



Figure 33 – Re-position the Seat Belt Anchor

10. Repeat this procedure for the opposite side of the vehicle (Figure 34).



Figure 34 – Installed Detroit Speed Mini-Tub

V. FINAL ASSEMBLY

1. Paint all bare metal to prevent the formation of rust.
2. Remove the rear seat cover and padding. Modify the seat frame to clear the Detroit Speed Mini-Tubs. Install the bare seat frame and mark points of interference between the seat frame and Mini-Tubs. These points will have to be modified to clear the new tubs.
3. Modify rear interior trim panels as necessary to fit the Detroit Speed Mini-Tubs.
4. Re-cover the seat bottom, then reinstall the package tray, rear interior quarter trim panels, carpet padding, carpet, seats, gas tank, rear suspension, and any additional interior panels that were removed for the installation process.

If you have any questions before or during the installation of this product, please contact Detroit Speed at tech@detroitsspeed.com or 704.662.3272

Legal Disclaimer: Detroit Speed is not liable for personal, property, legal, or financial damages from the use or misuse of any product we sell. The purchaser is solely responsible for the safety and performance of these products. No warranty is expressed or implied.