

**Detroit Speed**  
**C2/C3 SpeedRay Front Suspension**  
**1963-82 Corvette**  
**P/N: 032070DS, 032070-SDS, 032070-DDS, 032070-RDS, 032071DS,**  
**032071-SDS, 032071-DDS & 032071-RDS**

The Detroit Speed Corvette SpeedRay front suspension improves handling and ride quality by utilizing Detroit Speed's unique suspension geometry. The DSE Corvette SpeedRay front suspension has been designed, engineered, and developed for the road and track. This system blends the benefits of the current OEM technology and aftermarket performance into one product.



Item #	Description	Quantity
1	Cradle Assembly, Powder Coat (Satin Black)	1
2	Cradle Crossmember Adapter Plates	2
3	Upper Coilover Mount Kit (Fab Version)	2
4	Lower Control Arm Assembly, Powder Coat (Gloss Black), LH and RH	2
5	Upper Control Arm Assembly, Powder Coat (Gloss Black), LH and RH	2
6	Upright Assembly, LH and RH	2
7	Rack & Pinion Assembly	1
8	Splined Sway Bar	1
9	Sway Bar Arm, LH and RH	2
10	Coilover Shock Assembly	2
11	Coilover Spring	2
12	Tie Rod Hardware Kit	1
13	Hardware Kit	1
14	Instructions	1

Specifications – Detroit Speed C2/C3 Front Suspension	
Total Suspension Travel	6"
Ride Height*	7.6" ±1.0"
Static Camber	-0.5° ±.2°
Static Caster	7.5° ±.5°
Static Toe	0° ±.1°
Steering Ratio	13:1
Steering Wheel Turns Lock to Lock	2
Max Turning Angle (Outside Wheel)	27.5°
Ackerman Angle (Full Turn)	5.2°
Total Bump Steer (20" toe span)	.039"
*Measured from bottom of Detroit Speed front cradle to the center of the hub	

Wheel & Tire Fitment (C2/C3 Stock Body)					
Diameter (in.)	Width (in.)	Backspacing (in.)	Lug Nut Thread Pitch	Recommended Tire Size	Comments
17*	8.0	4.00	5 X 4.75" M12x1.5	245/45R17	
	9.0	4.50		255/40R17	
	9.5	4.50		265/40R17	Max Width Recommended
18	8.0	4.00		245/40R18	
	9.0	4.50		255/35R18	
	9.5	4.50		265/35R18	Max Width Recommended
Wheel & Tire Fitment (C2/C3 w/Fender Flares)					
18	10.5	4.50	5 X 4.75" M12x1.5	295/35R18	
	11.5	4.50		315/30R18	Max Width Recommended
Wheel & Tire Fitment (Detroit Speed Fender Flares P/N: 010113DS)					
18	11.5	4.50	5 X 4.75" M12x1.5	315/30R8	Max Width Recommended
19	11.5	4.50		305/30R19	

\* 17" wheels require a minimum inside wheel diameter of 16.250"

**Caution:** Some brake applications will not work with 17" wheels. Flush mount valve stems may also be required on wheels with a behind center valve stem location.

**NOTE:** All work should be performed by a qualified welder and technician.

Accessory Components - Detroit Speed C2/C3 Front Suspension	
Brakes	DSE has Baer & Wilwood brake packages for our front suspension. Any C6 Corvette brake application will work with our front suspension system
Rack & Pinion Fittings (Included)	Return (low): 9/16"-18 JIC to 3/4"-16 O-Ring Pressure (high): 9/16"-18 JIC to 9/16"-18 O-Ring DSE hose kit available (P/N: 091304DS)
Rack & Pinion Input Shaft	17mm -36 to 3/4"-DD, Complete kits available from Detroit Speed (1969-76 Corvette, P/N: 092526DS) **
Steering Column	Stock* or  Ididit - 1963-66* (P/N: 1120770010) 1967* (P/N: 1300710010) 1968 (P/N: 1120700010) 1969-76 (P/N: 1520710010)
Wheel Stud Kit (Optional)	ARP 100-7708 - M12-1.5 x 2.5" L GM Wheel Stud Kit

\*Steering column must be shortened so the overall length from the top of the upper tube of the column to the bottom of the output is 35-7/8" for 1968-82 Corvette and 29-5/8" for 1963-67 Corvette. For the C2 Ididit column, you can shorten the column by removing the pin on the collapsible shaft inside the tube. Shorten the inside shaft by 3.100", re-pin and weld.

\*\*For 1963-67 applications, the length of the 3/4"DD steering shaft needs to be 14-3/8" long.

Engine Fitment - C2/C3 Front Suspension				
SBC/BBC Engines				
Engine	Mounting	Oil Pans	Headers	Comments
Small Block Chevrolet	Stock type mounts and brackets	Stock Or Aftermarket	Dynatech P/N: 730-10010  Hedman Headers P/N: 68360	The set screws on the rack and pinion u-joint need to be shortened to clear the headers
Big Block Chevrolet	Stock type mounts and brackets	GM P/N: 12495360 (one-piece rear main seal)	Custom	
LS Engines				
Engine		Oil Pans	Headers	Comments
LS1*, LS2* & LS3*	Polyurethane Engine Mount Kit P/N: 060403DS & Hooker Engine Mount Brackets P/N: 12611HKR	Stock GM 4 <sup>th</sup> Gen F-body P/N: 12628771, Stock GM LS1, LS2, or LS3  Champ P/N: LS1000, Mast Motorsports P/N: 401-111 or Holley P/N: 302-2	Custom	
LS7*, LS9*		Stock GM Oil Pan NOTE: Use GM P/N: 25534412 or Peterson Fluid Systems for dry sump fittings to drain oil pan	Custom	

\*NOTE: For aftermarket LS engines (i.e., Mast Motorsports), refer to manufacturer for specific oil pan usage.

## Hardware Kit Checklist - Detroit Speed C2/C3 Front Suspension

Part Number	Description	Quantity	Check
<b>9303294</b>	<b>Cradle Mounting Hardware Kit</b>	<b>1</b>	
950104FS	9/16"-18 x 1-1/2" L Socket Head Cap Screw, Black Oxide	2	
960022FS	9/16"-18 Nylock Nut, Yellow Zinc	2	
970020FS	9/16" SAE Washer, Yellow Zinc	2	
980051FS	7/16"-20 x 1" L Hex Head Bolt, Yellow Zinc	8	
950042FS	7/16"-20 x 1-1/4" L Hex Head Bolt	4	
950105FS	7/16"-20 x 1-1/2" L Socket Head Cap Screw, Clear Zinc	4	
970032FS	7/16" SAE Flat Washer, Yellow Zinc	20	
960050FS	7/16"-20 Nylock Nut, Yellow Zinc	8	
<b>9303299</b>	<b>Rack &amp; Pinion Hardware Kit</b>	<b>1</b>	
980002FS	1/2"-20 x 2-3/4" L Hex Head Bolt	2	
960004FS	1/2"-20 Nylock Nut, Yellow Zinc	2	
970037FS	1/2" SAE Washer, Yellow Zinc	2	
970064FS	1-5/8" OD x 1/2" ID Washer	2	
960076FS	9/16"-18 RH Jam Nut, Clear Zinc	2	
<b>9303293</b>	<b>Front sway Bar Hardware Kit</b>	<b>1</b>	
9303292	sway bar Bracket Assembly	2	
9303073	1-1/4" Split Lock Collar Assembly	2	
99030340	1-1/4" sway bar Composite Bushing	2	
99040009	Super Grease	1	
9303220	sway bar End Link Assembly	2	
980014FS	3/8"-16 x 2" L Socket Head Cap Screw, Black Oxide	2	
960069FS	3/8"-16 Square Nut	2	
980096FS	5/16"-18 x 1" L Flange Head Hex Bolt	4	
960081FS	M12 x 1.75 Flanged Lock Nut, Clear Zinc	4	
<b>9303298</b>	<b>Lower Control Arm Hardware Kit</b>	<b>1</b>	
980034FS	9/16"-18 x 3-3/4" L Hex Head Bolt, Yellow Zinc	4	
960022FS	9/16"-18 Nylock Nut, Yellow Zinc	4	
970020FS	9/16" SAE Washer, Yellow Zinc	8	
<b>9303303</b>	<b>Upper Control Arm Hardware Kit</b>	<b>1</b>	
920009FS	Shim - 1/8" Thick, Clear Zinc	8	
980107FS	7/16"-14 x 2-1/4" L Hex Head Bolt, Yellow Zinc	4	
960017FS	7/16"-14 Nylock Nut, Yellow Zinc	4	
970032FS	7/16" SAE Washer, Yellow Zinc	8	
<b>9303297</b>	<b>Coilover Shock Hardware Kit (Fab Version)</b>	<b>1</b>	
980043FS	1/2"-20 x 4" L Hex Head Bolt, Yellow Zinc	2	
980026FS	1/2"-20 x 2-1/2" L Hex Head Bolt, Yellow Zinc	2	
960004FS	1/2"-20 Nylock Nut, Yellow Zinc	4	
970037FS	1/2" SAE Washer, Yellow Zinc	4	
99030475	3/4" O.D. x 1-1/4" L Upper Shock Bolt Spacer	2	
99030321	3/4" O.D. x 5/8" L Lower Shock Bolt Spacer	2	
031060	Detroit Speed/JRi Spanner Tool	1	
031062	Torrington Bearing Set	1	

Fastener Torque Specifications - Detroit Speed C2/C3 Front Suspension		
Application	Torque (ft-lb)	Threads
Crossmember Adapter Plate Front 7/16" Bolts	70	Blue Loctite 242
Crossmember Adapter Plate Rear 9/16" Bolts	95	Anti-Seize
Cradle to Adapter Plate Bolts	65	Blue Loctite 242 (rear)
Cradle to Crossmember Bolts	45	Anti-Seize
Lower Control Arm Mounting Bolts	95	Anti-Seize
Rack and Pinion Bushing Mounting Bolts	85	Anti-Seize
Rack and Pinion Bracket Bolts	70	Red Loctite 262
Tie Rod End Jam Nut	45	Anti-Seize
Coilover Shock Mounting Bolts	60	Anti-Seize
Upper Control Arm Mounting Bracket Bolts	55	Anti-Seize
Upper Control Arm Bushing Bolts	55	Anti-Seize
sway Bar Bushing Bracket Mounting Bolts	25	Blue Loctite 242
sway Bar Shaft Clamp Screw	14	Blue Loctite 242
sway Bar Arm Mounting Bolt	30	Blue Loctite 242
sway Bar Link Nuts	45	Red Loctite 262
Lower Control Arm Ball Joint Stud Nut	20 then turn an additional 180°	Red Loctite 262
Upper Control Arm Ball Joint Stud Nut	40	
Tie Rod End Stud Nut*	35	Anti-Seize
Wheel/Hub Bearing Mounting Bolts	95	Red Loctite 272
Steer Arm Mounting Bolts	60	Red Loctite 272
Front Brake Caliper Mounting Bracket Bolts	125	Red Loctite 272
Wheel Stud Nuts	100	
* Always tighten slotted nuts to line up with the cotter pin hole.		

**IMPORTANT:**

The Detroit Speed upper and lower control arms **CAN NOT** be powder coated a different color other than the way they are shipped since they come already assembled from DSE. The temperatures from this process will destroy the control arms beyond repair.

The Detroit Speed upper control arms **CAN NOT** be taken apart because of the precise assembly procedure at DSE. The upper control arm cross shaft nuts are torqued and then pinned in place. Failure to follow the correct procedure will damage the upper control arms beyond repair. Any attempt at taking apart any of the Detroit Speed subframe components before calling DSE will void any warranty. If you have any questions please call Detroit Speed at 704-662-3272.

If the lower control arm ball joint stud needs to be serviced after the initial torque setting listed above, use the following information to re-assemble the lower control arm and upright:

1. Before you remove the ball joint nut, make a line with a marker from the top of the nut down to the upright and then loosen the ball joint nut.
2. Upon re-assembly, torque the ball joint nut to 20 ft-lbs. and then tighten the nut until the line on the nut goes back to the line on the upright so it is back in the same location as the initial torque setting.

If the upper ball joint needs to be replaced, the Detroit Speed upright assembly must be returned to DSE to be serviced. Failure to follow this procedure before calling Detroit Speed will void any warranty. If you have any questions please call Detroit Speed at 704-662-3272.

**CAUTION:**

The Detroit Speed serial number tag is the best identification record of your C2/C3 front suspension when contacting DSE to determine when it was assembled for any warranty issues should you need them (Figure 1). Detroit Speed does not recommend re-powder coating the front cradle as that will cause permanent damage to your serial tag number. If it is damaged it would be much more difficult to properly ID your Detroit Speed C2/C3 front suspension.



Figure 1 - Serial Tag

**Installation:**

1. Prepare the frame by removing the entire front suspension and steering linkage, including the steering box from the frame. **NOTE:** You will need to keep your factory front lower control arm nut plates to be re-installed later (Figure 2).

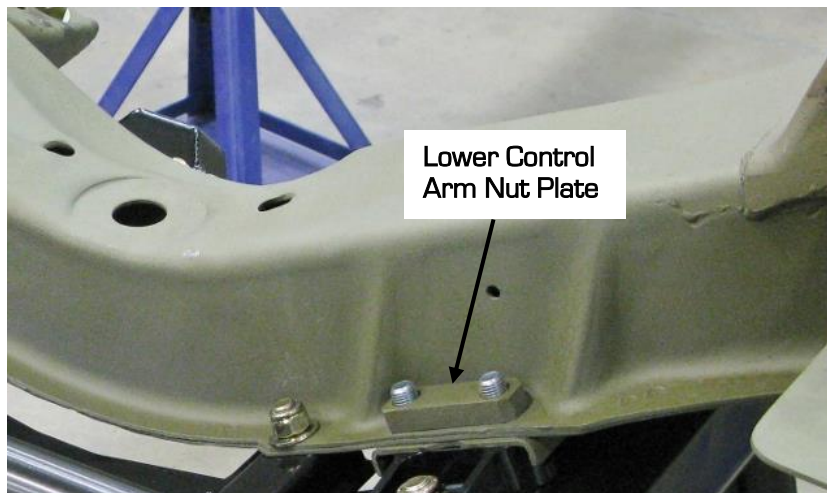

Figure 2 - Lower Control Arm Nut Plate

2. Install the Detroit Speed coilover mount assemblies into the frame at the stock upper shock mount. Start by removing the factory upper control arm bolts from the bracket. **NOTE:** You will be able to re-install these bolts later or use the provided hardware in this kit. Layout some cut lines on the stock upper shock mount using the Detroit Speed coilover mount assemblies. You can draw a line perpendicular to the frame at 2-5/8" rearward from the center of the front upper control arm mount hole and 1" forward from the center of the rear upper control arm mount hole (Figure 3 on the next page).

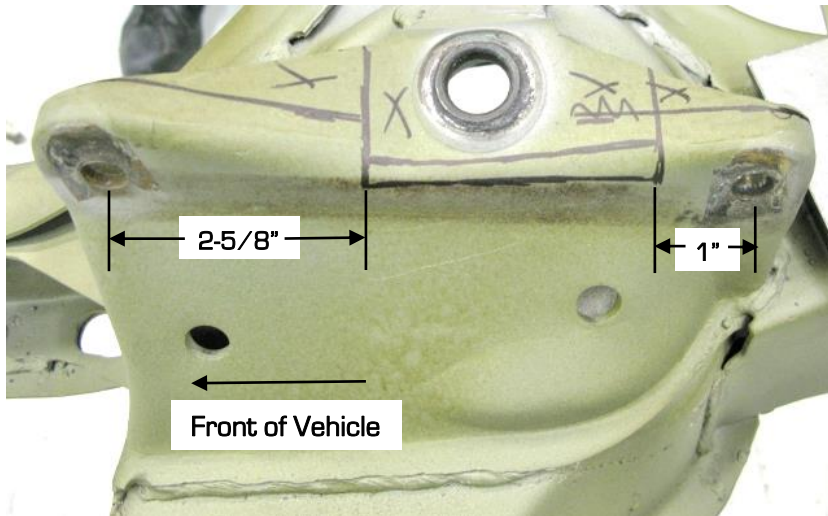

Figure 3 - Layout Cut Lines

3. Draw a line parallel with the frame, at the top of the radius of the factory upper shock mount as well as across the flanged edge (Figure 4).

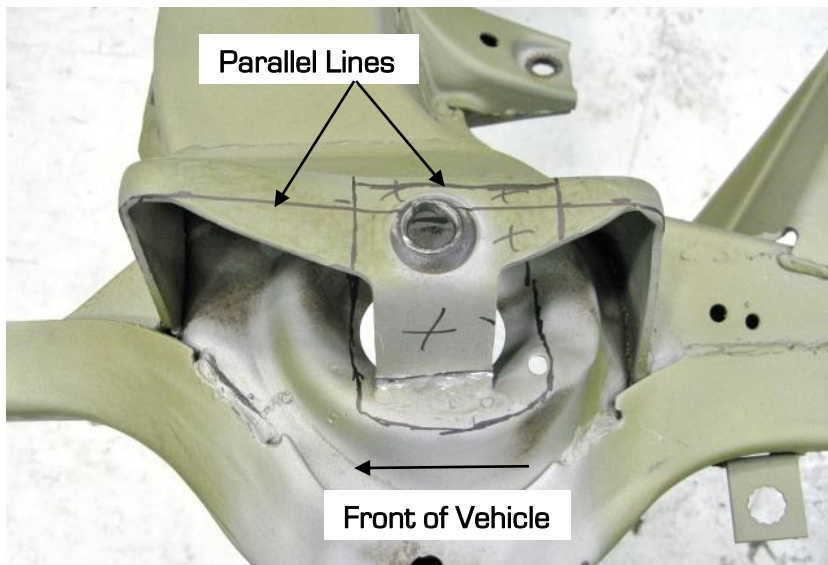

Figure 4 - Layout Parallel Cut Lines

4. Using a cutoff wheel, cut along your marked lines to cut out a section of the upper shock mount to fit the Detroit Speed coilover mount (Figure 5).

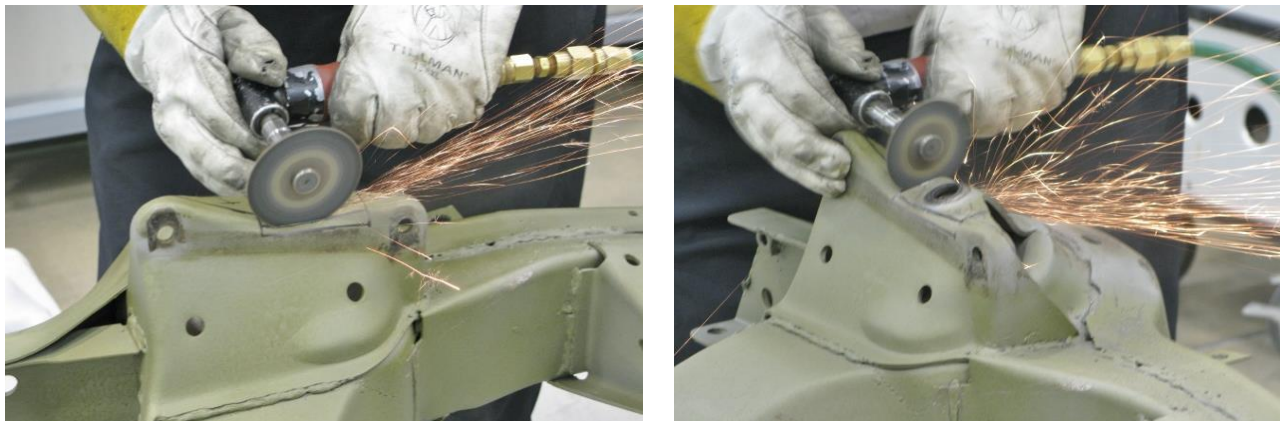

Figure 5 - Cut Factory Upper Shock Mount

5. Cut the outer part of the bracket above the factory weld to remove the section of the upper shock mount area (Figure 6).



**Figure 6 - Cut Factory Upper Shock Mount Bracket**

6. Next, square up the upper control arm bracket by cutting off the extra flange material (Figure 7). Grind the upper control arm bracket smooth where you made your cuts.

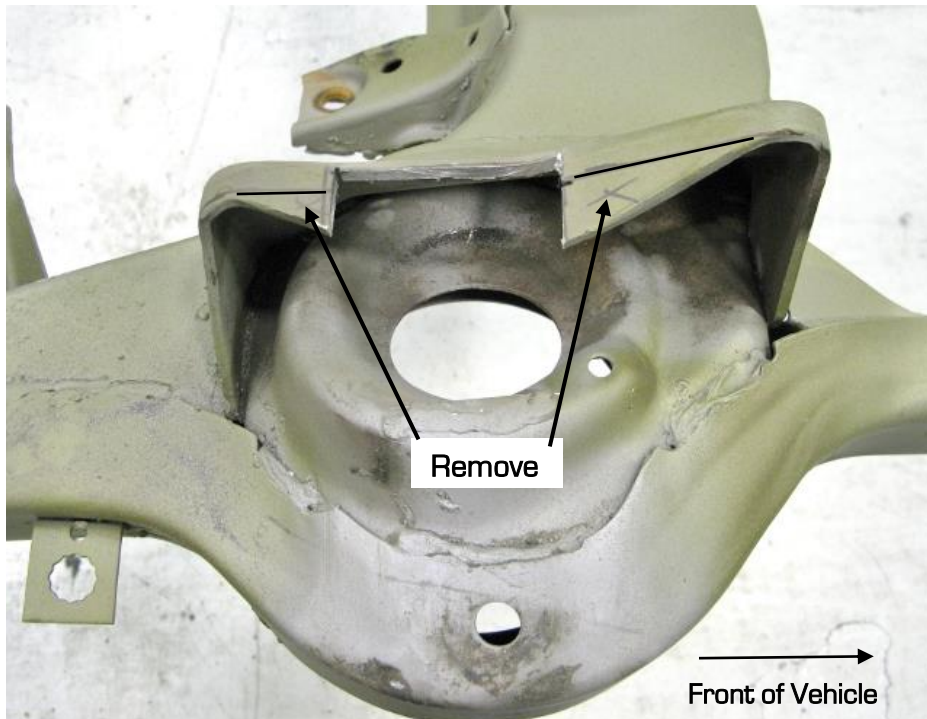

**Figure 7 - Remove Extra Flange Material**

7. Position the Detroit Speed coilover shock mount against the factory upper control arm mount and trace the coilover pocket to cut away the stock upper spring perch (Figure 8 on the next page).



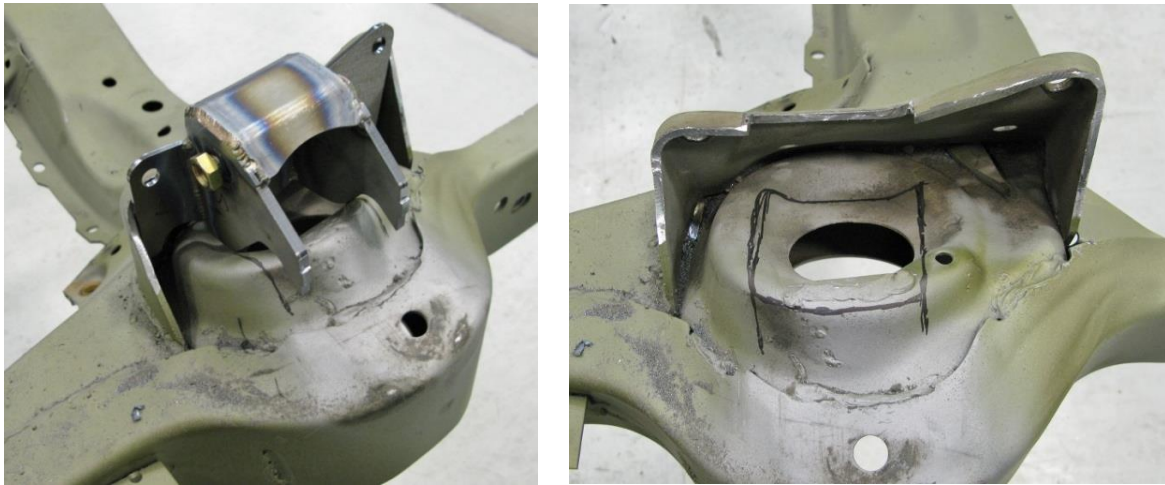

**Figure 8 Trace the Detroit Speed Upper Shock Pocket**

8. Cut out the area of the upper spring perch that was marked in the previous step (Figure 9).

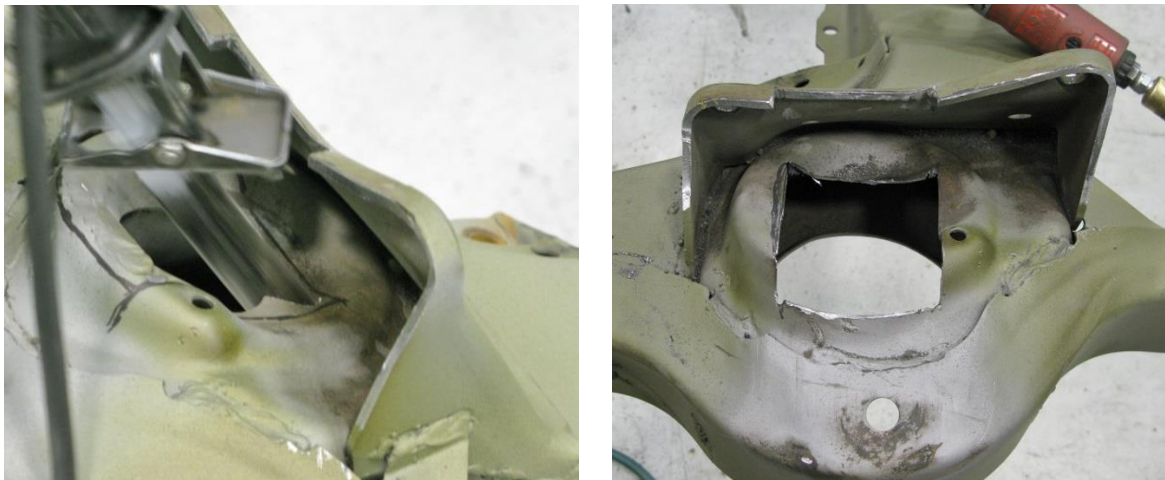

**Figure 9 - Cut Out the Factory Upper Spring Perch**

9. Test fit the Detroit Speed coilover pocket by bolting it in place with the provided 7/16"-20 x 2-1/4"L hex head bolts, nuts and washers. (Figure 10). You may need to trim more material away from the upper spring perch due to frame variation as well as the stock upper control arm mount so that the coilover pocket sits flush against the stock mount. Once the coilover pocket fits, grind your cut lines and prepare the area to have it welded to the frame.

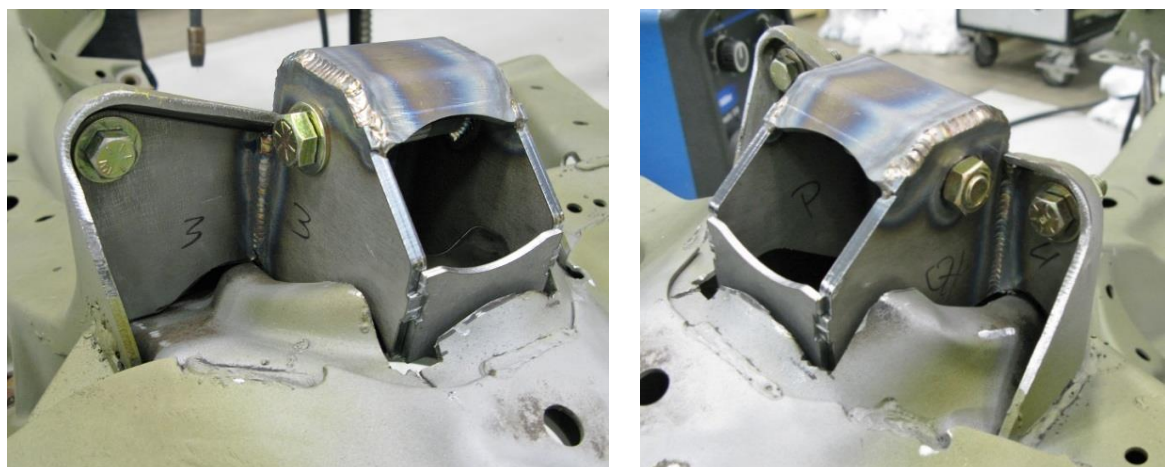

**Figure 10 - Test Fit Detroit Speed Coilover Pocket**

10. Weld the Detroit Speed coilover mount around the back side to the factory upper control arm mount and around the remaining factory upper spring perch in the frame. Weld all sides of the upper coilover mount together including the outboard closeout. (Figure 11).

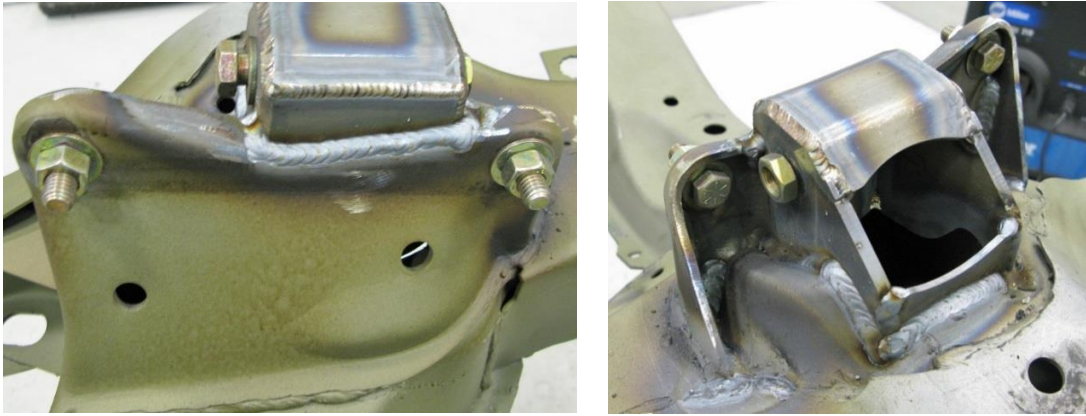

Figure 11 - Weld Detroit Speed Pocket to Factory Upper Control Arm Mount

11. Weld the bottom side of the coilover pocket to the spring perch (Figure 12).

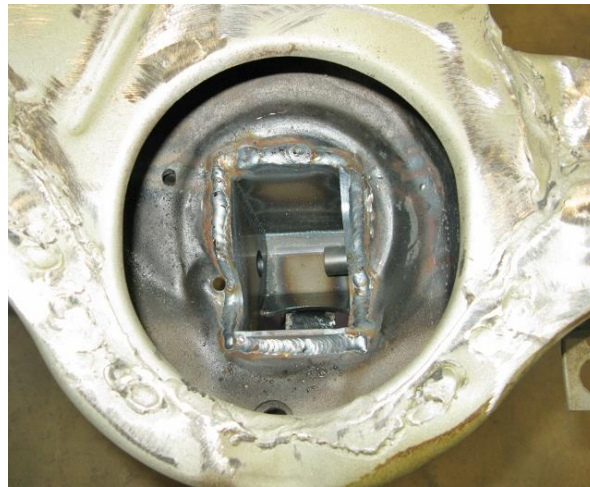

Figure 12 - Weld the Bottom of the Coilover Pocket to the Spring Perch

12. Repeat steps 2-11 for the opposite side of the vehicle. Grind all welds smooth for a clean finish (Figure 13).

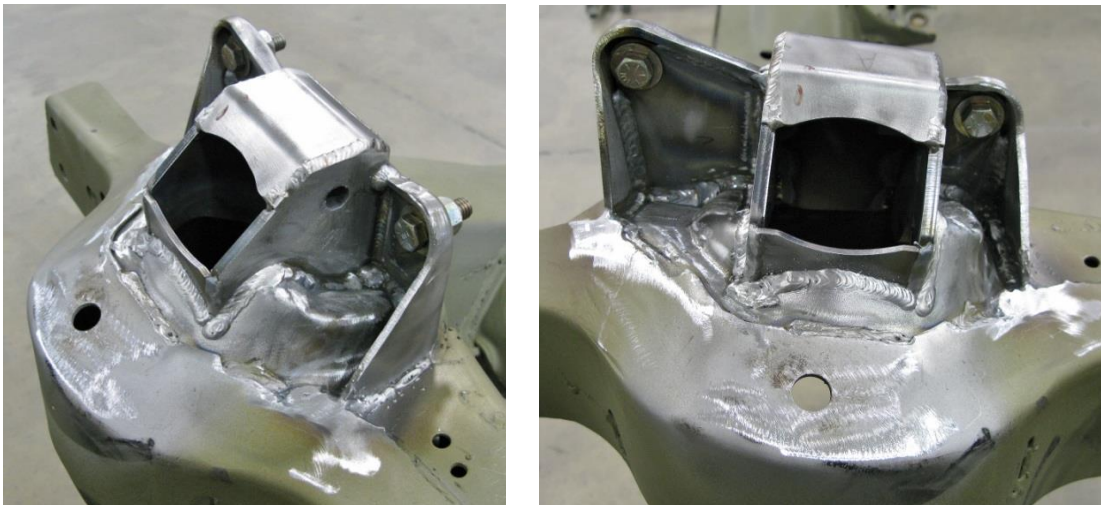

Figure 13 - Finish Grind Detroit Speed Coilover Pockets

13. Grind the factory lower control arm brackets to remove any burrs or welds (Figure 14). At this point the fabrication work is complete on the frame. Prepare and paint the upper coilover and control arm mount along with any bare metal areas on the frame before installing the suspension.



Figure 14 - Grind Lower Control Arm Brackets

14. Before installing the cradle crossmember adapter plates to the front crossmember, chase the tapped holes using a 7/16"-20 tap or one of the provided 7/16"-20 bolts to remove any coating that could cause the hardware to cross thread the tapped holes when installing the cradle assembly.
15. Position the cradle crossmember adapter plates to the front crossmember and make sure that all three mounting holes line up (Figure 15). You may need to clearance the holes in the crossmember due to frame variation of aftermarket components.



Figure 15 - Position Cradle Crossmember Adapter Plates

16. Install the adapter plates to the front crossmember using the 4 provided  $7/16$ "-20 x 1-1/2"L socket head cap screws with a  $3/8$ " hex drive using Medium Strength blue Loctite 242 on the threads. They will bolt into the factory front lower control arm nut plates (Figure 16).

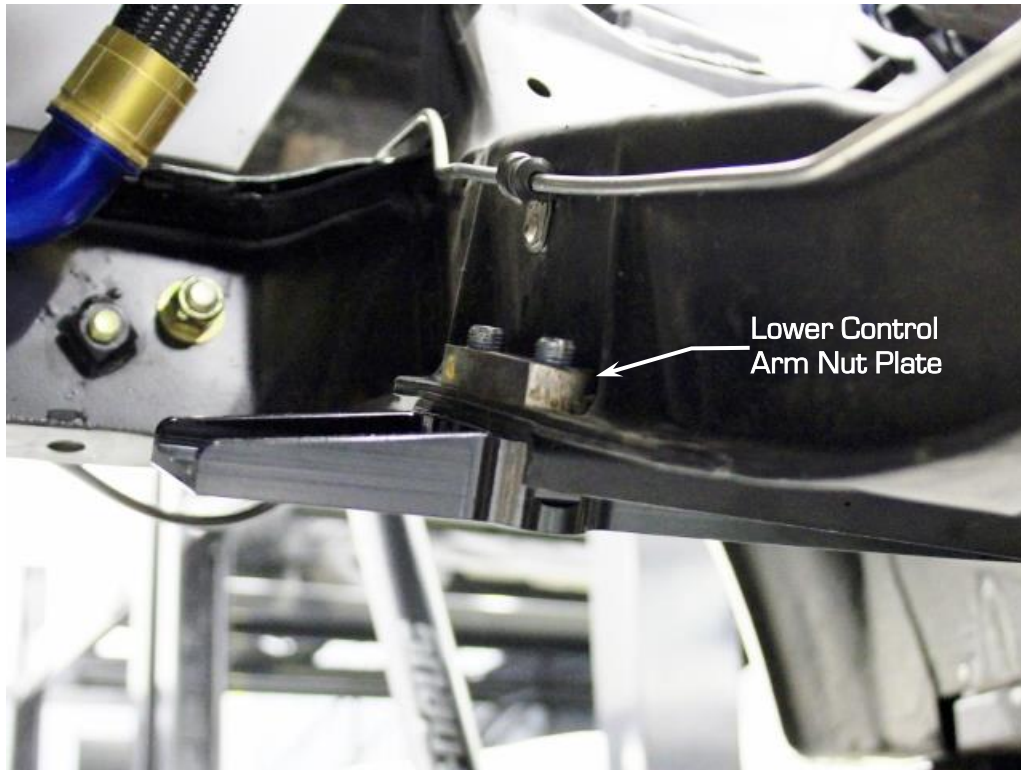

Figure 16 - Install Adapter Plates to Nut Plates

17. Install the 2 provided  $9/16$ "-18 x 1-1/2"L socket head cap screws, Nylock nuts and washers through the rear lower control arm mount in the crossmember (Figure 17). **NOTE:** Use anti-seize on the threads of these bolts. Torque the  $7/16$ "-20 bolts from step 16 to 70 ft-lbs. and torque the  $9/16$ "-18 hardware to 95 ft-lbs.



Figure 17 - Install Adapter Plates to Crossmember

18. Bolt the Detroit Speed front cradle assembly to the crossmember adapters using the provided 7/16"-20 hardware. **NOTE:** Be sure the front cradle is free of any loose media or particles that may have collected in the cradle from powder coat. Do this with compressed air.
19. Make sure the cradle sits flush against the cradle adapter plates. You may need to grind the crossmember brackets down so they sit below the adapter plates. Start four of the 7/16"-20 x 1"L hex head bolts through the cradle and into the tapped holes in the cradle adapters at the rear of the crossmember, use Medium Strength blue Loctite 242 on the threads of these bolts before installing them.

**NOTE:** On later or aftermarket C3 cross members, the center mounting holes may need to be located and drilled out (Figure 18). With the cradle centered and tight to the adapter plates, locate the four center mounting holes. Center punch and drill out the four locations for the provided 7/16"-20 x 1" L hex head bolts. Chamfer the holes when finished.



Figure 18 - Locate & Drill Mounting Holes

20. Four of the remaining 7/16"-20 x 1"L hex head bolts, Nylock nuts and washers go through cradle and through the factory holes in the middle of the crossmember. The four 7/16"-20 x 1-1/4"L hex head bolts go through the front of the cradle and through the cradle adapters with the provided 7/16"-20 Nylock nuts and washers. Use anti-seize on the threads of these eight bolts (Figure 19). Center the cradle and torque the four bolts from the previous step to 65 ft-lbs and torque the eight bolts from this step to 45 ft-lbs.



Figure 19 - Install Cradle Assembly

21. Install the Detroit Speed lower control arms into the cradle using the provided 9/16"-18 x 3-3/4"L hex head bolts, Nylock nuts and washers. Use anti-seize on the threads before installing the bolts through the cradle assembly. The 9/16"-18 hardware will be installed in the access hole on the bottom side of the front cradle. All bolts need to point to the back of the vehicle (bolt head is towards the front). **NOTE:** Make sure you have the correct control arm on the correct side of the cradle. The front sway bar mounting tab will be towards the front of the vehicle (Figure 20). Torque the lower control arm bolts to 95 ft-lbs.

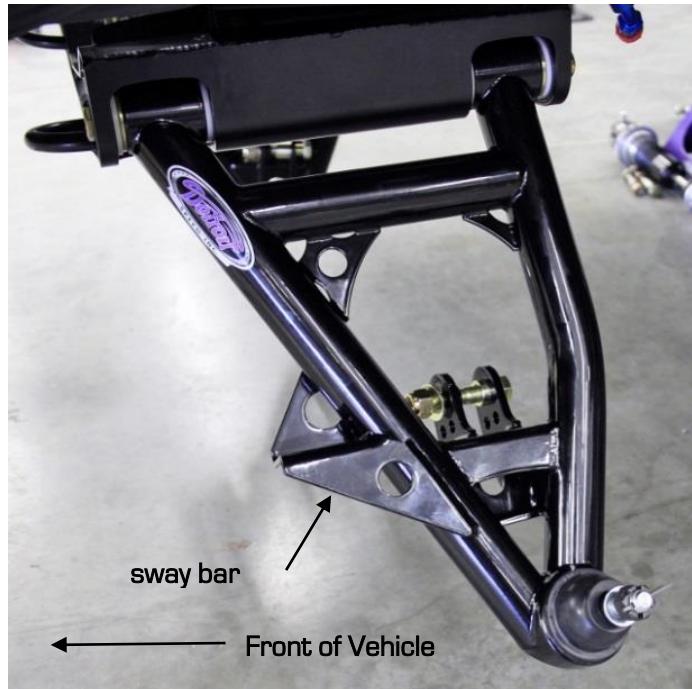

Figure 20 - Drive Side Lower Control Arm

22. Before the rack and pinion assembly is installed to the cradle you can center the rack on the bench before it is installed. Mark a line along the length of the input shaft. Turn the rack all the way to one side and mark the housing where the line on the input shaft lines up. Turn the rack all the way in the other direction and mark the housing where the line on the input shaft lines up. Turn the rack back in the opposite direction so that the line on the input shaft lands in between your two marks on the housing (Figure 21).



Figure 21 - Center the Rack and Pinion

23. Thread the grease fittings into the tie rod ends. Install the 9/16"-18 jam nuts onto each end of the tie rod threads on the rack and pinion. Apply anti-seize to the threads, then thread the outer tie rod ends onto the rack and pinion. When installing the tie rods, make sure they are equal distant on each side to center the steering. This measurement should be approximately 1" per side. Measure this from the end of the threads to the inside edge of the nut (Figure 22). Torque the tie rod end jam nuts to 45 ft-lbs.



Figure 22 - Install the Tie Rod Ends

24. Install the rack and pinion assembly into the front cradle mounts. Use the provided 1/2"-20 x 2-3/4"L hex head bolts with the 1-5/8" washers facing forward (i.e. the bolt head is towards the rear). Apply anti-seize to the bolts and install the provided 1/2"-20 Nylock nuts and washers (Figure 23). Torque to 85 ft-lbs. **CAUTION:** Now is a good time to mockup the steering coupler on the input shaft of the rack to make sure there is clearance between the coupler and the factory engine stand. You may need to notch the rearward flange on the engine stand or trim the coupler set screws to allow clearance to the coupler.



Figure 23 - Install Rack & Pinion

25. Install the Detroit Speed upper control arms to the factory upper control arm mounts. You can use either the factory upper control arm bolts that were removed in Step 2 or the provided 7/16"-14 x 2-1/4"L hex head bolts along with the provided Nylock nuts and washers. Use anti-seize on the threads of the bolts. You may need to drill out the mounting holes if you plan on using the 7/16" bolts. **NOTE:** Make sure you have the correct control arm on the correct side of the cradle. On the bottom side of the control arm gusset, there is a letter "L" stamped for the driver side and a letter "R" stamped for the passenger side. The Detroit Speed decal will also be on the front tube of the control arm (Figure 24).



Figure 24 - Driver Side Upper Control Arm

26. Before you tighten the bolts, install two of the provided 1/8" shims on each bolt between the cross shaft and the upper control arm mount (Figure 25). Torque the upper control arm bolts to 55 ft-lbs.



Figure 25 - Install 1/8" Shims



27. Next install the sway bar composite bushing into the sway bar bracket assembly (Figure 26). Lube the outside of the composite bushings with soapy water. The bushings may not push in completely by hand. Do not be concerned, as they are designed to be a very precise fit. With the bushing started in the bracket assembly, use a large diameter socket and a rubber hammer to seat the bushings at this time. Repeat this step for the other sway bar bracket assembly.



Figure 26 – Install Sway Bar Composite Bushings

28. Lube the inside of the composite bushings with the provided super grease and do your best to fill the interior bushing grooves. Clean the outside of the sway bar thoroughly with lacquer thinner to remove any foreign materials from the bar. Once the bar is clean, slide both sway bar bracket assemblies onto each end of the sway bar. **NOTE:** Make sure the flange of the composite bushings are facing each other.

29. Bolt the sway bar bracket assemblies to the factory sway bar mounts into the frame with the provided 5/16"-18 x 1"L flanged head hex bolts using medium strength blue Loctite 242 on the threads of the bolts (Figure 27). **NOTE:** The sway bar is not installed in the bushings in this picture. Torque bolts to 25 ft-lbs.



Figure 27 – Install Sway Bar Bracket Assembly

30.Center the bar in the crossmember. Measure the portion protruding from the bushings on each side and adjust accordingly until this measurement is the same on both sides, you should be around 1-3/4" on each side (Figure 28). Make sure to re-seat the bushings against the frame before measuring, as they can shift when you move the bar and throw off your measurements.



Figure 28 – Install Splined Sway Bar

31.Install the provided 1-1/4" sway Bar split lock collars next. Loosen both Allen screws in the lock collars using a 3/16" hex drive. Apply medium strength Blue Loctite 242 on the threads and position the clamp onto the sway Bar. With the heads of the bolts accessible from the bottom, torque the Allen screws to 14 ft-lbs. **NOTE:** Be sure that the groove in the clamp is installed so that it points to the center of the vehicle and that the two clamps match on either side (Figure 29).



Figure 29 – Install Sway Bar Split Lock Collars

32. Install the sway bar end links to the sway bar arms using the M12 x 1.75 flanged lock nut using an 18mm socket and 18mm wrench to hold the end link. The body of the end link should be on the outside of the sway bar arm (Figure 30). Apply high strength red Loctite 262 on the threads and torque to 45 ft-lbs.

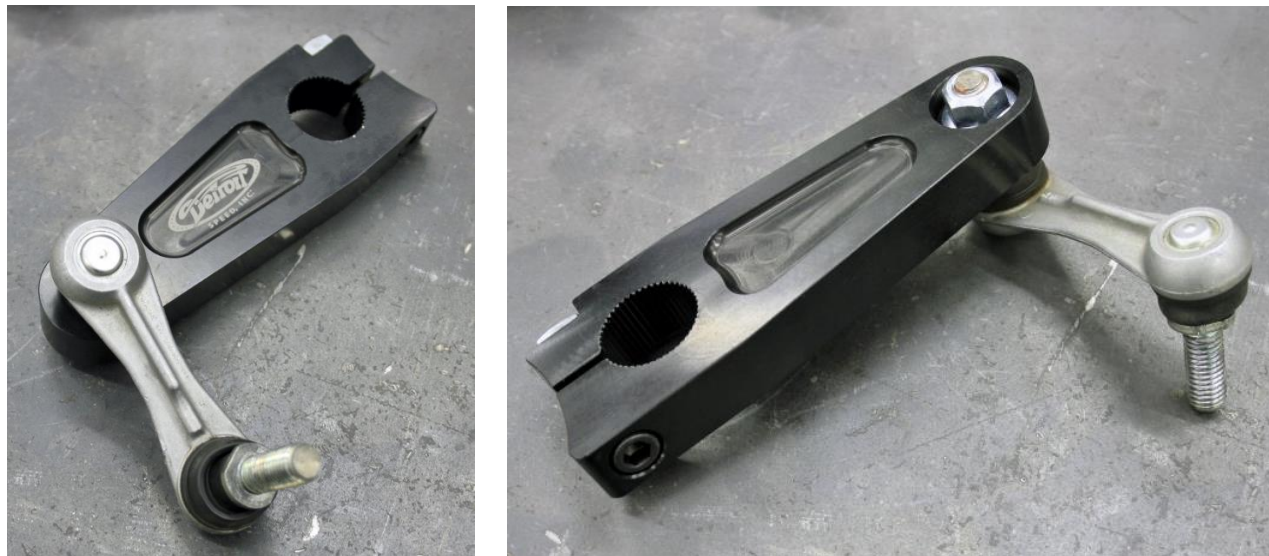

Figure 30 – Install Endlinks to the Sway Bar Arms

33. Install the sway bar arms to the sway bar. Make sure both arms are positioned the same on the splines and are even in relation to one another. When both arms are on the same splines, use the provided 3/8"-24 x 2"L socket head cap screws and bolt them in place with the 3/8" square nuts using a 5/16" hex drive. Apply medium strength blue Loctite 242 and install the bolts from the bottom so that the square nuts are on the top side of the sway bar arm (Figure 31). Torque the sway bar arm retaining bolts to 30 ft-lbs.



Figure 31 – Driver Side Sway Bar Arm

34. Next, install the spindle assemblies. Clean any grease from the upper and lower ball joint studs and the spindle holes with a clean rag and lacquer thinner. Install the spindle to the upper control arm first. Tighten the upper ball joint flanged lock nut and torque to 40 ft-lbs.
35. Place the spindle on the lower ball joint. Tighten the lower ball joint flanged lock nut and torque to 20 ft-lbs. plus 180° clockwise. **NOTE: It is critical to follow the torque procedure in the table on page 4 and to use High Strength Red Loctite 262 on the lower ball joint threads.**
36. Insert the outer tie rod ends into the steer arms. **NOTE:** Turn and position the stud so the cotter pin locates from front to rear to ease installation. Apply anti-seize to the threads and torque to 35 ft-lbs. making sure that the slotted nut lines up with the cotter pin hole. Install the cotter pin (Figure 32).



Figure 32- Install Tie Rod Ends to Steering Arms

37. Install the sway bar end links to the lower control arms. These must be installed on the lower control arms now as tightening the links later can be very difficult. Use the included M12 x 1.75 flange lock nuts (Figure 33). Apply high strength red Loctite 262 on the threads and torque to 45 ft-lbs.



Figure 33 - Install the Sway Bar Endlinks to the Lower Control Arms

38. Next, it is necessary to build each coilover shock and spring assembly before installing them into the frame.

39. Remove the upper spring seat from the retaining ring using a rubber hammer and moving it down off the upper shock mount (Figure 34). Remove the retaining ring from the upper shock mount and pass the upper spring seat over the upper shock mount (Figure 35).



Figure 34 – Removing the Upper Spring Seat



Figure 35 – Upper Spring Seat & Retaining Ring

40. Thread the spanner nut all the way to the bottom of the coilover shock and install the Torrington bearing set (Figure 36) on each shock by installing one thrust washer, followed by the roller bearing and then another thrust washer. DSE recommends using high pressure grease between the roller bearing and thrust washers.



Figure 36 – Torrington Bearing Set

41. Slide the coilover spring over the top of the upper shock mount. Install the upper spring seat back over the top of the upper shock mount and re-install the retaining ring back onto the upper shock mount. Press the upper spring seat up onto the retaining ring so it locks in place.

42. Before installing the shocks into the frame, make sure the upper mounting holes are clean and free of any powdercoat so the bolts and spacers slide into the mounts. Position the shaft side of the shock up through the lower control arm and into the fabricated upper shock mount. The Schrader valve on the shock body should be pointed to the center of the vehicle. **NOTE:** If you have adjustable shocks, the adjustment window should be pointing out towards the wheel.

43. Install the provided 3/4" OD x 1-1/4" L upper shock spacer onto the provided 1/2"-20 x 4" L hex head bolt. Install the bolt and spacer through the fabricated mount, through the shock eyelet and through the welded bushing on the mount. Make sure the bolt is facing to the rear (Bolt head is toward the front) **NOTE:** There are two shock bolt spacers, make sure the longer spacer goes on the upper shock mount. Apply anti-seize to the threads and install the provided 1/2"-20 Nylock nut and washer (Figure 37 on the next page). Torque to 60 ft-lbs.

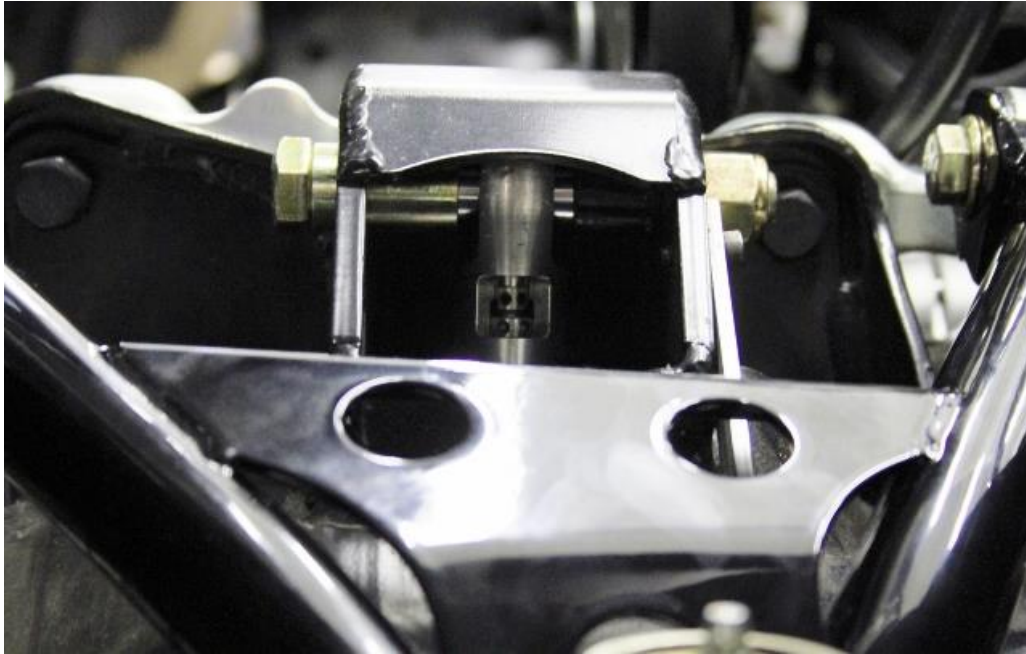

Figure 37 - Install the Upper Shock Bolt (Driver Side)

44. Before installing the shocks into the lower control arm mount, make sure the lower mounting holes are clean and free of any powdercoat so the bolts and spacers slide into the mounts. Position the shock body side of the shock to the lower mount.
45. Install the provided  $3/4" \times 5/8"$  L lower shock spacer through the provided  $1/2"-20 \times 2-1/2"$  L hex head bolt. Install the bolt and spacer through the lower mount, through the shock eyelet and through the welded bushing on the mount. Make sure the bolt is facing forward (Bolt head is toward the rear). **NOTE:** There are two shock bolt spacers, make sure the shorter spacer goes on the lower shock mount. Apply anti-seize to the threads and install the provided  $1/2"-20$  Nylock nuts and washers. (Figure 38) Torque to 60 ft-lbs.



Figure 38 - Install the Lower Shock Bolt Spacer (Driver Side)

46. The front suspension is assembled at this point. Figure 39 shows a completed installation. Double check to make sure that all installed components are tight and torqued correctly.



Figure 39 - Driver Side

47. After the front suspension is fully installed into the vehicle, the power steering hoses can be attached to the rack and pinion. Follow Figure 40 for the location of the pressure and return ports.

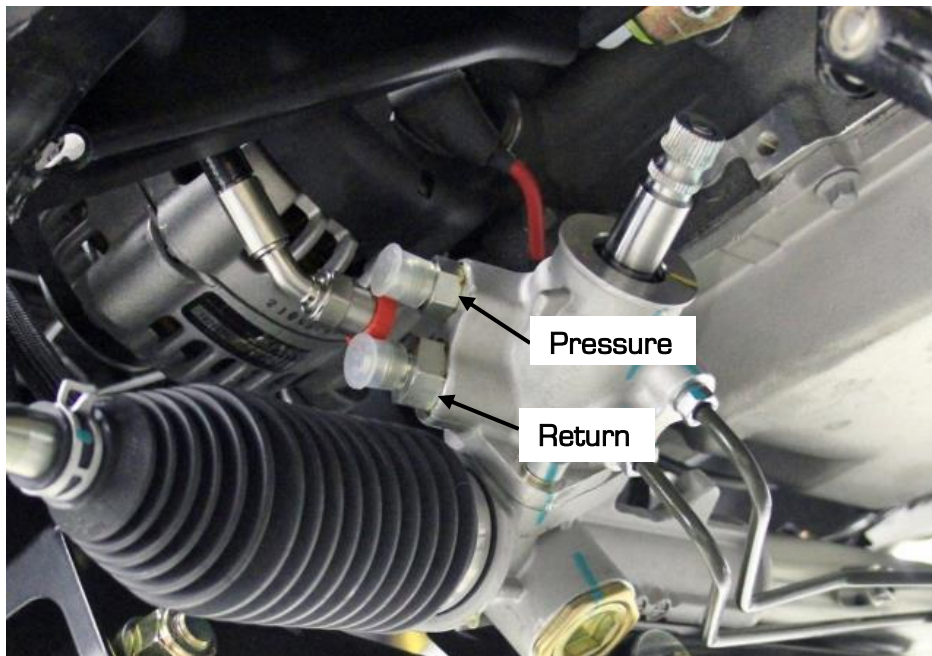

Figure 40 - Rack & Pinion Fittings

48. The front suspension is now assembled and installed (Figure 41 on the next page). **NOTE:** Be sure to lubricate all points on the front suspension with quality chassis grease.

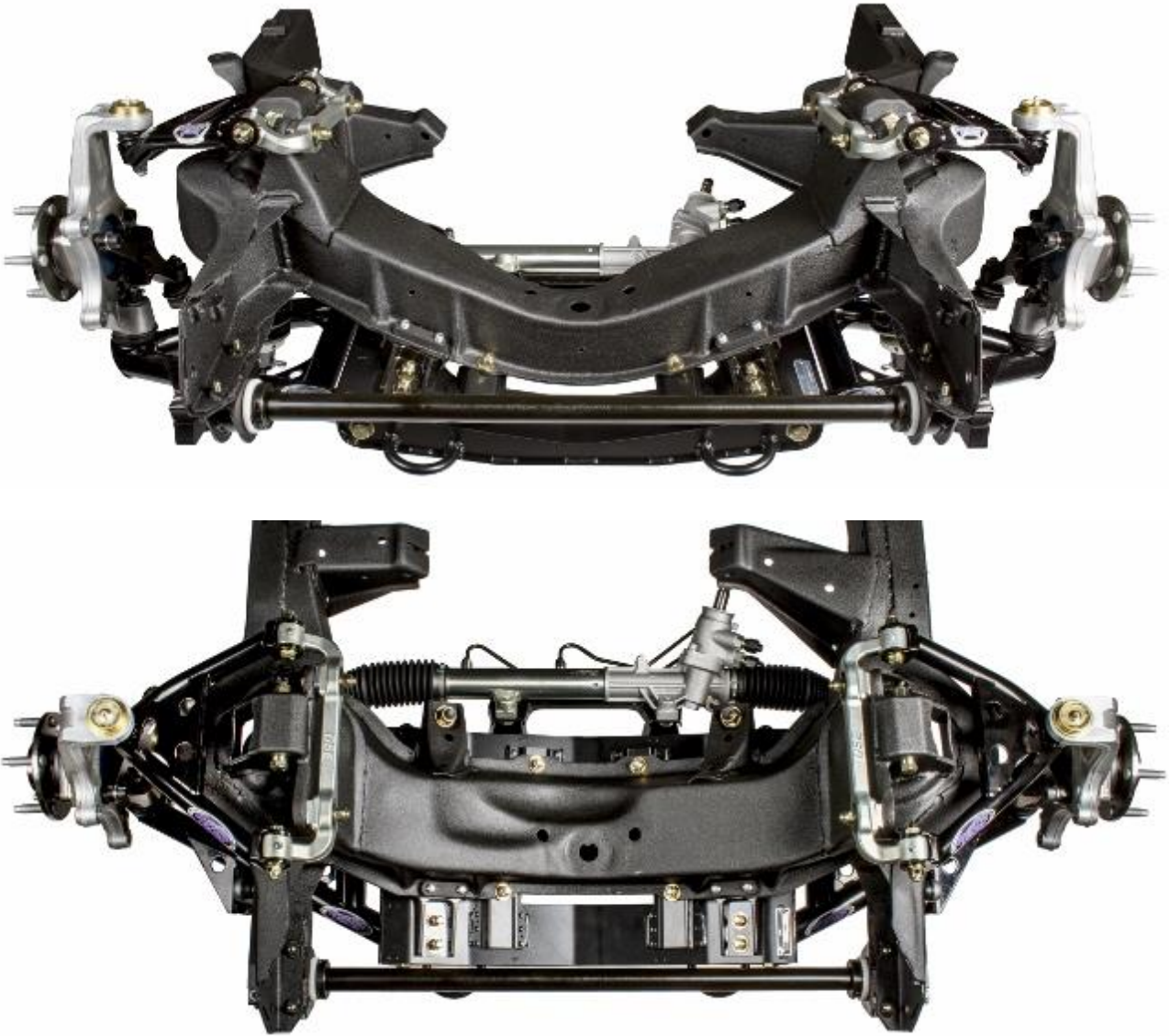

Figure 41 - Final Assembly

49. Now that all suspension components have been installed and the vehicle is assembled, it is time to set vehicle ride height. Before adjusting the ride height, DSE recommends cleaning the threads of the shock. Once the threads are clean, DSE recommends applying dry bicycle chain lube to the threads of the shock body before adjusting the spanner nut and compressing the coilover spring. Allow the chain lube to dry before adjusting the spanner nut. If you have the non-adjustable shocks, the spanner nut has a soft tip set screw that will need to be tightened before the vehicle is driven.

**NOTE:** Detroit Speed does include a Spanner Tool (P/N: 031060DS) to adjust the ride height however if you have the adjustable coilover shocks, Detroit Speed does offer an Adjustment Tool available as P/N: 031061DS if needed (Figure 42).



Figure 42 - DSE Spanner & Adjustment Tools



50. If the Single Adjustable, Double Adjustable or the Double Adjustable Remove Canister Coilover shocks were purchased as an upgrade, refer to the following information for adjustment procedures.

***Detroit Speed Single Adjustable Shock Applications***

To change from the recommended “Detroit Tuned” valving, adjustments can be made independently to the rebound setting. The rebound is controlled by the knob at the upper shock mount (Shock is mounted body side down). The knob rotates clockwise (+) to increase the damping and counterclockwise (-) to decrease the damping. Refer to Figure 43a.



**Figure 43a- Detroit Speed Single Adjustable Shock**

To return to the Detroit Speed recommended settings, turn the knob clockwise (+) to full damping. Once at full damping, turn counterclockwise (-) to reach the recommended settings. Refer to Figure 43b for the rebound settings.

Rebound (Shaft Knob)..... 15 Open (counterclockwise, -)

**Figure 43b - Detroit Speed Recommended Settings**

**Adjuster Operation**

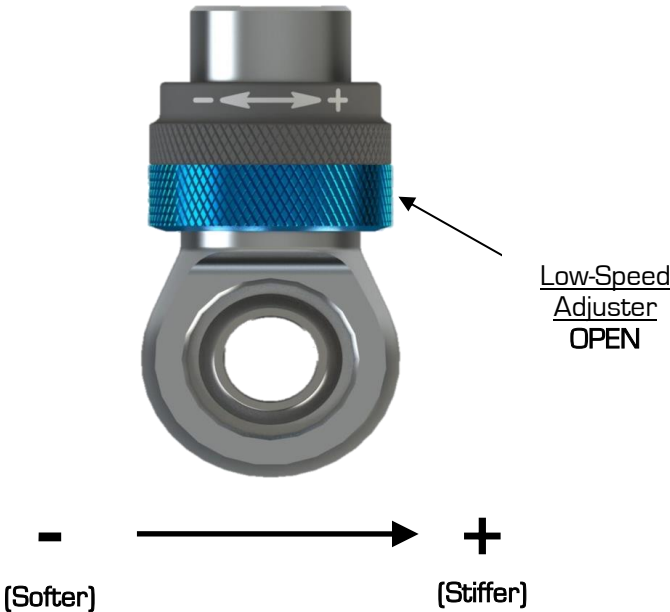

- **Adjuster (60-64 Clicks)**

The low-speed adjuster is a “clicker” style adjuster meaning that its adjustment is measured by detents located inside the blue adjuster knob. There are 16 clicks per 1 revolution of the knob. It uses a right-hand thread in its operation which means as you increase low-speed, the adjuster will move up on the eyelet. The recommended change for an adjustment is 8 clicks at a time. The low-speed adjuster’s reference position is **full stiff** (closed, or all the way up) and referred to -0 (-0 = full stiff, -64 = full soft).

- **Tuning Notes**

- **Racetrack**

- For more grip, soften the damping.
    - For increased platform control, stiffen the damping.

- **Street**

- For a more comfortable ride, soften the damping

**\*DO NOT FORCE KNOB WHEN IT STOPS TURNING, YOU MAY DAMAGE THE ADJUSTER AND INTERNAL HARDWARE**

*Detroit Speed Double Adjustable Shock Applications*

To change from the recommended “Detroit Tuned” valving, adjustments can be made independently to both the high and low speed settings. The rebound is controlled by the sweepers at the upper shock mount. The sweepers rotate clockwise (+) to increase the damping and counterclockwise (-) to decrease the damping. The sweepers can be seen in Figure 44a.



**Figure 44a – Detroit Speed Double Adjustable Shock**

When adjusting the low speed rebound start at full (+) position, when adjusting the high speed rebound start at full (-) position. To return to the Detroit Speed recommended settings turn the sweeper clockwise(+) to full damping for the low speed setting, and counterclockwise (-) to full damping for the high speed setting. Once at full damping, turn counterclockwise (-) for the low speed setting, and clockwise (+) for the high speed setting to reach the recommended settings. Refer to Figure 44b for recommended settings.

Low Speed Rebound (Sweeper)..... 15 sweeps (counterclockwise, -)  
 High Speed Rebound (Sweeper)..... 4 sweeps (clockwise, +)

**Figure 44b – Detroit Speed Recommended Settings**

***Detroit Speed Double Adjustable Shocks w/Remote Canisters***

To change from the recommended “Detroit Tuned” valving, adjustments can be made independently to both the high and low speed settings. The rebound is controlled by the sweepers at the upper shock mount. The sweepers rotate clockwise (+) to increase the damping and counterclockwise (-) to decrease the damping. Refer to Figure 45a.

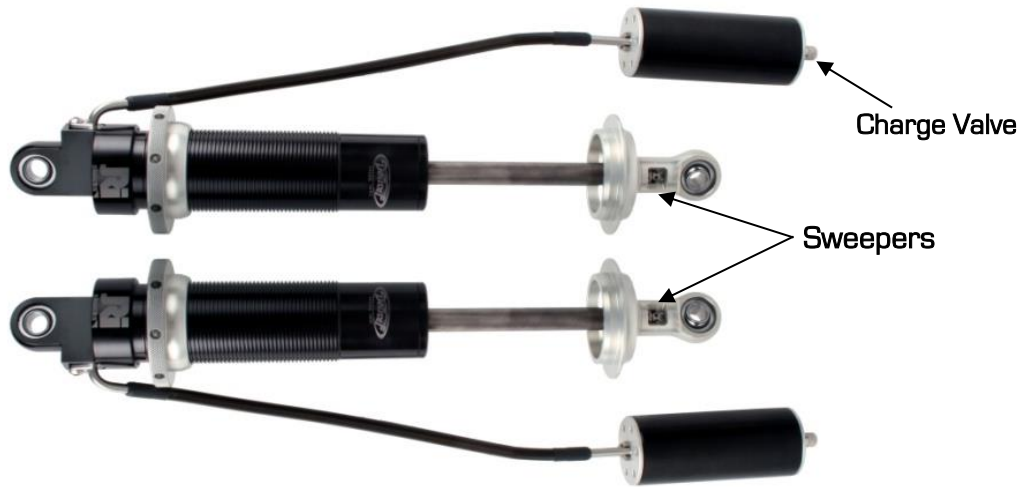

**Figure 45a – Detroit Speed Double Adjustable Shock w/Remote Canister**

When adjusting the low speed rebound start at full (+) position, when adjusting the high speed rebound start at full (-) position. To return to the Detroit Speed recommended settings turn the sweeper clockwise (+) to full damping for the low speed setting, and counterclockwise (-) to full damping for the high speed setting. Once at full damping, turn counterclockwise (-) for the low speed setting, and clockwise (+) for the high speed setting to reach the recommended settings. Refer to Figure 45b for recommended settings.

- Low Speed Rebound (Sweeper)..... 15 sweeps (counterclockwise, -)
- High Speed Rebound (Sweeper)..... 4 sweeps (clockwise, +)

**Figure 45b – Detroit Speed Recommended Settings**

**Adjuster Operation**

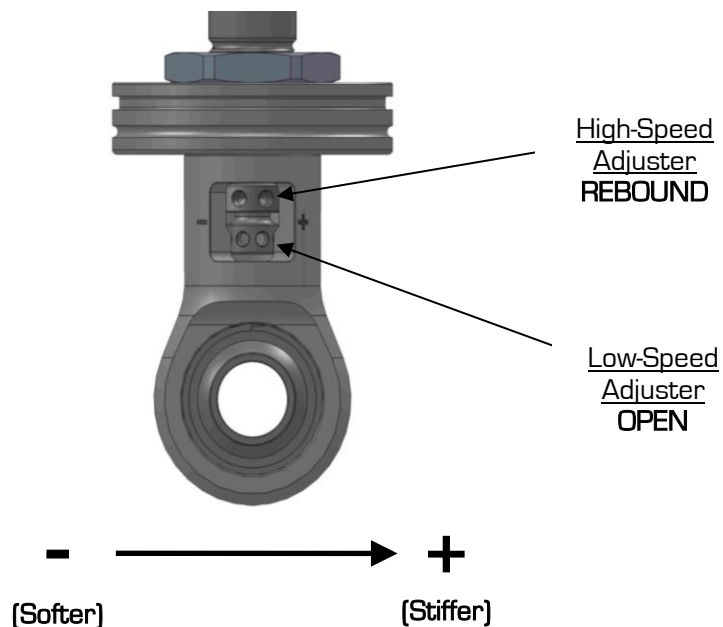

- **High-Speed Adjuster (12 Sweeps)**

The high-speed adjuster is a “sweep” style adjuster meaning that its adjustment is measured by the location of the adjuster in the eyelet window. It uses a left-hand thread in its operation which means; as you increase high-speed, the adjuster will move down in the window\*. The high-speed adjuster’s reference position is **full soft** and referred to as +0 (+0 = full soft, +12 = full stiff).

- **Low-Speed Adjuster (25 Clicks)**

The low-speed adjuster is a “clicker” style adjuster meaning that its adjustment is measured by detent grooves located inside the high-speed shaft. It uses a right-hand thread in its operation which means; as you increase low-speed, the adjuster will move up in the window. The low-speed adjuster’s reference position is **full stiff** and referred to -0 (-0 = full stiff, -25 = full soft).

*\*The low-speed adjustment does not change when adjusting the high-speed.*

To aid in the installation of the reservoirs, we also offer a set of Billet Aluminum Remote Canister Mounts. The canister mounts are available exclusively through DSE, P/N: 032102DS. They are shown in Figure 46.



**Figure 46 – Billet Aluminum Remote Canister Mounts**

Have a professional alignment completed following the specifications given in the chart on Page 2.

If you have any questions before or during the installation of this product please contact Detroit Speed at [tech@detroitsspeed.com](mailto:tech@detroitsspeed.com) or 704.662.3272

**Legal Disclaimer:** *Detroit Speed is not liable for personal, property, legal, or financial damages from the use or misuse of any product we sell. The purchaser is solely responsible for the safety and performance of these products. No warranty is expressed or implied.*