



Detroit Speed
Electric Headlight Door Kit
1963-67 Corvette
P/N: 122008

Thank you for your purchase of Detroit Speed's C2 Headlight Door Kit. This kit replaces the stock electric actuators on 1963-67 Corvettes. Not cutting, drilling, or any permanent modifications of vehicle is required to install this system. When installed, this kit will operate the headlight doors smoothly and reliably. The expensive, failure prone, and heavy original electric motors will no longer be a problem.

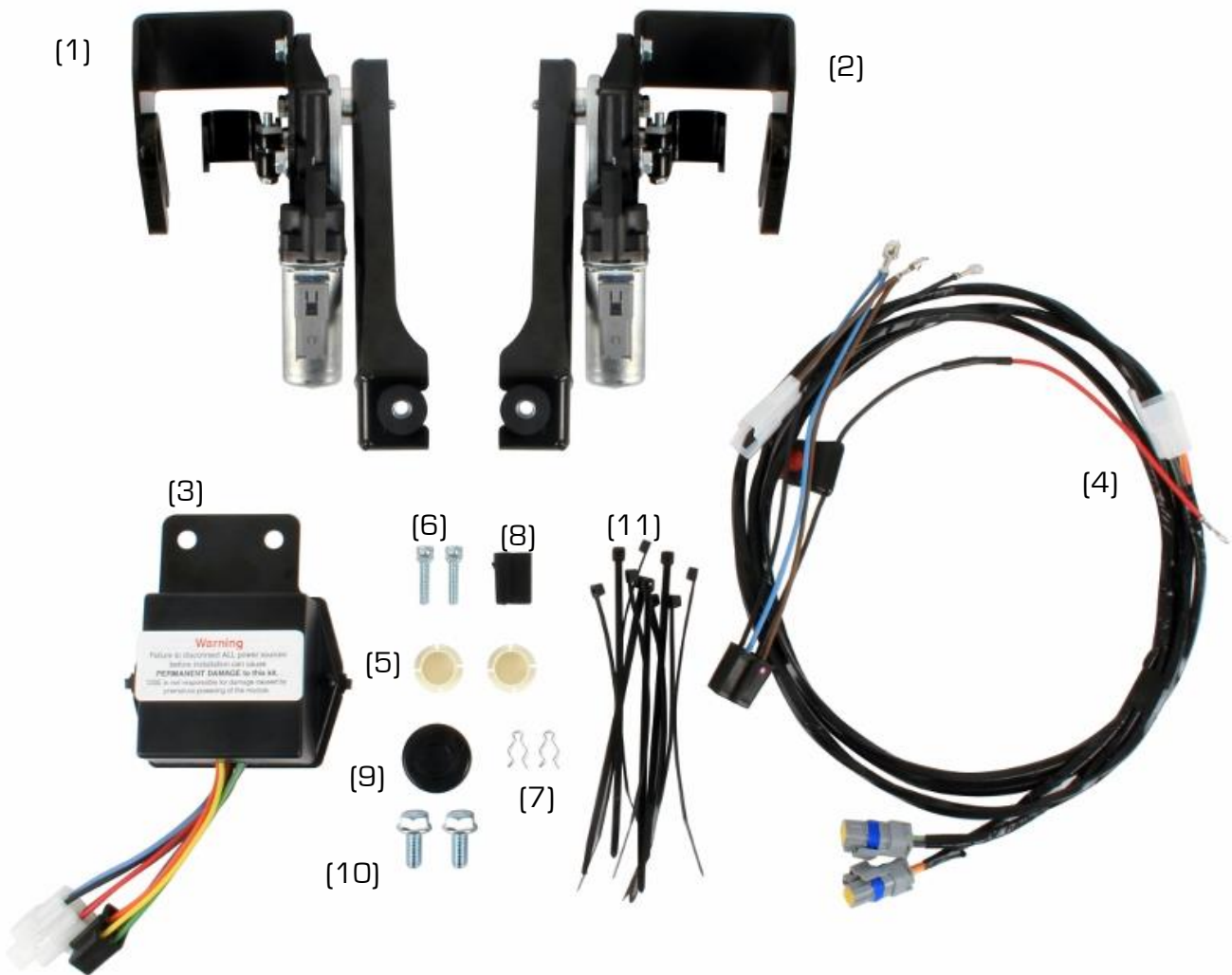

Figure 1

WARNING: The electric headlight kit will work best when the engine is running at idle. For everything to work the way it was designed, there must over 12 volts through the electrical system to ensure it works correctly. For more troubleshooting information, please see page 10 of this instruction.

Item	QTY	Description
1	1	LH Actuator w/ Brackets and Pitman Arm
2	1	RH Actuator w/ Brackets and Pitman Arm
3	1	Headlight Door Control Module w/ Bracket
4	1	Harness Assembly
5	2	Pivot Bushing
6	2	Rubber Mount Screw
7	2	Hairpin Clip
8	1	Packard Two-Terminal Connector
9	1	Rubber Grommet
10	2	5/16"-18 x 3/4"L Flange Head Hex Cap Screw
11	10	Nylon Wire Tie
12	1	Instructions

Many convenience features are integrated into this system. When the headlight switch is pulled to the "park" position, the park lamps illuminate. The headlights stay off and the headlight doors remain closed. When the switch is pulled to the "headlamps" position, the park lights stay on, the headlight doors open, and the headlamps illuminate. When the switch is pushed back to the "park" position, the headlamps turn off, but the headlamp doors remain open. This is useful to clean or service the headlamps since the doors will be open and the lenses cool. When switched to the "off" position, the park lights go out and the headlight doors close.

The separate switch that is used to raise and lower the headlight doors on the original system is no longer needed. The original headlight door warning/indicator lights will remain fully functional after the Detroit Speed Electric Headlight Door Kit is installed.

The module that is included with the Detroit Speed Electric Headlight Door Kit has a unique integrated failsafe protection mode. The module is designed to protect itself from damage due to a short circuit in your wiring system. If a short exists, the module will click continuously. This means a short has been detected and the module has entered into its failsafe mode. For the system to operate again, correction of the short circuit is required followed by resetting the module. To reset the module, remove the fuse from the main power wire for 10 seconds and then reinstall the fuse. If the clicking reoccurs, the short has not been repaired and needs further investigation.

The actuators are pressure sensitive to reduce the chance of personal injury or damage to vehicle in the event that something is caught in the door during operation. If the door comes in contact with a foreign object, it will stop its operation. The lights will need to be cycled on and off to reset the mechanism. **NOTE: The pitman arms on the actuators will not be able to be moved by hand as that could cause permanent damage to the actuators.**

Detroit Speed has gone to great lengths to provide you with the highest quality, best engineered product available with straightforward installation requiring minimal modification to your vehicle.

IMPORTANT: This kit is designed to work with properly installed and adjusted headlight doors. This system will not work correctly with doors that bind or do not have the stops adjusted properly. The doors must open and close without binding or resistance. Because the system is pressure sensitive, binding or sticking door assemblies will cause the actuators to stop prematurely. Detroit Speed suggests lubricating all pivot points.

Installation Instructions:

1. The new headlight kit will be connected to the existing 30 Amp circuit breaker for the original electric headlight door system that is located under the dash in the driver's side A-pillar/ kick panel area (Figure 2). This circuit breaker will need to be located and the original headlight door system power wire will need to be disconnected leaving the battery feed connected to the circuit breaker. There are several circuit breakers in this area that look the same so you will need to disconnect the circuit to determine which one is the correct circuit breaker. Disconnect the battery and look at the circuit breakers under the dash to try to determine from the wire routing which one is connected to the headlight door system.

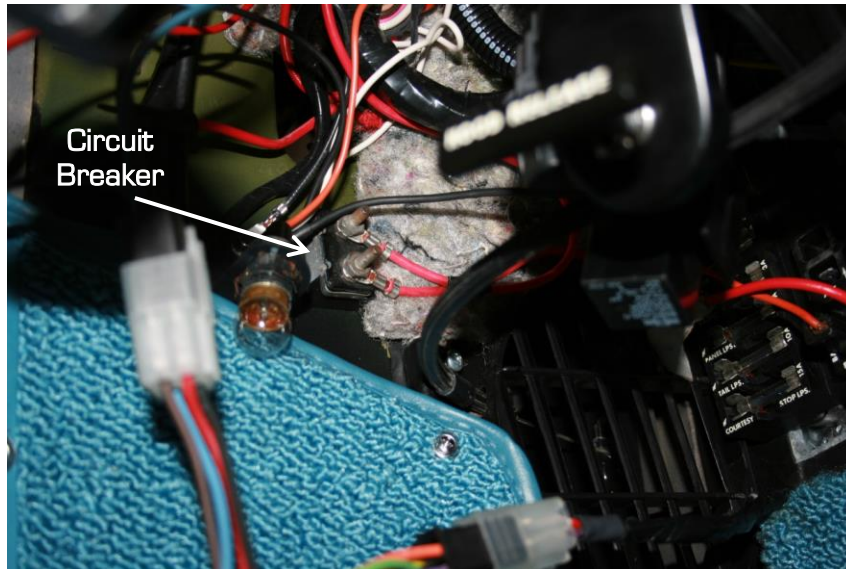

Figure 2 - Locate Circuit Breaker

2. Disconnect one of the wires from the circuit breaker and wrap the exposed terminal with electrical tape to keep it from accidentally shorting out to a ground source. Make sure that the poles on the circuit breaker cannot make a ground connection. Reconnect the battery and see if the original headlight door motors still operate. If they don't, proceed to step two. If they do, disconnect the battery and reconnect the removed terminal. Repeat this process on another circuit breaker until the correct circuit breaker is identified.
3. Once the original electric headlight door system circuit breaker is identified, the correct wire needs to be disconnected. The power supply and circuit feed wires on the breaker look the same so use a test light to determine if the correct wire was disconnected. When the correct wire is disconnected there should be power on both poles of the disconnected circuit breaker and no power on the disconnected wire. If you have the right wire disconnected, proceed to step three. If there is power on the disconnected wire and no power on the circuit breaker poles, the wrong wire is disconnected. Disconnect the battery, reconnect the removed wire, and disconnect the other wire from the circuit breaker. Reconnect the battery and retest.
4. The new system will connect to the pole on the circuit breaker where the original electric headlight door system circuit feed wire was disconnected in a later step. Tape up or shrink wrap the exposed terminal from the original wiring harness that was removed and tie the wire up out of the way. Disconnect the battery.
5. While it is not required, it is highly recommended to remove the hood for this installation. With the hood in place, access is extremely limited to remove the OEM motors, to install the new Detroit Speed motors, and to route the new wiring harness. Have someone assist you to carefully remove the hood from the vehicle taking care not to damage the paint.

6. Disconnect the original headlight motor wiring connectors, this will consist of one two-wire plug (Figure 3 Item A) and a separate ground wire (B) attached to the motor housing. Remove the motor support bracket rubber mount screws (C) that are located in the header panel. Remove the hairpin retainer clips (D) from the motor support studs. Turn the knurled knob (E) on the inboard side of the motors until the gear seems to turn freely, this will remove any preload from the motors. Remove the motor assemblies by sliding them off the pivot shafts towards the center of the car. It may be necessary to gently wiggle the motor assemblies to release tension between the motors and the pivot shafts.

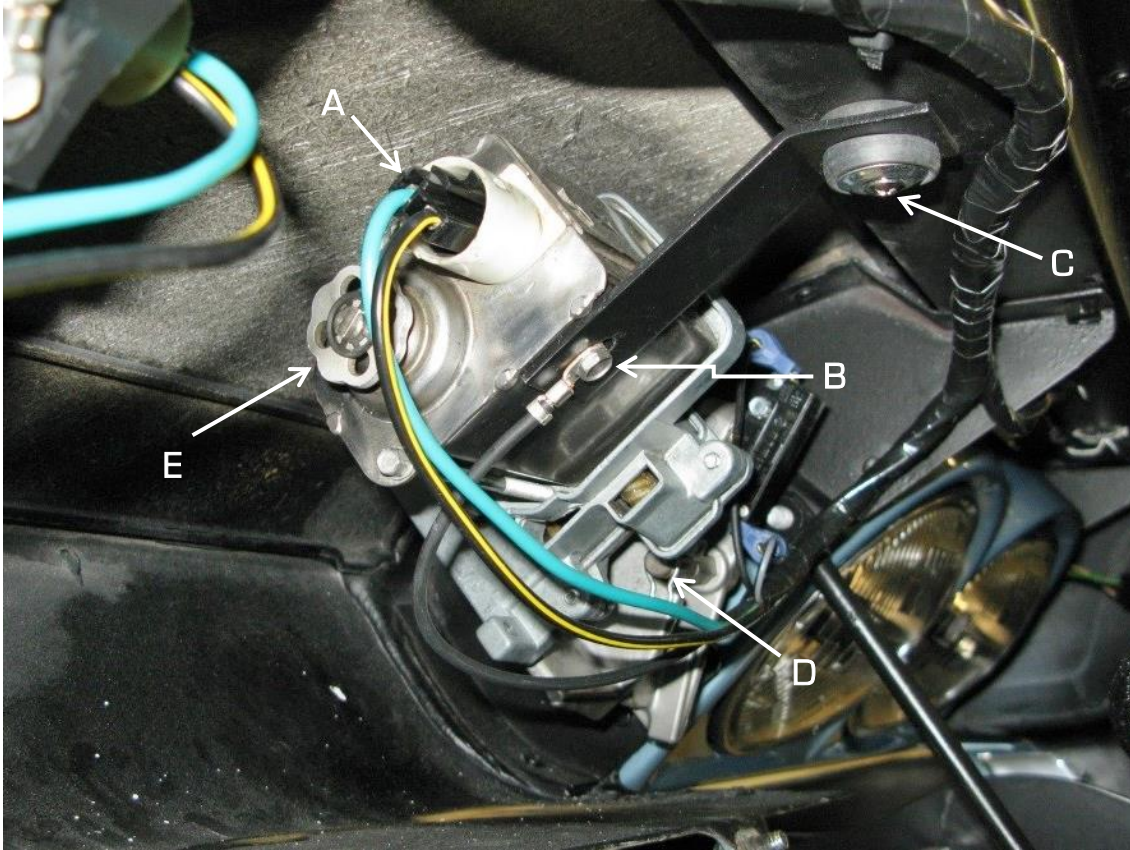

Figure 3 - Remove OEM Motor

7. With the motor assemblies removed, ensure that the plastic bushings that are located between the motor brackets and the headlamp door pivot shafts (the same bushing that is supplied in the kit (identified as item 5 in Figure 1) are in the brackets. If they did not stay in the motor brackets when removed, remove them from the headlight door pivot shafts or they will interfere with the installation of the new motors.
8. Route the headlight motor connector side of the new headlight harness from inside the vehicle under the dash, through the firewall using an existing hole if possible. Otherwise, you will need to drill a 1-1/8" diameter hole near the firewall bulkhead using a Uni-bit or drill bit to allow the headlight actuator connectors to pass through the firewall. **NOTE:** The carpet may need to be pulled back slightly to gain access.
9. Use the included firewall grommet to protect the wiring. Route the wires along the driver side inner fender well along the stock wiring and around the front of the core support toward the front of the vehicle.
10. Identify the driver's side actuator assembly (Item 1) and the passenger's side actuator assembly (Item 2) from Figure 1. Install a pivot bushing (Item 5) into the mounting bore of both actuator assemblies (Figure 4 on the next page).

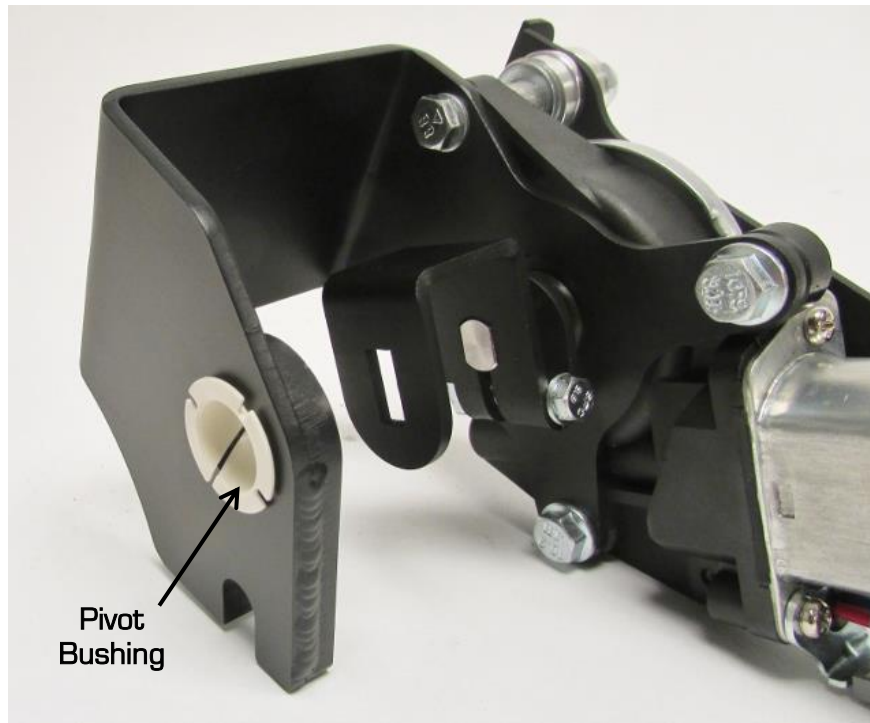

Figure 4 – Install Pivot Bushing

11. Place both actuator assemblies at the front of the vehicle by the headlight doors. Connect the driver's side connector from the headlight harness with the orange and yellow wires into the driver's side actuator. Connect the passenger's side connector with the purple and green wires into the passenger's side actuator.
12. Install the assembly onto the driver's side headlight door pivot shaft. Move the headlight door by hand until the rectangular part of the shaft can be inserted into the rectangular hole in the motor pitman arm. The headlight motors are shipped with the pitman arm in a certain position so that the headlight doors can be connected to the actuator in between the full open and full closed position of the headlight doors. **NOTE: Do not attempt to move the pitman arms on the actuators by hand as this could cause permanent damage to the actuators.** Line up the slot in the motor bracket with the hairpin clip shaft and slide the actuator assembly in place. Install a hairpin clip (Item 7) on the shaft and a rubber mount screw (Item 6) into the rubber mount, attaching it in the same location as the original motor (Figure 5). Repeat this procedure to install the passenger's side actuator assembly (Item 2).

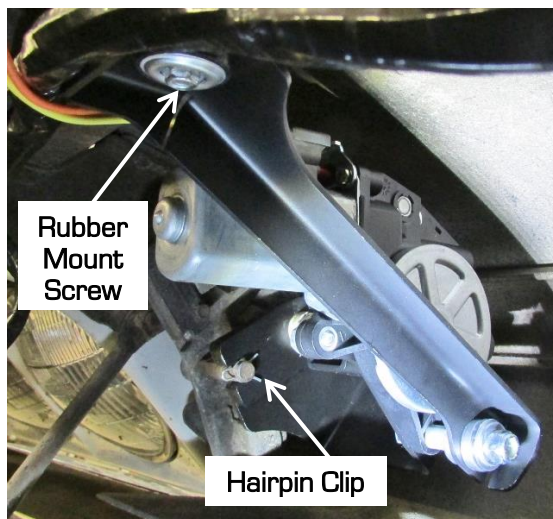

Figure 5 – Install Motor Assembly

13. Tighten the rubber mount screws to 20 in-lbs. There are spherical washers on the bolts that attach the actuator brackets to the support brackets that contain the rubber mounts which will compensate for any misalignment between the components. Allow the brackets to “float” in place and tighten the 1/4”-28 bolts to 80 in-lbs. (Figure 6).



Figure 6 – Tighten Support Bracket

14. Remove the headlight switch knob by pulling it out of the switch while holding down the release button on the top of the switch behind the dash. Remove the headlight switch retaining nut using a large screwdriver or other suitable tool. Drop the headlight switch down from behind the dash and unplug the switch connector.
15. For 1963 applications, see Figure 7. For 1964 to early 1965 applications, see Figure 8. For late 1965 to 1966 applications, see Figure 9 and for 1967 applications, see Figure 10 on the next page.
16. Locate the light blue wire or black with a light blue stripe wire as seen in Figures 6-9. Remove the terminal from the connector using a terminal removal tool or a small flat blade screwdriver. The blue/black with a light blue stripe wire is the 12 volt headlamp feed. Insert the terminal of the blue wire on the new headlight harness into the headlight connector location where the original blue/black with a light blue stripe wire was removed. **NOTE:** For 1964-67 applications, the instrument panel dark green wire can also be used for a power wire.
17. Locate the brown wire on 1964-67 models or the black wire on 1963 models as shown in Figures 6-9. This wire connects to the rear park/tail lamps. This wire connects to the rear park/tail lamps. Since the original wiring configuration for 1963-67 Corvettes did not illuminate the front park lamps when the headlights are on, the controller must be connected to the rear park lamps in order to cycle properly. Over the years many of these cars have been modified where owners have connected the front park lamp feed to a different terminal on the switch to keep the front park lamps on when the headlights are illuminated. There may be more than one brown or black wire in the connector so be sure to remove the correct one. Remove the terminal from the headlight switch connector using a terminal removal tool or a small flat blade screwdriver. Insert the terminal of the brown wire on the new headlight harness into the headlight connector location where the original rear park/tail lamp wire was removed.

Remove existing black or brown wire terminal and install brown wire terminal from new harness

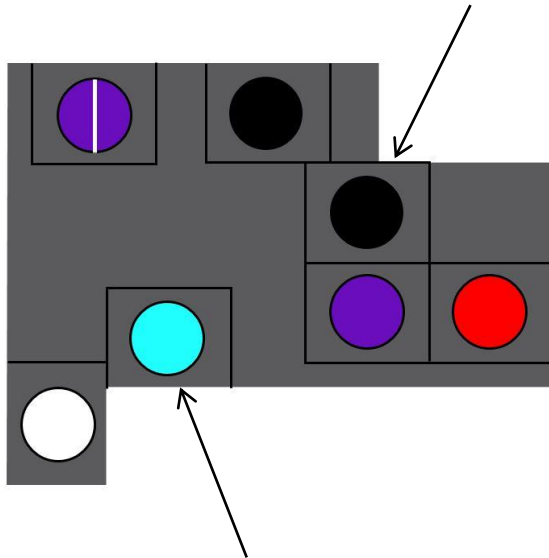

Remove existing light blue or black with light blue wire terminal and install light blue wire terminal from new harness

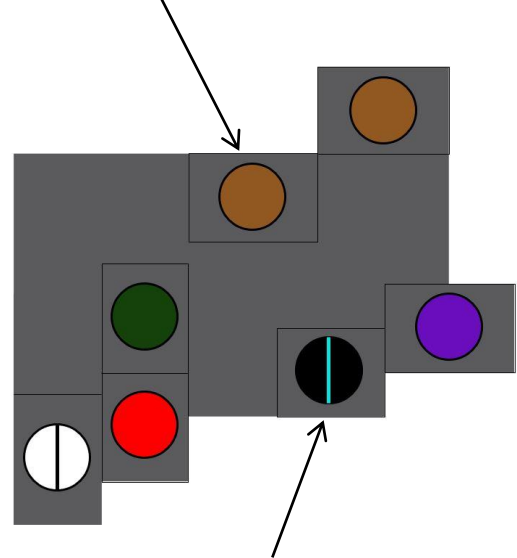
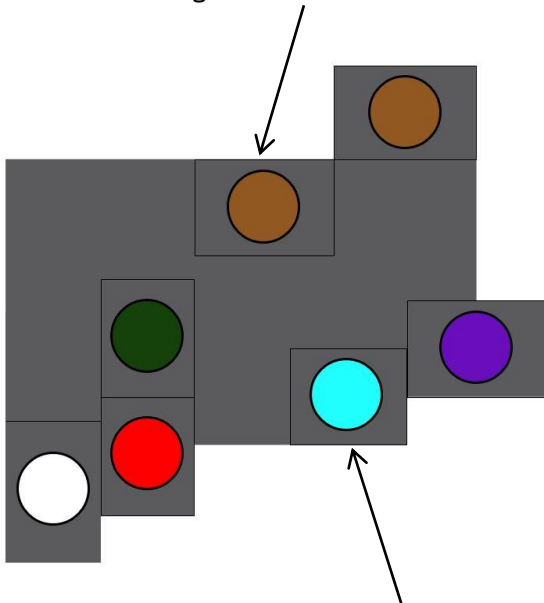

Figure 7 - End View (Harness Side)
1963 Corvette

Figure 8 - End View (Harness Side)
1964 to Early 1965 Corvette

Remove existing brown wire terminal and install brown wire terminal from new harness



Remove existing light blue wire terminal and install light blue wire terminal from new harness

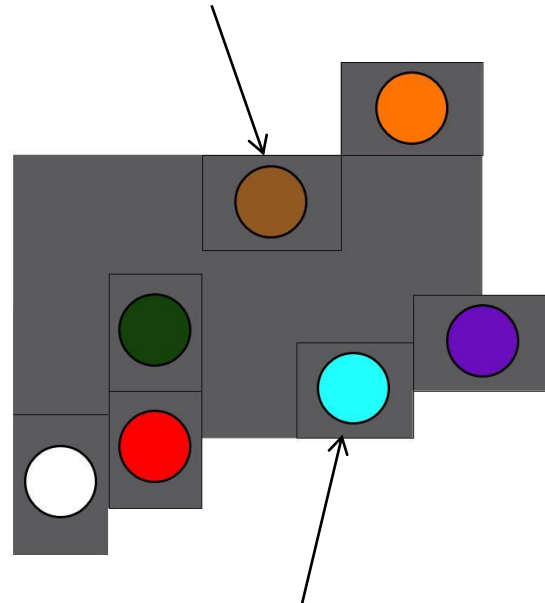

Figure 9 - End View (Harness Side)
Late 1965 to 1966 Corvette

Figure 10 - End View (Harness Side)
1967 Corvette

NOTE: You can also pull your power from the dimmer or high beam switch. As long as your dimmer switch is good, this is another option to pull power to the headlight kit from the headlight switch (Figure 11 on the next page).

HEADLIGHT DIAGRAM

1963-67 Corvette

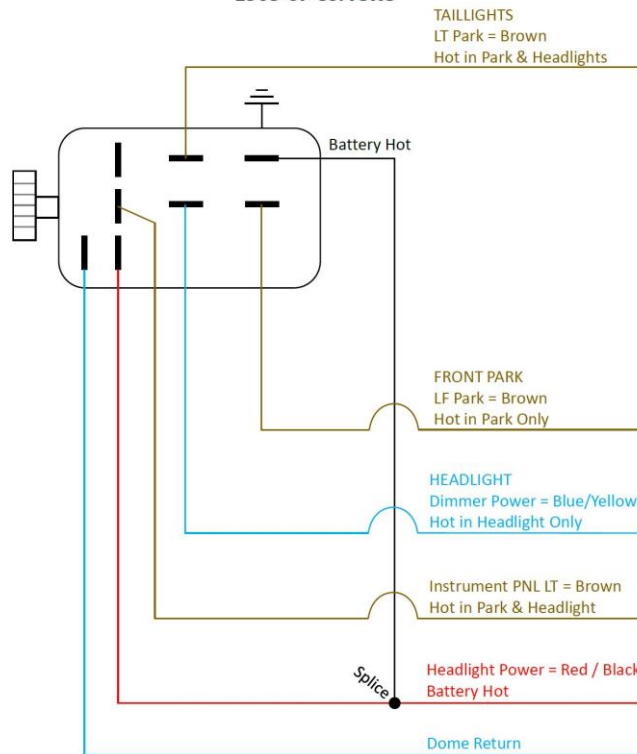

NOTE:

- LT Park would be your brown
- LF Park would have to be looped to LT Park for front park to be on with headlights
- Dimmer power would be your blue wire
- NAPA Part # HL6554 is most common aftermarket switch to use in this model

Figure 11 – Headlight Diagram

NOTE: Depending on your application, the wire colors on your connector may not match the ones above. The spades on the headlight switch will have the same function on the switch even though the wire color may not match.

NOTE: Make sure that the LT Park and the LF Park terminals are looped together so that the park lights will be on with the headlights.

18. Install the wire terminals which were just removed from the original headlight harness connector into the included black two terminal female Packard connector (Item 8) cavities as shown in Figure 12. Plug this connector into the white two-terminal connector on the new harness. Make sure that the wire colors correspond with each other (light blue or black with light blue stripe to light blue, brown or black to brown).

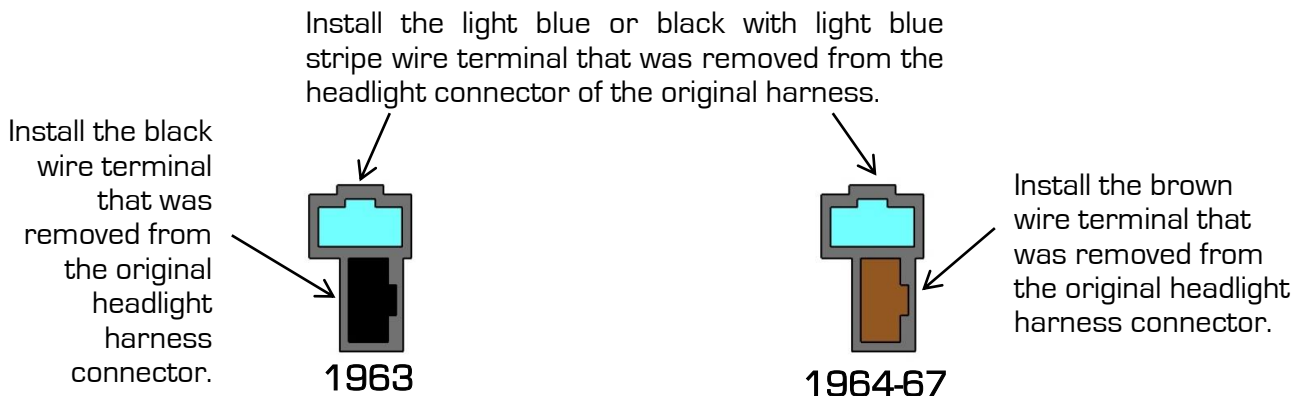

Figure 12 - End View (Harness Side)

19. Plug the headlight switch connector back into the headlight switch. Do not install the switch back into the dash at this time. Install the headlight knob back into the unmounted switch.
20. Attach a 12V constant power source to the module by installing the red wire with the ring terminal on the new harness to the pole on the original headlight door system circuit breaker where the original headlight door system feed wire was disconnected in steps one and two. Make sure the 10-amp fuse is installed in between the power source and the module.
21. Connect the black wire with the ring terminal on the new headlight harness to a suitable ground. Some vehicles have an existing ground connection behind the driver's side kick panel. Make sure to remove any paint or corrosion to ensure that a good ground connection is made.
22. Connect the new headlight harness to the module. Plug the female connector with the red, blue, black, and brown wires labeled "TO HDL SWITCH" to the black connector on the headlight switch side of the harness. Plug the male connector with the orange, yellow, green, and purple wires labeled "TO HDL MOTORS" to the clear connector on the motor side of the harness (Figure 13). Verify this by checking that the wire colors on the harness match the wire colors on the module pigtails.



Figure 13 - Headlight Module Pigtails

23. Before powering the system, double-check all of the wiring connections for continuity using a multi-meter. Incorrect wiring can cause serious damage to the system.
24. Reconnect the battery. The system will cycle at this point and the doors should be in the closed position.
25. Once the system has cycled, check the operation of the system by turning the headlamps on and off. If the system is operating correctly proceed to the next step. If not, check all of your wiring connections again and refer to the troubleshooting guide at the end of these instructions.
NOTE: If you are still having problems, one solution is to bypass the fuse block and run the power and ground wires directly to the battery.
26. Once the operation of the system has been verified, disconnect the battery again.
27. Remove the headlight switch knob and reinstall the headlight switch into the dash. Install the headlight switch retaining nut and install the headlight switch knob.

28. The Detroit Speed Electric Headlight Door Kit Control Module bracket is designed to be mounted to the two threaded holes on the far-left side of the dash just above the driver's side kick panel (Figure 14). If the vehicle has the hood release cable bracket mounted in these holes, remove the two bolts that hold the hood release cable bracket. **NOTE:** If you also have the Detroit Speed wiper kit installed, you can mount both control modules to the same mounting plate. Mount both modules back-to-back on the mounting plate using the provided 8-32 hardware (Figure 15). Do not overtighten.

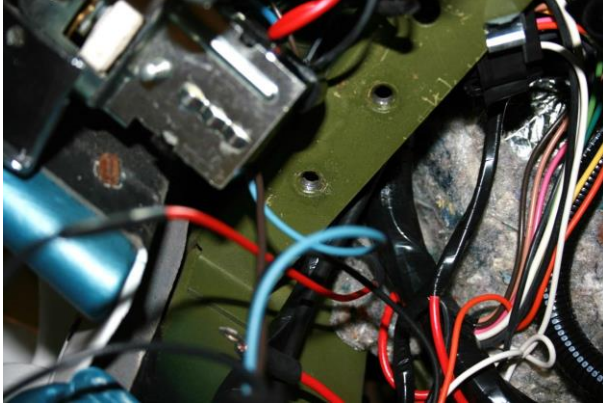

Figure 14 - Locate Module under Dash



Figure 15 - Headlight & Wiper Modules

29. Install the headlight door control module mounting bracket under the hood release cable bracket and reinstall the bolts (Figure 16). If the hood release cable is not mounted through these holes, use the included 5/16"-18 x 3/4" L Flange Head Hex Cap Screws to mount the module in the position.

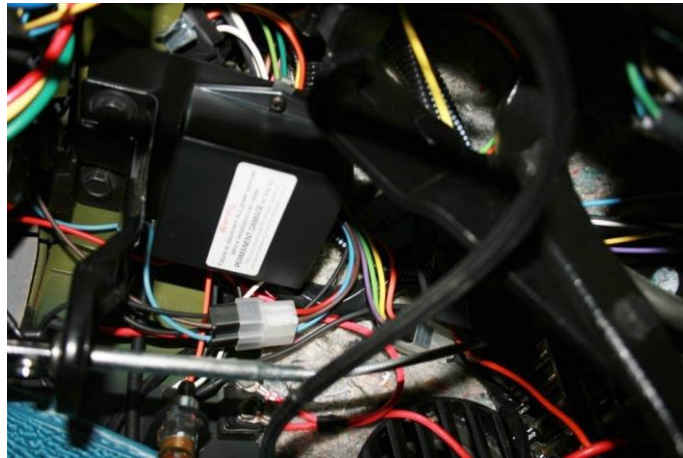

Figure 16 - Mount Control Module

30. Secure the new wiring harness under the dash, in the engine compartment, and at the front of the vehicle with the included tie straps. Tie up the old headlight motor wiring harness at the front of the vehicle.

31. Reconnect the battery and install the hood. Enjoy your new Detroit Speed Electric Headlight Door Kit!

If you have any questions before or during the installation of this product, please contact Detroit Speed at tech@detroitsspeed.com or 704.662.3272

Legal Disclaimer: *Detroit Speed is not liable for personal, property, legal, or financial damages from the use or misuse of any product we sell. The purchaser is solely responsible for the safety and performance of these products. No warranty is expressed or implied.*

Headlight Troubleshooting

After all connections are made, connect the battery. The doors should go through a "power up" cycle. During this cycle, the doors will open partially, and then close. Anytime the current source to the module is disconnected and reconnected, the doors will go through the "power up" cycle. The module features a failsafe protection to protect the module from being shorted out. If a short exists, the module will beep and is followed by a series of clicks. This means a short has been detected and the module has entered into its fail safe mode. For the system to operate again, correction of the short circuit is required followed by resetting the module. To reset the module, remove the fuse from the main power wire for 10 seconds and then reinstall the fuse. If the clicking reoccurs, the short has not been repaired and needs further investigation. The following chart shows the expected voltages at the module input during typical operation. Use this to troubleshoot the wiring installation and headlight switch operation.

Headlight Switch Position	Wire Color				Door Operation	Light Operation
	Red	Black	Brown	Blue		
Off	+ 12 V	Ground (- 12V)	0V	0V	None	None
Park	+ 12 V	Ground (- 12V)	12 V	0V	None	Park
Headlight	+ 12 V	Ground (- 12V)	12 V	12 V	Door Opens	Headlights*
Park (after headlights on)	+ 12 V	Ground (- 12V)	12V	0V	None (Door remains open w/headlights off)	Park
Off	+ 12 V	Ground (- 12V)	0V	0V	Door Closes	None

* Park lights will turn off when headlights are on.

Condition	Cause
Module clicks continuously.	The module has entered into its failsafe mode. The module enters into this mode when it detects a short in the system. To correct, determine and repair the short that exists in the system. To return the module to its normal function, remove the 10 amp fuse for 10 seconds and reinstall the fuse. The system should go through its "power up" cycle. If it does not or the clicking continues, a short still exists in the vehicles electrical system and requires further investigation.
Doors only open or close partially.	Most issues with door operation are due to headlight door assemblies that have too much resistance, binding, or are out of adjustment. If the actuators operate as described, intermittent problems are most likely due to doors that have too much resistance opening and/or closing.
One door opens faster/slower than the other.	One door has more/less resistance than the other. Lubricate pivot points and adjust the tension of fasteners at pivot points.
Doors do not operate at all.	Make sure the battery voltage is over 12 V. A low battery condition can result in inoperable doors. Check all connections. Make sure fuse is not blown and doors are not binding.
One or both doors close when the headlight switch is turned on. Door(s) open when the headlight switch is turned off.	On the driver's side, make sure the orange wire is inserted into cavity "1" and the yellow wire into cavity "2" of the supplied connector body. The purple wire should be inserted into cavity "2" and the green wire into cavity "1" of the supplied connector body for the passenger side. If the wires are terminated properly and the problem still exists, reversing the wires on the offending actuator(s) will solve the problem.
Doors do not go through "power up" cycle.	Check voltages at red, black, blue, and brown wires as described in above chart. If voltages are consistent with the chart, try disconnecting and reconnecting the red wire. If the doors do not operate or do not attempt to operate at this point, double check that the actuator harness is plugged into the module and the actuators. Check continuity between the actuator wires at the module pigtail and at the actuator connector.

Module Connector Pin-out (back of connector)

Red Wire	Constant 12V Battery Voltage
Black Wire	Ground
Brown Wire	Park Lamp Feed
Blue Wire	Headlight Feed
Orange Wire	LH Actuator +
Yellow Wire	LH Actuator -
Green Wire	RH Actuator +
Purple Wire	RH Actuator -

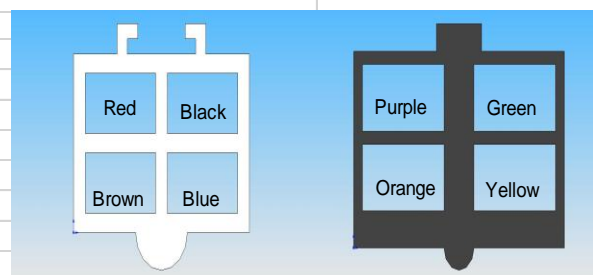

*looking from back side of connector

*If none of these suggestions solve your particular issue, please call Detroit Speed at (704) 662-3272.