

**Detroit Speed**  
**Hydroformed Front Subframe**  
1967-1981 Camaro/Firebird & 1968-1974 Nova  
P/N: 032004DS, 032004-SDS, 032004-DDS, 032004-RDS, 032005DS, 032005-SDS,  
032005-DDS, 032005-RDS, 032017DS, 032017-SDS, 032017-DDS, 032017-RDS,  
032018DS, 032018-SDS, 032018-DDS & 032018-RDS

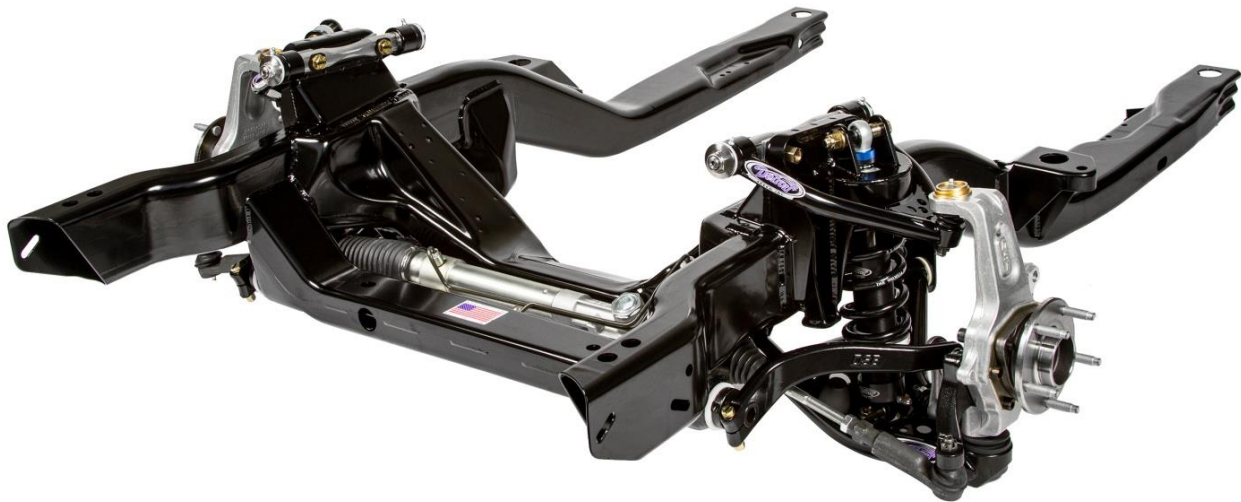

Congratulations on your purchase of a hydroformed front subframe from Detroit Speed. This front subframe is a bolt in replacement for the original stock front subframe and greatly improves handling and ride quality by utilizing Detroit Speed's unique suspension geometry. It is the only front subframe in the aftermarket industry with hydroformed frame rails. The hydroformed frame rails feature high strength and stiffness, decreased weight, and precise quality and repeatability. Hydroforming preserves the steel's strength and stiffness because it is performed at low temperature, unlike traditional high temperature processes which decrease material strength.

The Detroit Speed front subframe has been designed, engineered, and developed for the road and track. This front subframe blends the benefits of current OEM technology and aftermarket performance into one product. The Detroit Speed front subframe has the following features:

- Hydroformed frame rails and stamped cross members
- Optimized suspension and steering geometry
- Ability to accommodate small and big block Chevrolet engines as well as LS1, LS2, and LS7 engines
- Fits within stock inner fenders on a 1969 Camaro without modifications. 1967-1968 Camaros may require modifications to the inner fenders.
- Aluminum body coilover shocks with "Detroit Tuned" valving
- Splined sway bar
- Power rack and pinion steering

Accessory Components – Detroit Speed Front Subframe	
Brakes	DSE has Baer and Wilwood brake packages for our front frame. Any C6 Corvette brake application will work with our front frame.
Body Mounts	DSE stock height body mounts or any stock type body mount
Subframe Connectors	Most connectors available for the stock subframe will fit
Rack & Pinion Fittings	Return (low): 5/8" – 18 - Pressure (high): 9/16" - 18 Fittings to adapt to -6 AN and complete hose kits are available from DSE
Rack & Pinion Input Shaft	3/4"-36, Complete kits available from DSE
Transmission Crossmember	Stock or aftermarket cross members designed to fit a stock subframe (1967-69 Camaro/Firebird & 1968-74 Nova) Stock cross members will have to be modified to fit 1970-81 Camaro/Firebird
Z-Bar Bracket	Bolt-on bracket available for stock clutch linkage for 1967-69 Camaro/Firebird & 1968-74 Nova. See Page 4.
Parking Brake Cable	Stock routing and mounting for 1967-69 Camaro/Firebird & 1968-74 Nova
Wheel Stud Kit (Optional)	ARP 100-7708 – M12-1.5 x 2.5" L GM Wheel Stud Kit

Wheel and Tire Fitment					
1967-68 Camaro/Firebird			1969-81 Camaro/Firebird		
Wheel Size	Wheel Backspacing	Tire Size	Wheel Size	Wheel Backspacing	Tire Size
17" x 8.0" *	5.125"	245/45ZR17	17" x 8.0" *	4.875"	245/45ZR17
18" x 8.0"	5.125"	245/40ZR18	18" x 8.0"	4.875"	245/40ZR18
18 x 8.5"	5.625"	245/40ZR18	18 x 8.5"	5.125"	245/40ZR18
18" x 9.0"	6.000"	255/35ZR18	18" x 9.0"	5.375"	255/35ZR18
18" x 9.5"	Not Recommended		18" x 9.5"	5.875"	255/35ZR18
18" x 10"	Not Recommended		18" x 10"	6.000"	275/35ZR18

Wheel and Tire Fitment		
1968-74 Nova		
Wheel Size	Wheel Backspacing	Tire Size
17" x 8.0" *	5.125"	245/45ZR17
18" x 8.0"	5.125"	245/40ZR18
18 x 8.5"	5.625"	245/40ZR18
18" x 9.0"	6.000"	255/35ZR18
18" x 9.5"	Not Recommended	
18" x 10"	Not Recommended	

\* 17" wheels require a minimum inside wheel diameter of 16.250"

Caution: Some brake applications will not work with 17" wheels. Flush mount valve stems may also be required on wheels with a behind center valve stem location.

Specifications – Detroit Speed Front Subframe	
Total Suspension Travel	6"
Ride Height*	2.9" ± 1.0"
Static Camber	-0.5° ± 0.2°
Static Caster	+7.5° ± 0.5°
Static Toe	0.0° ± 0.1°
*Measured from the top of the frame rail to the center of the hub	

**1967-69 Camaro/Firebird Engine Fitment – Detroit Speed Front Subframe**

**SBC/BBC Engines**

Engine	Mounting	Oil Pans	Headers
Small Block Chevy	Stock type mounts & brackets	Stock or Aftermarket	Patriot: PN: H8056 (mid-length) PN: H8047 (full-length) Hooker Headers: PN: 2131 (1-3/4" full-length) Lemon's Headers: SBPT-202
Big Block Chevy		GM PN: 12495360 (one-piece rear main seal)	Patriot: PN: H8012 (mid-length) Doug's Header's: PN: D313R (full-length) Lemon's Headers: PN: BBPT-660
Pontiac	DSE PN: 060412DS (Brackets only, use 1 <sup>st</sup> Gen Pontiac mounts)	Aftermarket	Custom

**LS Engines**

Engine	Engine Mounting Kits/Engine Oil Pan Usage	Headers	Comments
LS1*, LS2* & LS3*	DSE PN: 060401DS (Positions engine in a stock location)  Oil Pan: Stock 4 <sup>th</sup> Gen F-Body PN: 12628771, Champ PN: LS1000, Mast Motorsports PN: 401-111 or Holley PN: 302-2, 302-3, 302-5 Or DSE PN: 060404DS (Moves engine rearward from stock 1.5")  Oil Pan: Stock GM LS1, LS2 or LS3, Corvette GM PN: 12624617 or Mast PN: 401-111 or Holley PN: 302-2, 302-3, 302-5	DSE PN: 061001DS (Requires use of DSE Engine Mount Kit PN: 060404DS)	A/C compressor will need to be relocated to the top of the engine to clear the crossmember. Use Holley or Vintage Air front drive system
	DSE PN: 060401DS (Positions engine in a stock location)  Oil Pan: Stock GM Oil Pan NOTE: Use GM PN: 25534412 or Peterson Fluid Systems for dry sump fittings to drain oil pan Or DSE PN: 060404DS (Moves engine rearward from stock 1.5") Stock GM Oil Pan, Corvette Dry Sump Pan GM PN: 12626225		A/C compressor will need to be relocated to the top of the engine to clear the crossmember. Use Holley or Vintage Air front drive system Need to use Camaro style damper/pulley

**\*NOTE: For aftermarket LS engines (i.e., Mast Motorsports), refer to manufacturer for specific oil pan usage and use chart above for correct Detroit Speed Engine Mounting Kit.**

**1970-81 Camaro/Firebird Engine Fitment – Detroit Speed Front Subframe**

**SBC/BBC Engines**

Engine	Mounting	Oil Pans	Headers	Comments
Small Block Chevy	DSE PN: 060411DS	Stock or Aftermarket	DSE PN: 061003DS or 061004DS	*Engine located 1.5" rearward of stock location
Big Block Chevy		GM PN: 12495360 (one-piece rear main seal)	Lemons Headers	
Pontiac	DSE PN: 060413DS (Brackets only, use 1 <sup>st</sup> Gen Pontiac mounts)	Aftermarket	Custom	

LS Engines				
Engine	Mounting	Oil Pans	Headers	Comments
LS1, LS2 & LS3	DSE PN: 060414DS	LS2/LS3 Corvette GM PN: 12624617	DSE PN: 061001DS (Requires use of DSE Engine Mount Kit PN: 060414DS)	*Engine located 1.5" rearward of stock location
		Champ PN: LS1000		
LS7 & LS9		4 <sup>th</sup> Gen F-Body GM PN: 12628771		
		Mast Motorsports PN: 401-111		
		Holley PN: 302-2, 302-3, or 302-5		
		Corvette Dry Sump GM PN: 12626225		

\*NOTE: When using the Detroit Speed engine mount kits, the firewall/tunnel may need to be modified.

Hardware Checklist - Detroit Speed Front Subframe			
Part Number	Description	Quantity	Check
<b>9903020</b>	<b>Rack &amp; Pinion Hardware Bag</b>	<b>1</b>	
980033FS	9/16"-18 x 5-1/2" L Hex Head Cap Screw, Grade 8, Yellow Zinc	2	
970020FS	9/16" SAE Flat Washer, Yellow Zinc	2	
99090041	Rack & Pinion Spacer, Aluminum	2	
<b>9303021</b>	<b>Sway Bar Hardware Box (5x5x5)</b>	<b>1</b>	
950059FS	3/8"-24 x 2-1/2" L Hex Head Cap Screw, Grade 8, Yellow Zinc	2	
960032FS	3/8" Nylon Insert Locknut, Grade 8, Yellow Zinc	2	
970035FS	3/8" AN Flat Washer, Yellow Zinc	4	
960034FS	M12-1.75 Hex Jam Nut, Clear Zinc	2	
960036FS	M12-1.75 Nylon Insert Locknut, Clear Zinc	2	
970026FS	M12 Flat Washer, Clear Zinc	4	
99030106	Sway Bar End Link-C6 (GM PN: 15288535)	2	
9303073	1-1/4" Double Split Lock Collar, Steel, Black Zinc	2	
<b>9303022</b>	<b>Lower Control Arm Hardware Bag</b>	<b>1</b>	
980019FS	9/16"-18 x 3-1/2" L Hex Head Cap Screw, Grade 8, Yellow Zinc	2	
980034FS	9/16"-18 x 3-3/4" L Hex Head Cap Screw, Grade 8, Yellow Zinc	2	
960022FS	9/16"-18 Nylon Insert Locknut, Grade 8, Yellow Zinc	4	
970020FS	9/16" SAE Flat Washer, Yellow Zinc	8	
<b>9303023</b>	<b>Upper Control Arm Hardware Bag</b>	<b>1</b>	
980026FS	1/2"-20 x 2-1/2" L Hex Head Cap Screw, Grade 8, Yellow Zinc	4	
960031FFS	Upper Control Arm Cross Shaft Mount Nut, Yellow Zinc	4	
970019FS	1/2" AN Flat Washer, Yellow Zinc	8	
920009FS	1/8" Thick, 1/2" Slot, 1 1/8" x 1 1/8" Shim, Bright Zinc	8	
<b>9303025</b>	<b>Bump Stop, Upper Control Arm Hardware Bag</b>	<b>1</b>	
960033FS	5/16"-18 Nylon Insert Locknut, Clear Zinc	2	
970027FS	5/16" SAE Flat Washer, Grade 5, Clear Zinc	2	
99030060	5/16"-18 x 5/8" Bump Stop - 3/4" x 1-3/4" x 1-3/8"	2	

<b>9303024</b>	<b>Shock Hardware Bag</b>	<b>1</b>	
980021FS	1/2"-20 x 3-1/2" L Hex Head Cap Screw, Grade 8, Yellow Zinc	2	
960004FS	1/2"-20 Nylon Insert Locknut, Grade 8, Yellow Zinc	2	
970037FS	1/2" SAE Flat Washer, Yellow Zinc	2	
980035FS	3/8"-24 x 1-1/4" L Hex Head Cap Screw, Grade 8, Yellow Zinc	4	
960032FS	3/8"-24 Nylon Insert Locknut, Grade 8, Yellow Zinc	4	
970023FS	3/8" SAE Flat Washer, Yellow Zinc	4	
99030021F	3/8" OD, 1/2" ID, x 7/8" L Steel Bushing, Electroplate	2	
031060	Detroit Speed/JRi Spanner Tool	1	
031062	Torrington Bearing Set (2-Thrust Bearing, 4-Thrust Washer)	1	
<b>9303026</b>	<b>C6 Upright Hardware Bag (With GM Uprights Only)</b>	<b>1</b>	
960036FS	M12-1.75 Nylon Insert Locknut, Clear Zinc	2	
970026FS	M12 Flat Washer, Clear Zinc	2	

<b>Fastener Torque Specifications - Detroit Speed Front Subframe</b>		
<b>Application</b>	<b>Torque (ft-lb)</b>	<b>Threads</b>
Lower Control Arm Mounting Bolts	95	Anti-Seize
Rack and Pinion Mounting Bolts	95	Anti-Seize
Sway Bar Shaft Clamp Screw	14	Blue Loctite 242
Sway Bar Link Nuts	40 on top nut - 45 on bottom nut	Red Loctite 262
Upper Control Arm Cross-shaft Mounting Bolts	75	Red Loctite 262
Upper Coilover Shock Mounting Bolts	60	Anti-Seize
Lower Coilover Shock Tie Bar Bolts	35	Anti-Seize
Sway Bar Arm Mounting Bolt	25	Anti-Seize
Tie Rod End Jam Nut	45	Anti-Seize
Upper Control Arm Ball Joint Stud Nut	40	
Lower Control Arm Ball Joint Stud Nut	20 then turn an additional 180°	Red Loctite 262
Tie Rod End Stud Nut*	35	Anti-Seize
Wheel/Hub Bearing Mounting Bolts	95	Red Loctite 262
Steer Arm Mounting Bolts	60	Red Loctite 262
Body Mount Bolts	90	
Radiator Support Mount Bolts	35	
Front Brake Caliper Mounting Bracket Bolts	125	
Wheel Stud Nuts	100	
*Always tighten slotted nuts to line up with the cotter pin hole when applicable.		

### **IMPORTANT:**

1. If you have purchased the bare metal, unassembled option for the Detroit Speed Hydroformed Subframe, the upper and lower control arms **CAN NOT** be powder coated since they come already assembled from DSE. The temperatures from this process will destroy the control arms beyond repair.

The DSE upper control arms **CAN NOT** be taken apart because of the precise assembly procedure at Detroit Speed. The upper control arm cross shaft nuts are torqued and then pinned in place. Failure to follow the correct procedure will damage the upper control arms beyond repair. Any attempt at taking apart any of the DSE subframe components before calling Detroit Speed will void any warranty. If you have any questions, please call DSE at 704-662-3272.

2. If the lower control arm ball joint stud needs to be serviced after the initial torque setting listed above for a coilover spring change, etc. use the following information to re-assemble the lower control arm and upright:
  - a) Before you remove the ball joint nut, make a line with a marker from the top of the nut down to the upright and then loosen the ball joint nut.
  - b) Upon re-assembly, torque the ball joint nut to 20 ft-lbs. and then tighten the nut until the line on the nut goes back to the line on the upright so it is back in the same location as the initial torque setting.
3. If the upper ball joint needs to be replaced, the upright assembly must be returned to Detroit Speed to be serviced. Failure to follow this procedure before calling Detroit Speed will void any warranty. If you have any questions, please call DSE at 704-662-3272.

**CAUTION:**

The Detroit Speed serial number tag is the best identification record of your subframe when contacting DSE to determine when your subframe was assembled for any warranty issues should you need them (Figure 1). For customers that have ordered the raw subframe we recommend not powder coating the frame as that will cause permanent damage to your serial tag number. If it is damaged, it would be much more difficult to properly ID your Detroit Speed subframe.



Figure 1 - Subframe Tag

**1967-69 Camaro/Firebird & 1968-74 Nova ONLY - Detroit Speed Bolt-on Z-bar Bracket (PN: 032104DS):** If you purchased the Bolt-on Z-bar Bracket, Detroit Speed has a bracket for this application. The Bolt-on Z-bar Bracket provides a simple and effective way of mounting a bracket to the front frame for the factory Z-bar bracket.

1. Pilot holes for the Bolt on Z-bar Bracket are located in the frame rails. The appropriate holes in the front frame must be drilled larger to be tapped (Figure 2).

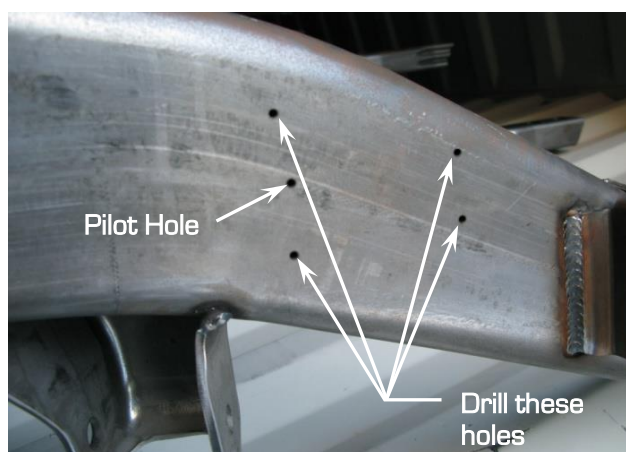

Figure 2 - Locating the Holes to be Drilled

2. Drill the holes out using a “J” drill bit. Using the appropriate tools, tap the drilled holes to 5/16” - 24.
3. Before bolting the Detroit Speed Bolt-on Z-bar Bracket to the front frame, attach the factory Z-bar support. Use the provided hardware to attach the Z-bar Bracket to the front frame.

**NOTE:** Be sure the frame rails are free of any loose media or particles that may have collected in the rails from paint or powder coat. Do this with compressed air. Pay particular attention to the front crossmember. Any foreign particles left in the front crossmember could possibly damage the Anti-roll bar end support bushings.

### 1. Install lower control arm assemblies.

- a) Locate the correct lower control arm (driver or passenger side). This is referenced by the bump stop located on the forward leg of the front frame (Figure 3).



Figure 3 - Passenger Side Control Arm Shown

- b) Be sure to use the correct 9/16”-18 bolts to mount the lower control arms. The short bolt (9/16”-18 x 3-1/2” L) is used in the forward leg of the control arm and the long bolt (9/16”-18 x 3-3/4” L) is used in the rear leg of the control arm. Both bolts must point forward (i.e., bolt head toward the rear) or the bolts and the control arm will not be able to be removed once the front frame is fully assembled. Use anti-seize on the threads of the bolts. Using the provided 9/16”-18 Nylock nuts and washers, torque the lower control arm bolts to 95 ft-lbs.

### 2. Install the upper control arm assemblies.

- a) When installing the upper control arms, be sure to distinguish between the driver and passenger side upper control arms (Figure 4a on the next page). Install the provided 1/2” AN flat washers on both the head and nut side of the 1/2”-20 x 2-1/2” L bolts (Figure 4b and 4c on the next page).
- b) Apply High Strength Red Loctite 262 to the threads of the bolts before installing the 1/2”-20 upper control arm cross-shaft nuts.
- c) Once the cross-shaft nuts have been installed loosely, insert one 1/8” shim on each bolt and torque the bolts to 75 ft-lbs. (Figure 4d on the next page).



Figure 4a - Driver & Passenger Upper Control Arms

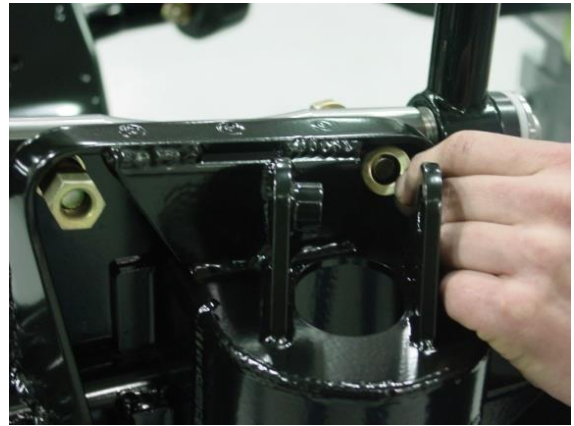

Figure 4b - Installing the Hardware



Figure 4c - Installing the Hardware

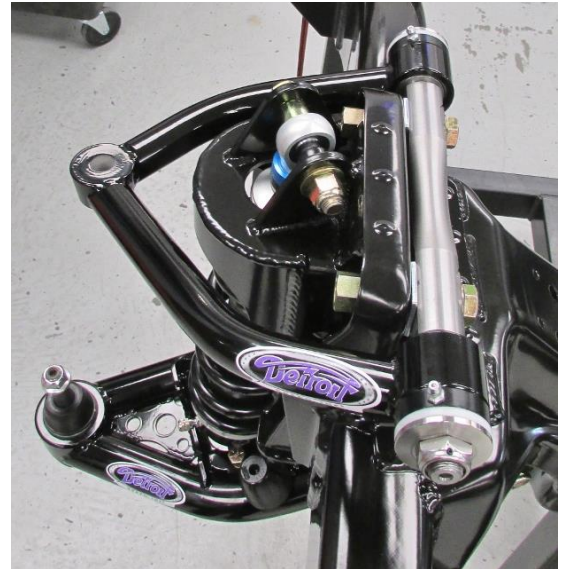

Figure 4d - Installed Upper Control Arm

### 3. Install the bump stops for the upper control arms.

- a) Install the bump stops onto the frame pad located behind the upper coilover mount using the provided 5/16"-18 Nylock nuts and washers and tighten (Figure 5).



Figure 5 - Bump Stop  
Page 8 of 22



#### 4. Install each coilover assembly.

a) Before installing each coilover, it is necessary to build each assembly.

- (1) Remove the upper spring seat from the retaining ring using a rubber hammer and moving it down off the upper shock mount (Figure 6).
- (2) Remove the retaining ring from the upper shock mount and pass the upper spring seat over the upper shock mount (Figure 7).



Figure 6 – Removing the Upper Spring Seat



Figure 7 – Upper Spring Seat & Retaining Ring

- (3) Thread the spanner nut all the way to the bottom of the coilover shock and install the Torrington bearing set (Figure 8) on each shock by installing one thrust washer, followed by the roller bearing and then another thrust washer. Detroit Speed recommends using high pressure grease between the roller bearing and thrust washers.

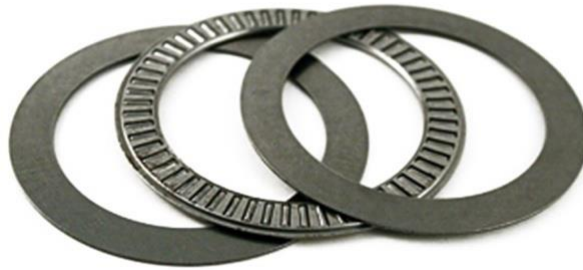

Figure 8 – Torrington Bearing Set

- (4) Slide the coilover spring over the top of the upper shock mount.
- (5) Install the upper spring seat back over the top of the upper shock mount and re-install the retaining ring back onto the upper shock mount. Press the upper spring seat up onto the retaining ring so it locks in place.

The coilover assembly is now complete and ready to be installed.

- b) Make sure the upper mounting holes are clean and free of any paint, so the bolts and spacers slide into the mounting tabs.
- c) Slide the provided 1/2"-20 x 3-1/2" L upper shock bolt and 1/2" x 7/8" L spacer through the upper coilover tab. Make sure that the bolt is facing forward (i.e., the bolt head is toward the rear). Install the bolt through the eyelet of the shock so it passes through the welded bushing on the upper coilover tab. Use anti-seize on the threads of the bolt and install the provided 1/2"-20 Nylock nut and washer (Figure 9 on the next page).

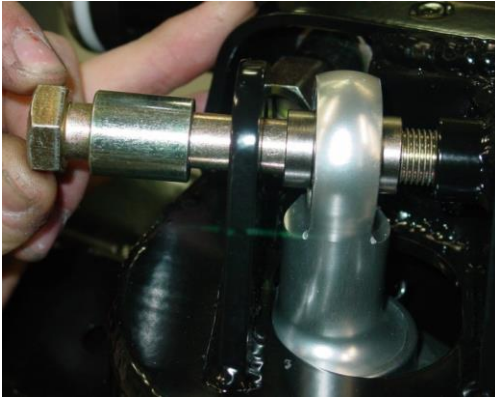

Figure 9 - Upper Shock Bolt and Spacer

- d) Position the lower coilover mount to the lower control arm. Install the two 3/8"-24 x 1-1/4" L lower shock retaining bolts from the top side of the control arm so that the 3/8" Nylock nuts and washers are on the bottom of the lower control arm (Figure 10). Use anti-seize on the threads of the bolts. **NOTE:** For the double adjustable remote canister shock upgrade, make sure that the canister hose is facing towards the lower ball joint. Failure to do this will cause permanent damage to the canister hose during suspension travel as the lower control arm gusset has been notched in this location (Figure 11).

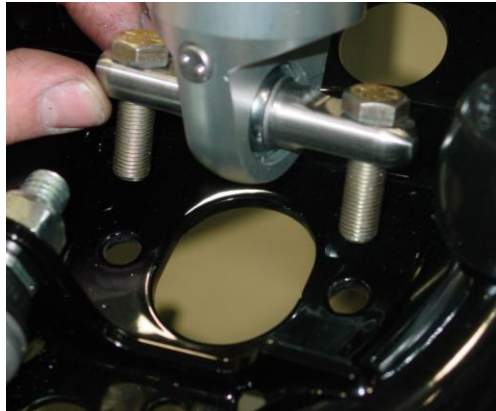

Figure 10 - Lower Shock Retaining Bolts



Figure 11 - Remote Canister Shock

- e) Repeat steps b through d to install the opposite side shock and spring assembly. Torque the 1/2"-20 upper shock hardware to 60 ft-lbs. and the 3/8"-24 lower control arm hardware to 35 ft-lbs. Figure 12 shows a completed and installed coilover shock and spring assembly.

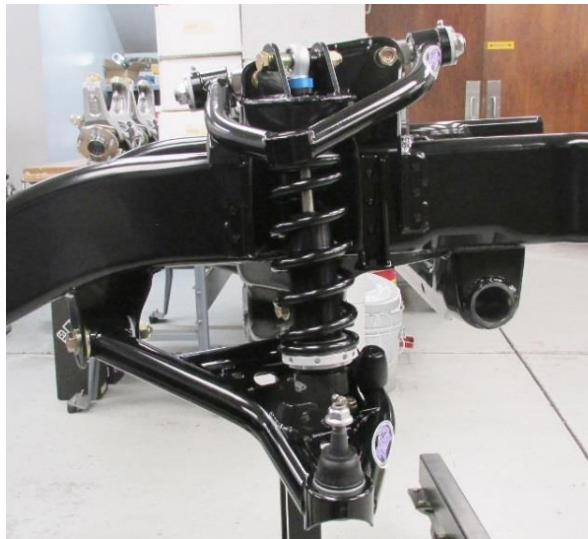

Figure 12 - Installed Coilover View (Passenger Side)

5. Install the rack and pinion assembly.

- a) Before the rack and pinion is installed, you can center the rack on the bench before it is installed. Mark a line along the length of the input shaft. Turn the rack all the way to one side and mark the housing where the line on the input shaft lines up. Turn the rack all the way in the other direction and count the turns in the opposite direction. Mark the housing where the line on the input shaft lines up. Turn the rack back in the opposite direction 1/2 the amount of turns so that the line on the input shaft lands in between your two marks on the housing (Figure 13).



Figure 13 – Center the Rack & Pinion

- b) When installing the rack and pinion, protect the opening in the crossmember to avoid paint chips as it gets very tight in several areas. Install the rack and pinion assembly **from below the crossmember** for better clearance and easier alignment. **NOTE:** Since the rack and pinion fits tight to the crossmember this would be a good time to install your fittings before it is fully installed. You can reference Figure 28 for the location of the pressure and return ports.
- c) Rotate the rack to the rear of the front frame to install in the crossmember in the correct position (Figure 14).

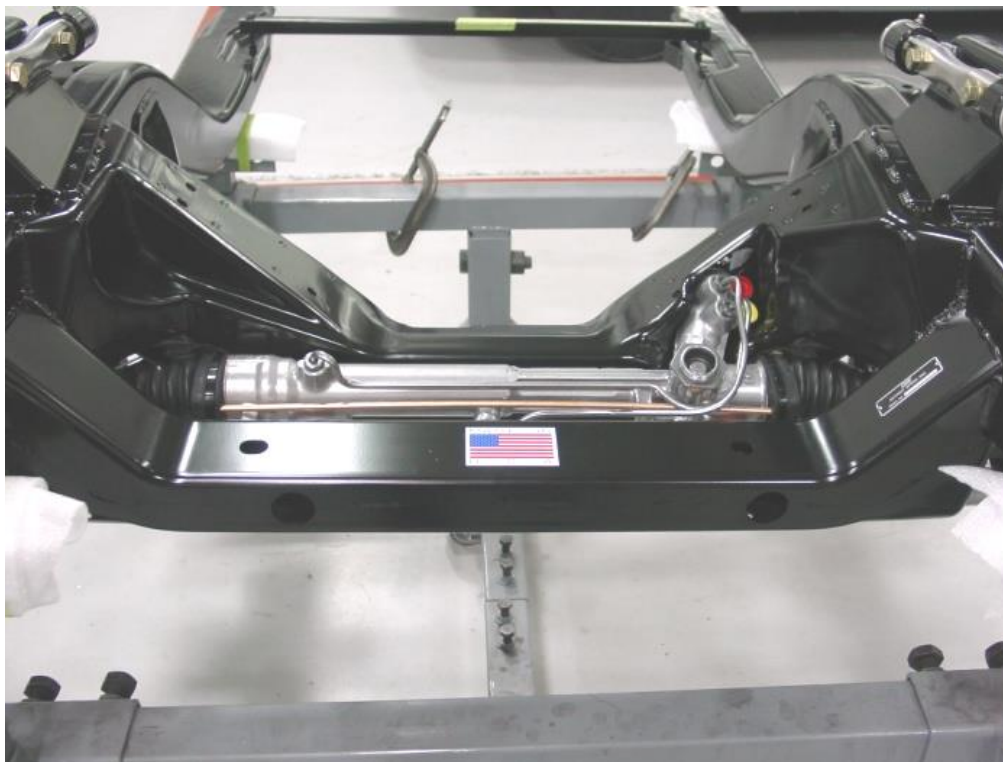

Figure 14 – Positioning the Rack & Pinion

- d) Once the rack is in place, slide the aluminum spacers in place between the rack and the forward crossmember and install the provided 9/16"-18 x 5-1/2" L hex head bolts with SAE washers (Figure 15). Use anti-seize on the bolts and torque to 95 ft-lbs.



Figure 15 - Attaching the Rack to the Cross Member

#### 6. Install the outer tie rod ends.

- Apply anti-seize to the tie rod end threads, then thread the outer tie rod ends onto the rack and pinion.
- When installing the tie rod ends, make sure they are equal distance on each side to center the steering. This measurement should be approximately 2-1/4" per side. Measure this from the end of the threads to the outer edge of the nut. [Figure 16].
- Torque the tie rod end jam nuts to 45 ft-lbs. and thread the grease fittings into the tie rod ends.

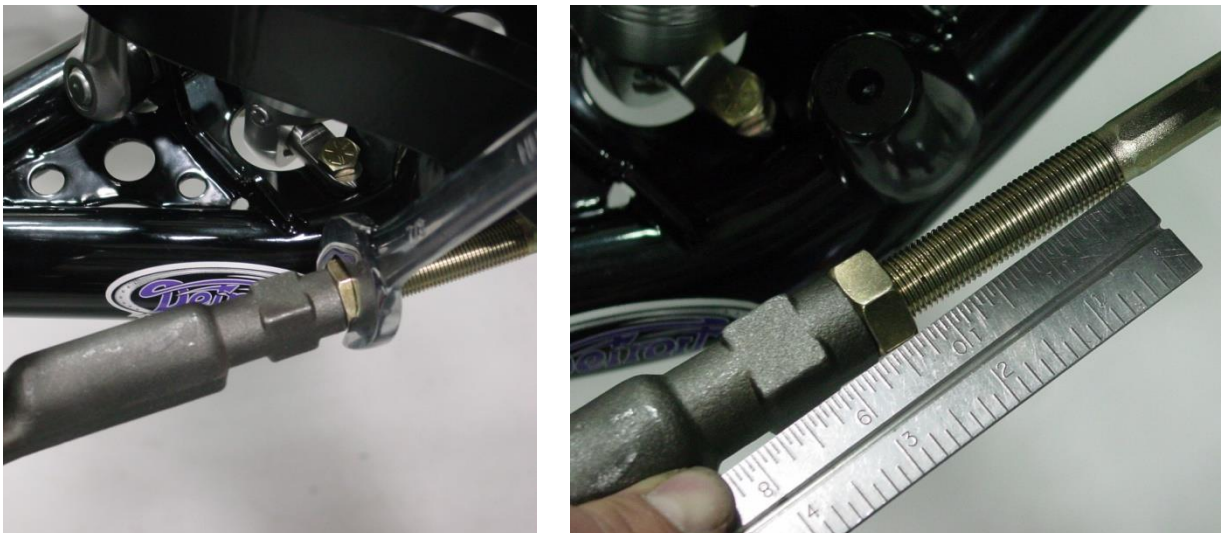

Figure 16 - Measuring the Outer Tie Rods

#### 7. Install the sway bar.

- Lube the outside of the composite bushings with soapy water. Lube the inside of the bushing and do your best to fill the interior bushing grooves with chassis grease.
- Before sliding the sway bar in place, clean the outside of the bar thoroughly with lacquer thinner to remove any foreign materials from the bar.

- c) Once the bar is clean, slide the bar in place. After the bar is in place, install the composite bushings. The bushings may not push in completely by hand. Do not be concerned, as they are designed to be a very precise fit (Figure 17). With the bar and both bushings installed, use a large diameter socket and a rubber hammer to seat the bushings on both sides at this time (Figure 18).



Figure 17 – Installing Bushing & Sway Bar



Figure 18 – Fully Installing the Bushings

- d) After installing the bar and pushing the bushings in all of the way, center the bar in the crossmember. Measure the portion protruding from the bushings on each side (Figure 19) and adjust accordingly until this measurement is the same on both sides. Make sure to re-seat the bushings against the frame before measuring, as they can shift when you adjust the bar and throw off your measurements.



Figure 19 – Measuring the Sway Bar

- e) Install the provided 1-1/4" sway bar shaft clamps next. Loosen both Allen screws in the lock collar. Apply Medium Strength Blue Loctite 242 to the threads and position the clamp onto the sway bar. With the heads of the bolts accessible from the bottom, torque the Allen screws to 14 ft-lbs. **NOTE:** Be sure that the groove in the clamp is installed so that it points to the center of the front frame and the size marking is to the outside, and that the two clamps match on either side (Figure 20 on the next page).



Figure 20 - Indexing the Clamp

**8. Install the sway bar arms to the sway bar tube.**

- a) Before the sway bar arms are installed, push the outer tie rods on the rack and pinion down as far as they will go. They need to stay below the sway bar arms once they are installed.  
**WARNING:** If you install the sway bar arms with the outer tie rods above the arms you will not be able to install them into the steering arm without removing the sway bar arms.
- b) Make sure both arms are positioned the same on the splines and are even in relation to one another.
- c) When both arms are on the same splines, use the provided 3/8"-24 x 2-1/2" L hex head cap screws and bolt them in place with the 3/8" Nylock nuts and washers. Install the bolts from the top so that the Nylock nuts are on the bottom side of the bar. Use anti-seize on the threads of the bolts.
- d) Torque the sway bar arm 3/8"-24 retaining bolts to 25 ft-lbs. (Figure 21).

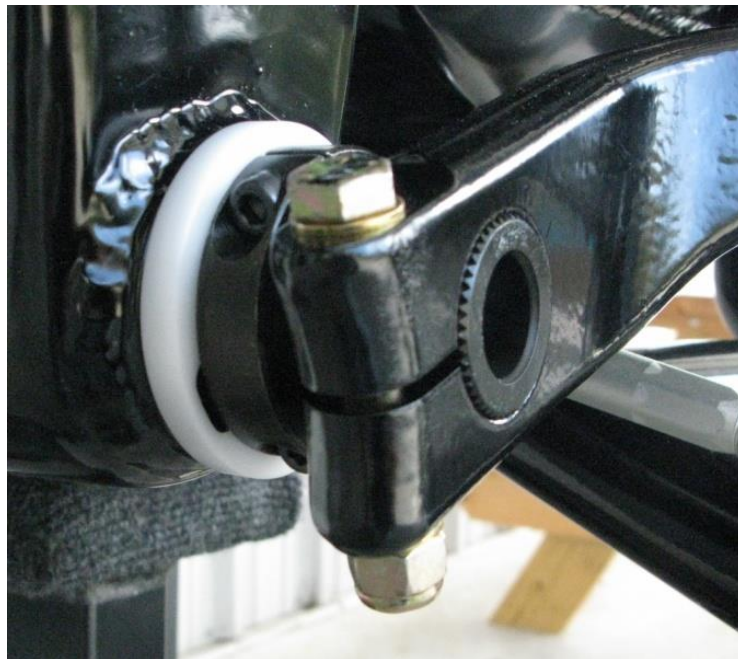

Figure 21 - Attach the Sway Bar Arm

**9. Install the sway bar end links to the lower control arms.**

- a) These must be installed on the lower control arms now as tightening the links later can be very difficult.
- b) Use the included M12 x 1.75 Nylock nuts and washers. When installing the lower Nylock nut, use High Strength Red Loctite 262 on the threads (Figure 22 on the next page).



Figure 22 – Attach the End Link to the Lower Control Arm

- c) Repeat the above process for the opposite side and torque the lower Nylock nuts to 45 ft-lbs.

**10. Connect the sway bar arms to the end links.**

- a) Connect the sway bar arm to the upper sway bar end link on either side. Use High Strength Red Loctite 262 on the threads when installing the provided M12 x 1.75 jam nut and washer and torque to 40 ft-lbs. [Figure 23].



Figure 23 – Attach the Sway Bar Arm to the End Links

- b) Reposition the lower control arm on the side that is being installed last.
- c) Install the upper sway bar end link to the sway bar arm with the M12 x 1.75 jam nut and washer. Again, use High Strength Red Loctite 262 on the threads and torque to 40 ft-lbs.

**11. Install the Detroit Speed spindle assembly.**

- a) Clean any grease from the upper and lower ball joint studs and the spindle holes with a clean rag and lacquer thinner.
- b) Install the spindle to the upper control arm first.
- c) Tighten the upper ball joint flanged lock nut and torque to 40 ft-lbs.
- d) Place the spindle on the lower ball joint.
- e) Tighten the lower ball joint flanged lock nut and torque to 20 ft-lbs. plus 180° clockwise. **NOTE: It is critical to follow the torque procedure in the table on page 4 and to use High Strength Red Loctite 262 on the lower ball joint threads.**

- f) Insert the outer tie rod end into the steer arm. **NOTE:** Turn and position the stud so the cotter pin locates from front to rear to ease installation. Torque to 35 ft-lbs. and install the cotter pin (Figure 24).



Figure 24 - Attach the Outer Tie Rod to the Steering Arm

12. The front subframe is assembled at this point. Figures 25 and 26 show a completed installation. Double-check to ensure that all installed components are tight and torqued correctly.

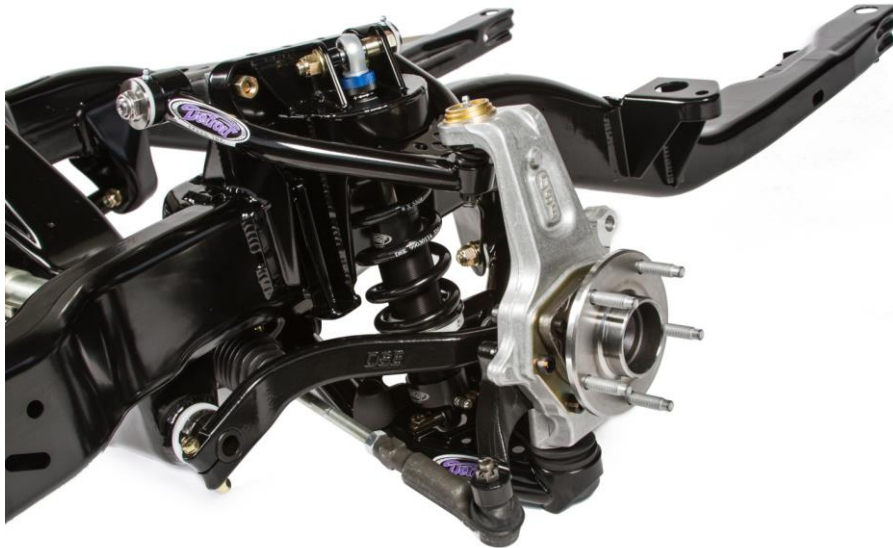

Figure 25 - Fully Assembled View (Driver side, Front)



Figure 26 - Fully Assembled View (Driver side, Rear)



13. Install the front subframe in the vehicle. It is very important that the front subframe be centered in the vehicle.
- Position the vehicle on level and solid ground. Support the vehicle using jack stands at four corners of the body.
  - Locate the lower control arm forward mounting locations and drop a plumb line to the ground and mark the locations.
  - On the rear of the car, locate the round flanged hole in the frame rail that is next to the rear spring pockets. Drop a plumb line from this location on both sides and mark the locations.
  - Measure diagonally from these locations to see if the front subframe is square. The difference between the two measurements should be  $1/16$ " or less. If the front subframe is not square, loosen the front subframe mounts and reposition.
14. When installing the front subframe in 1968-1974 Nova applications, it is necessary to use the factory body mount spacers. The spacers install at the forward body mounts and install between the body mounts and the body (Figure 27).



Figure 27 - Nova Body Mount Spacers

15. After the front subframe is installed into the vehicle, the power steering hoses can be attached to the rack and pinion. Follow Figure 28 for the location of the pressure and return ports.

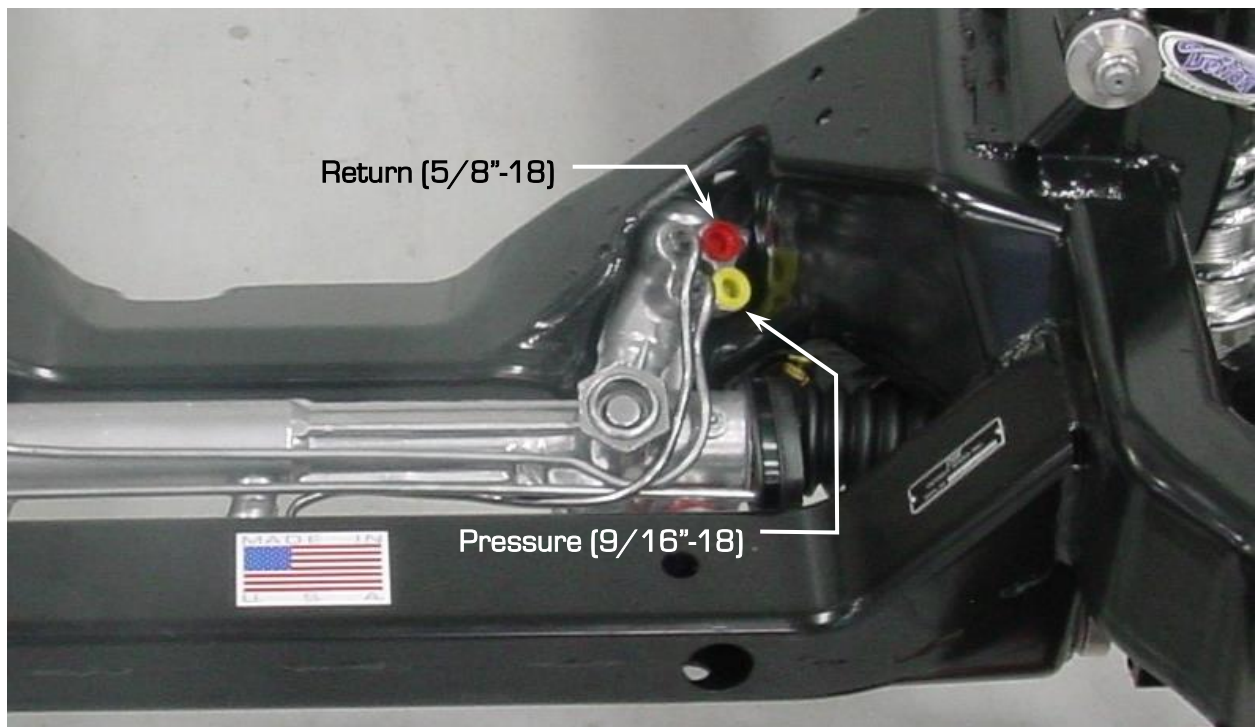

Figure 28 - Location of Pressure and Return Ports

16. The front subframe is now assembled and installed. **NOTE:** Be sure to lubricate all points on the front frame with quality chassis grease.

17. When installing the engine in the front subframe on LS7 applications, the Detroit Speed Hydroformed Front Subframe is designed to accept the stock oil pan and drain plug. However, the design does not allow the drain plug to be functional. To drain the oil from the engine, the hose adapters on the oil pan must be used. The manufacturer and part numbers for the hose adapters are shown in the engine fitment section on page 2. Follow the manufacturer guidelines for the installation of this hose kit.

**18. Setting the vehicle ride height.**

- a) With the vehicle assembled with all components installed, adjust the vehicle ride height. Before adjusting the ride height, Detroit Speed recommends cleaning the threads of the shock. Once the threads are clean, Detroit Speed recommends applying dry bicycle chain lube to the threads of the shock body before adjusting the spanner nut and compressing the coilover spring. Allow the chain lube to dry before adjusting the spanner nut. If you have the non-adjustable shocks, the spanner nut has a soft tip set screw that will need to be tightened before the vehicle is driven.
- b) Detroit Speed does include a Spanner Tool (PN: 031060DS) to adjust ride height however if you have the adjustable coilover shocks, Detroit Speed does offer an Adjustment Tool available as PN: 031061DS if needed (Figure 29).



**Figure 29 – Detroit Speed Spanner & Adjustment Tools**

19. If the Single Adjustable, Double Adjustable, or the Double Adjustable Remote Canister Coilovers were purchased as an upgrade, refer to the following information for adjustment procedures.



Thank you for your recent purchase from JRi Shocks. Your shocks were hand-assembled in Mooresville, NC by one of our experienced technicians using only the highest quality components.

**Terms and Conditions of Sale**

The JRi Shocks Terms and Conditions of Sale control the purchase of this item and can be reviewed at [www.jrishocks.com/terms](http://www.jrishocks.com/terms)

**Limited 1-Year Warranty**

Your product comes with a Limited 1-Year Warranty. In order to be eligible for service under this warranty you **MUST** complete the online warranty registration at [www.jrishocks.com/warrantyreg](http://www.jrishocks.com/warrantyreg) within 30 days from the date of purchase.

## Detroit Speed Single Adjustable Shock Applications

To change from the recommended “Detroit Tuned” valving, adjustments can be made independently to the rebound setting. The rebound is controlled by the knob at the upper shock mount (Shock is mounted body side down). The knob rotates clockwise (+) to increase the damping and counterclockwise (-) to decrease the damping (Figure 30a).



Figure 30a - Detroit Speed Single Adjustable Shock

To return to the Detroit Speed recommended settings, turn the knob clockwise (+) to full damping. Once at full damping, turn counterclockwise (-) to reach the recommended settings. Refer to Figure 30b for the rebound settings.

Rebound (Shaft Knob) ..... 15 Open (counterclockwise, -)

Figure 30b - Detroit Speed Recommended Settings

### Adjuster Operation

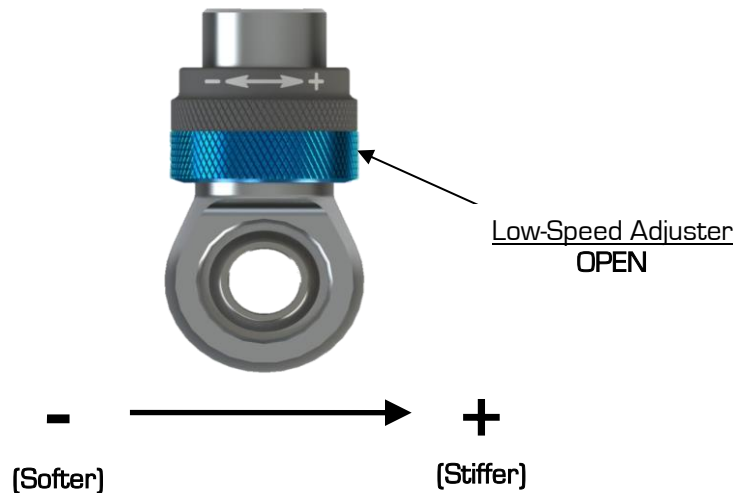

- **Adjuster (60 Clicks)**

The low-speed adjuster is a “clicker” style adjuster meaning that its adjustment is measured by detents located inside the blue adjuster knob. There are 16 clicks per 1 revolution of the knob. It uses a right-hand thread in its operation which means as you increase low speed, the adjuster will move up on the eyelet. The recommended change for an adjustment is 8 clicks at a time. The low-speed adjuster’s reference position is **full stiff** (closed, or all the way up) and referred to -0 [-0 = full stiff, -60 = full soft].

- **Tuning Notes**
  - **Racetrack**
    - For more grip, soften the damping.
    - For increased platform control, stiffen the damping.
  - **Street**
    - For a more comfortable ride, soften the damping

**\*DO NOT FORCE KNOB WHEN IT STOPS TURNING, YOU MAY DAMAGE THE ADJUSTER AND INTERNAL HARDWARE**

***Detroit Speed Double Adjustable Shock Applications***

To change from the recommended “Detroit Tuned” valving, adjustments can be made independently to both the high and low speed settings. The rebound is controlled by the sweepers at the upper shock mount. The sweepers rotate clockwise (+) to increase the damping and counterclockwise (-) to decrease the damping (Figure 31a).



**Figure 31a – Detroit Speed Double Adjustable Shock**

When adjusting the low speed rebound start at full (+) position, when adjusting the high speed rebound start at full (-) position. To return to the Detroit Speed recommended settings turn the sweeper clockwise (+) to full damping for the low speed setting, and counterclockwise (-) to full damping for the high speed setting. Once at full damping, turn counterclockwise (-) for the low speed setting, and clockwise (+) for the high speed setting to reach the recommended settings. Refer to Figure 31b for recommended settings.

Low Speed Rebound [Sweeper]..... 15 sweeps [counterclockwise](-)  
 High Speed Rebound [Sweeper]..... 4 sweeps[clockwise](+)

**Figure 31b – Detroit Speed Recommended Settings**

***Detroit Speed Double Adjustable Shocks w/Remote Canisters***

To change from the recommended “Detroit Tuned” valving, adjustments can be made independently to both the high and low speed settings. The rebound is controlled by the sweepers at the upper shock mount. The sweepers rotate clockwise (+) to increase the damping and counterclockwise (-) to decrease the damping (Figure 32a on the next page).



Figure 32a – Detroit Speed Double Adjustable Shock w/Remote Canister

When adjusting the low speed rebound start at full (+) position, when adjusting the high speed rebound start at full (-) position. To return to the Detroit Speed recommended settings turn the sweeper clockwise (+) to full damping for the low speed setting, and counterclockwise (-) to full damping for the high speed setting. Once at full damping, turn counterclockwise (-) for the low speed setting, and clockwise (+) for the high speed setting to reach the recommended settings. Refer to Figure 32b for recommended settings.

- Low Speed Rebound [Sweeper]..... 15 sweeps [counterclockwise][-]
- High Speed Rebound [Sweeper]..... 4 sweeps[clockwise][+]

Figure 32b – Detroit Speed Recommended Settings

**Adjuster Operation**

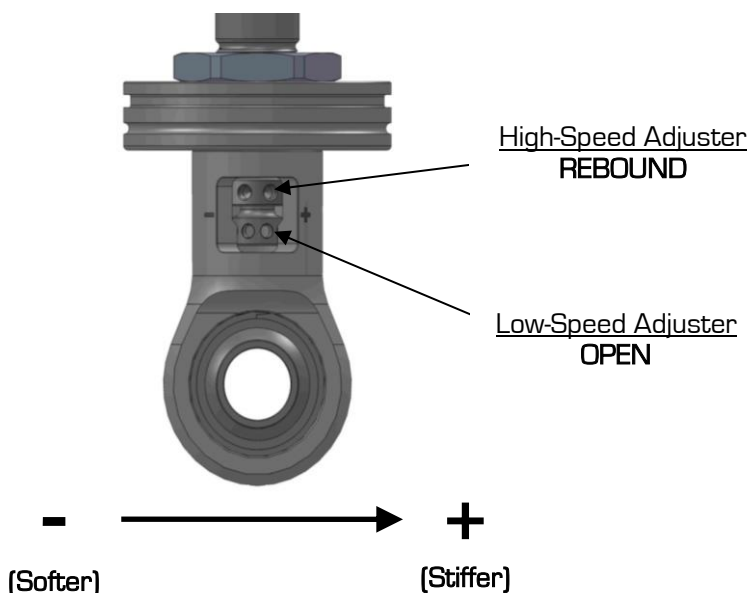

- **High-Speed Adjuster (12 Sweeps)**

The high-speed adjuster is a “sweep” style adjuster meaning that its adjustment is measured by the location of the adjuster in the eyelet window. It uses a left-hand thread in its operation which means; as you increase high-speed, the adjuster will move down in the window\*. The high-speed adjuster’s reference position is **full soft** and referred to as +0 (+0 = full soft, +12 = full stiff).

- **Low-Speed Adjuster (30 Clicks)**

The low-speed adjuster is a “clicker” style adjuster meaning that its adjustment is measured by detent grooves located inside the high-speed shaft. It uses a right-hand thread in its operation which means; as you increase low speed, the adjuster will move up in the window. The low-speed adjuster’s reference position is **full stiff** and referred to -0 (-0 = full stiff, -30 = full soft).

*\*The low-speed adjustment does not change when adjusting the high-speed.*

To aid in the installation of the reservoirs, we also offer a set of Billet Aluminum Remote Canister Mounts. The canister mounts are available exclusively through DSE, PN: 032102DS (Figure 33).



**Figure 33 – Billet Aluminum Remote Canister Mounts**

20. Have a professional alignment completed following the specs given in the chart on Page 2.

If you have any questions before or during the installation of this product, please contact Detroit Speed at [tech@detroitsspeed.com](mailto:tech@detroitsspeed.com) or 704.662.3272

**Legal Disclaimer:** Detroit Speed is not liable for personal, property, legal, or financial damages from the use or misuse of any product we sell. The purchaser is solely responsible for the safety and performance of these products. No warranty is expressed or implied.