

Classic Instruments

Six
PACK
Pack

Installation Manual

Table of Contents

Welcome from the Team at Classic Instruments!	3
Universal, “Shoebox” & ’61-’66 F100 Gauge Mounting	4
“Bronc Package” Gauge Mounting.....	5
“Classic Line Package” Gauge Mounting.....	6
Gauge Cluster Wiring	7
Dash Light Dimmer.....	8
Gauge Wiring Diagram	9
Oil Pressure Sender Installation	10
Temperature Sender Installation	11
Optional Pulse Signal Generator [SN16] Wiring.....	11
Universal Fuel Level Sender Installation.....	12
Speedometer & Tachometer Calibration.....	13
Entering Calibration Mode:	13
Tachometer Cylinder Setup:	14
Tachometer Signal Type Setup:	15
Speedometer “Instant” Calibration:	16
Speedometer “Real-Time” Calibration:	17
Speedometer “Measured Mile” Calibration:.....	18
Optional Shift Indicator Setup:	19
Reset Gauge Calibration to Factory Defaults:.....	19

Welcome from the Team at Classic Instruments!

Our congratulations and appreciation for your purchase of one of the finest quality sets of specialty instruments ever produced! Your instrument set has been conceived, designed, and manufactured by Classic Instruments, Inc. in the U.S.A. Each instrument has been tested and certified for accuracy and quality before packaging and shipping.

For trouble-free installation and operation follow the instructions exactly as outlined. Your instruments were assembled to precise specifications and although each has a seven (7) year warranty covering defective parts and workmanship – this warranty will not cover instruments or sender units which have been installed incorrectly.

Follow our recommended procedures for installation and proper hookup to maintain the value and appearance of your instrument set during many future years of accurate and dependable service!

LIMITED WARRANTY

Classic Instruments, Inc. (CI) warrants to the original purchaser that any CI product manufactured or supplied by CI will be free from defects in material and workmanship under normal use and service for a period of seven (7) years from date of purchase.

Improper installation, use of sending units other than CI's or attempted repair or adjustments by other than CI shall void this warranty. Disassembly of any instruments or senders for whatever reason shall specifically void this warranty.

It's always easy to look to a part for an issue with your set. Before you conclude that a part may be bad, thoroughly check your work. Today's semiconductors and passive components have reached incredibly high reliability levels, but there is still room for error in our human construction skills. However, on rare occasions a sour part can slip through. Please be aware that testing can usually determine if the part was truly defective or damaged by assembly or usage. Don't be afraid of telling us that you "blew it", we're all human and in most cases, replacement parts are very reasonably priced.

Purchaser requesting a product to be repaired or replaced under warranty must first call CI at 1-800-575-0461 before the return of defective part. Send defective part to 826 Moll Drive, Boyne City, MI 49712, USA. Include a written description of the failure with defective part.

Purchaser agrees and accepts that under no circumstances will a warranty replacement be furnished until CI has first received, inspected, and tested the returned part.

All other warranties expressed or implied are hereby excluded including any implied warranty of merchandise and implied warranty of fitness for a particular purpose. The sole and exclusive remedy for breach of this warranty is limited to the replacement set forth above.

It is expressly agreed that there shall be no further remedy for consequential or other type of damage, including any claim for loss of profit, engine damage or injury.

TECHNICAL ASSISTANCE

1-800-575-0461

OR

Visit our website for the latest in gauge design and updates to our installation manual

www.classicinstruments.com

Universal, "Shoebox" & '61-'66 F100 Gauge Mounting

- 1) Insert the gauge cluster from the front of the dash through a 5 ¾" diameter opening.
- 2) Place the "U" shaped bracket over the two mounting studs on the back of the gauge cluster and secure using the supplied nuts.

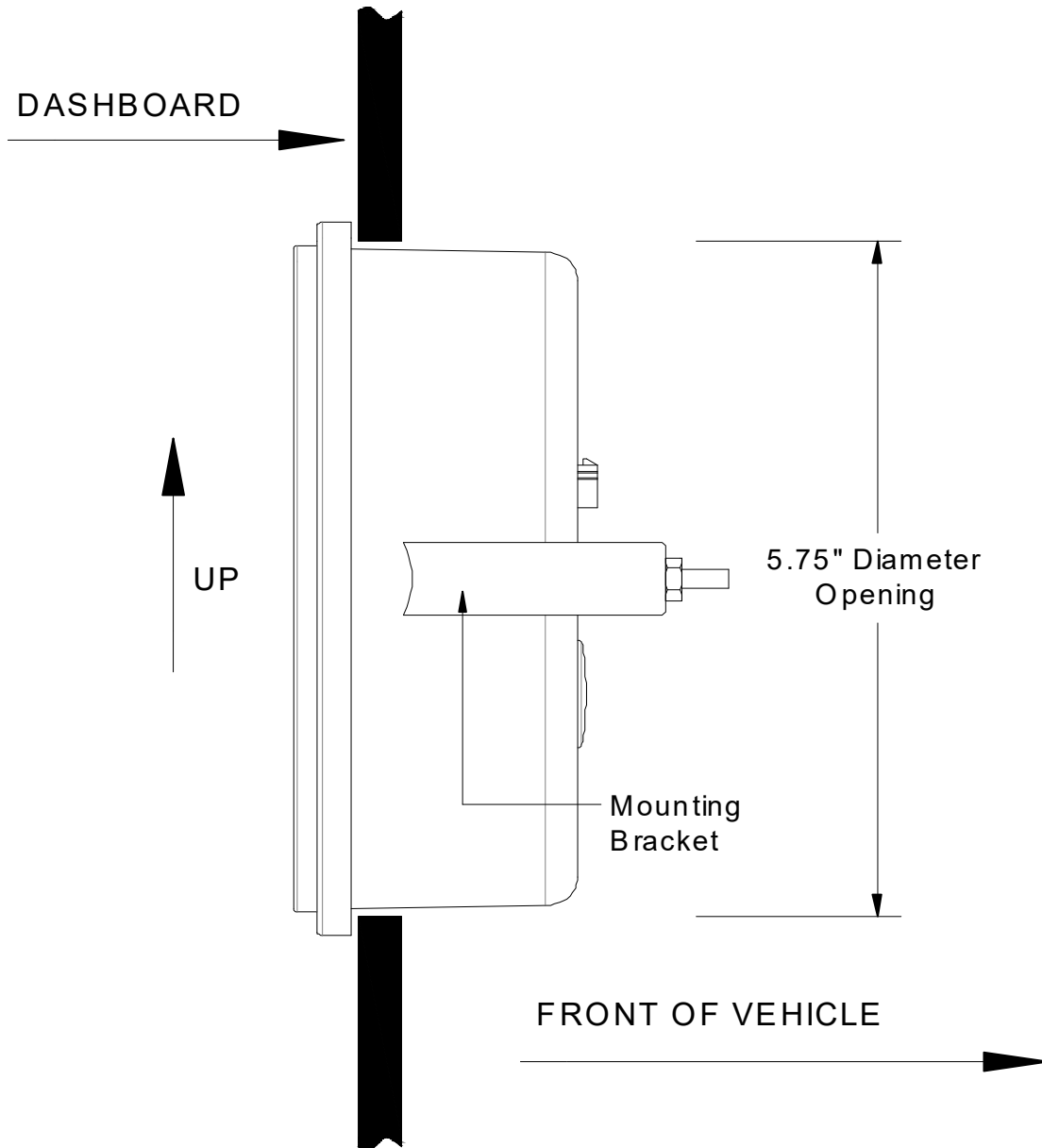

“Bronc Package” Gauge Mounting

- 1) Attach the aluminum adapter bracket to the back side of the dash using the factory gauge cluster mounting holes and the four 10x32 x 1/2” stainless pan-head machine screws.
- 2) Insert the gauge cluster from the front of the dash through the opening in the adapter bracket.
- 3) Place the “U” shaped bracket over the two mounting studs on the back of the gauge cluster and secure using the supplied nuts.

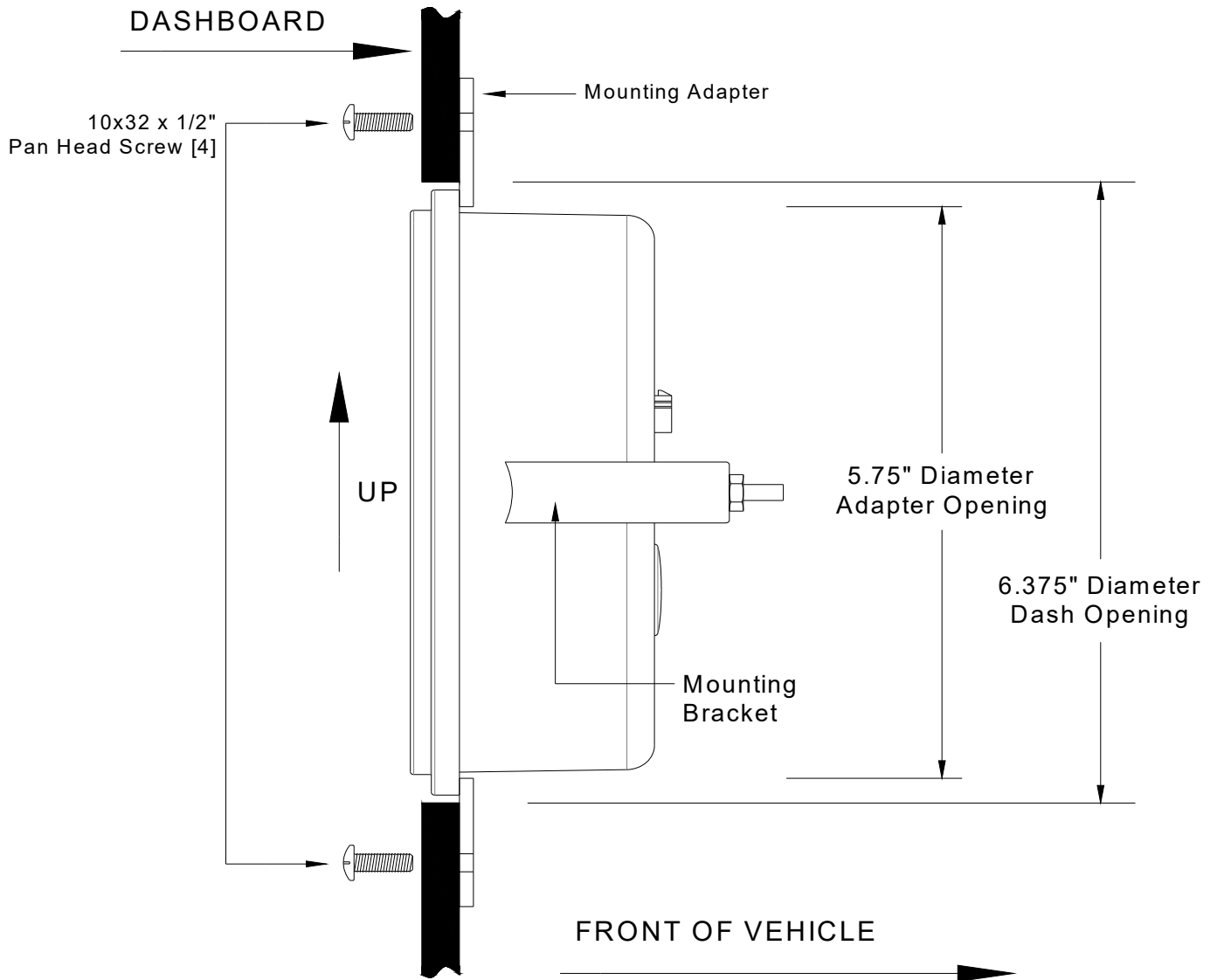

“Classic Line Package” Gauge Mounting

- 1) Attach the aluminum mounting bracket to the back side of the dash using the two factory gauge cluster mounting studs. The slotted holes of the bracket are drilled a little offset from center on the mounting bracket and should be more toward the top of the dash.
- 2) Paint the aluminum mounting adapter to match your dashboard.
- 3) Slide the mounting adapter into the dash opening, starting from the bottom of the dash and sliding upward. The smaller diameter side of the adapter should be at the top.
- 4) Insert the gauge cluster from the front of the dash through the opening in the adapter bracket, making sure to get the gauge mounting studs through the slotted holes in the mounting bracket.
- 5) Secure the gauge in the dash with two nuts on the gauge mounting studs.

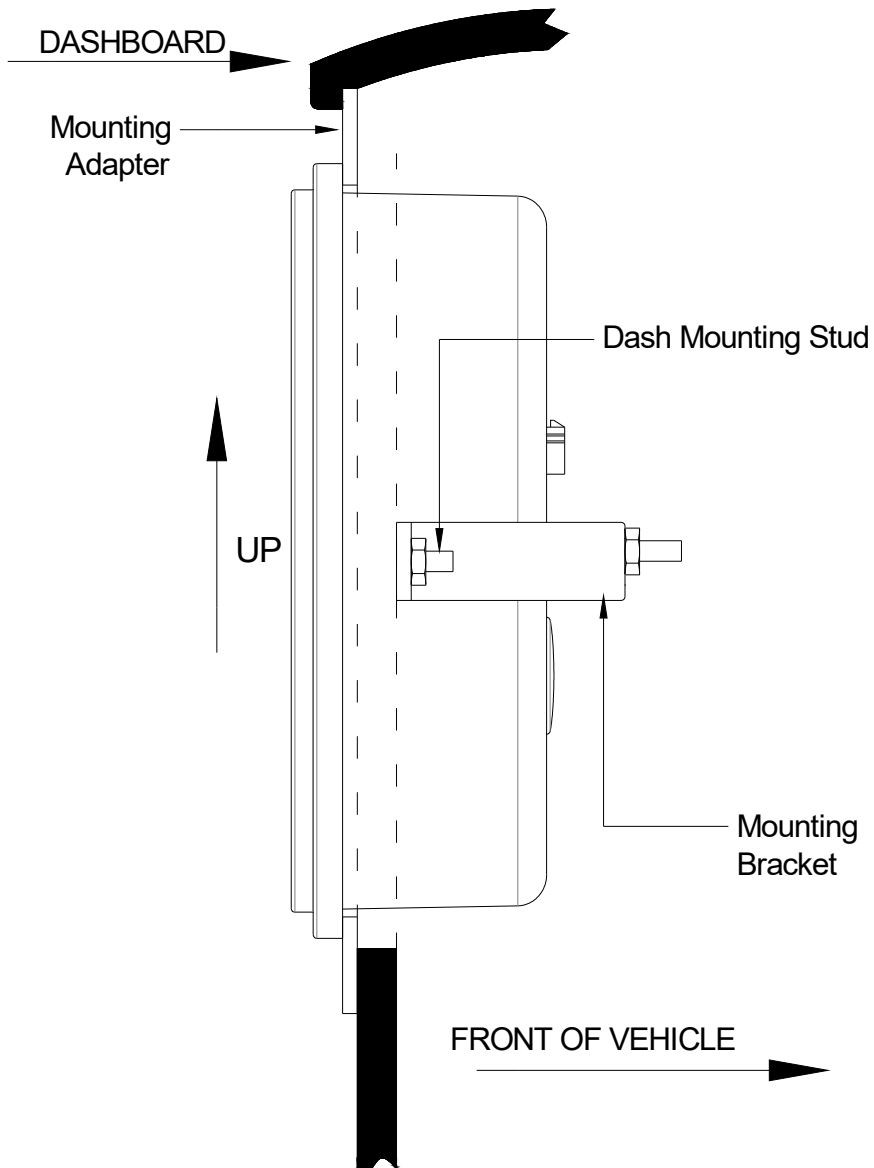

Gauge Cluster Wiring

- 1) Always disconnect the vehicle battery before wiring any gauge.
- 2) Connect a switched +12VDC power source to the **Pink** wire of the gauge wire harness. *We recommend using a dedicated power source (i.e. separate fuse on fuse panel) to avoid possible problems caused by bad “noisy” power.*
- 3) Connect a good chassis ground to the **Black** wire of the gauge wire harness. *We recommend using a dedicated chassis ground (not stacked with other ground wires) to avoid possible problems caused by a bad ground.*
- 4) Connect one of the following speed signals to the **Purple** wire of the gauge wire harness:
 - a. White signal wire from a pulse signal generator [SN16]
 - i. Connect the RED power wire of the SN16 to the **RED** wire of the gauge wire harness.
 - ii. Connect the BLACK ground wire of the SN16 to a good chassis ground.
 - [OR]
 - b. One (*either*) wire of an electronic transmission 2-wire vehicle speed sensor [VSS].
 - i. Connect the *other* wire of the VSS to the same point as the Black ground wire of the gauge wire harness.
 - [OR]
 - c. Speedometer Signal wire of a vehicle computer [PCM].
 - i. Set the Filter Switch on the back of the gauge to ON.
- 5) Connect a tachometer signal to the **White** wire of the gauge wire harness.
 - a. **STANDARD POINTS & CONDENSER SYSTEM**
 - i. Connect to the negative side of the coil (usually marked as “-“).
 - b. **GMC – HEI (High Energy Ignition System)**
 - i. Connect to the “TACH” terminal on coil side of distributor cap.
 - c. **MSD (Multiple Spark Discharge System)**
 - i. Connect to the TACH signal from the MSD box.
 - d. **VERTEX MAGNETO SYSTEM**
 - i. Connect to the “KILL” terminal on the side of a Vertex magneto body. An external adapter such as an MSD “Pro Mag Tach Converter” #8132 may be required.
 - e. **ACCEL IGNITION COILS**
 - i. Connect to the negative side of the coil. CAUTION! Some Accel ignition coils require the tach signal wire to be connected to the “+” terminal on the coil! PLEASE carefully read Accel’s instructions before connecting ignition coil.
 - f. **MALLORY IGNITION**
 - i. Connect to the negative terminal side of coil (usually marked as “-“).
 - g. **ECM TACHOMETER SIGNAL**
 - i. Connect to the signal from the computer. The tachometer typically needs to be set on 4-cylinder setting.
 - h. **MULTIPLE COIL IGNITION SYSTEMS**
 - i. A tach adapter may be required for these ignition systems. A tach signal driver such as the MSD #8913, which produces a 12V square wave signal, is recommended. Please check with manufacturer for your specific application.
 - i. **NOTICE!** For all other ignition systems please look at the owner’s manual for that system.

- 6) Connect the fuel level signal (240-33 ohm) to the **Tan** wire of the gauge wire harness.
- 7) Connect the temperature signal to the **Green** wire of the gauge wire harness.
- 8) Connect the oil pressure signal to the **Blue** wire of the gauge wire harness.
- 9) Connect dash light power to the **Grey** wire of the gauge wire harness.
- 10) Connect high beam indicator power to the **Green / White** wire of the gauge wire harness.
- 11) Connect right turn indicator power to the **Purple / White** wire of the gauge wire harness.
- 12) Connect left turn indicator power to the **Blue / White** wire of the gauge wire harness.
- 13) Connect the **Brown** wire of the gauge wire harness to one wire of the momentary pushbutton.
a. Connect the other wire of the momentary pushbutton to ground.
- 14) The **Yellow** wire of the gauge wire harness is NOT USED.

Dash Light Dimmer

This gauge cluster is equipped with LED lighting. High brightness and low current draw are advantages of LED illumination, however if the brightness is too much for your liking your standard dash light dimmer will not reduce it. A LED dimmer is located on the back of the gauge that can be used to reduce the brightness of the gauge illumination. If you would like to be able to change the gauge illumination but do not want to access the dimmer on the back, a separate LED dimmer module is available. The led dimmer can be wired in-line with the dash light power coming from the light switch and includes a knob that will allow you to remotely adjust the gauge illumination. The part number for this module is LEDDIM and is available directly from Classic Instruments or from a Classic Instruments dealer.

Gauge Wiring Diagram

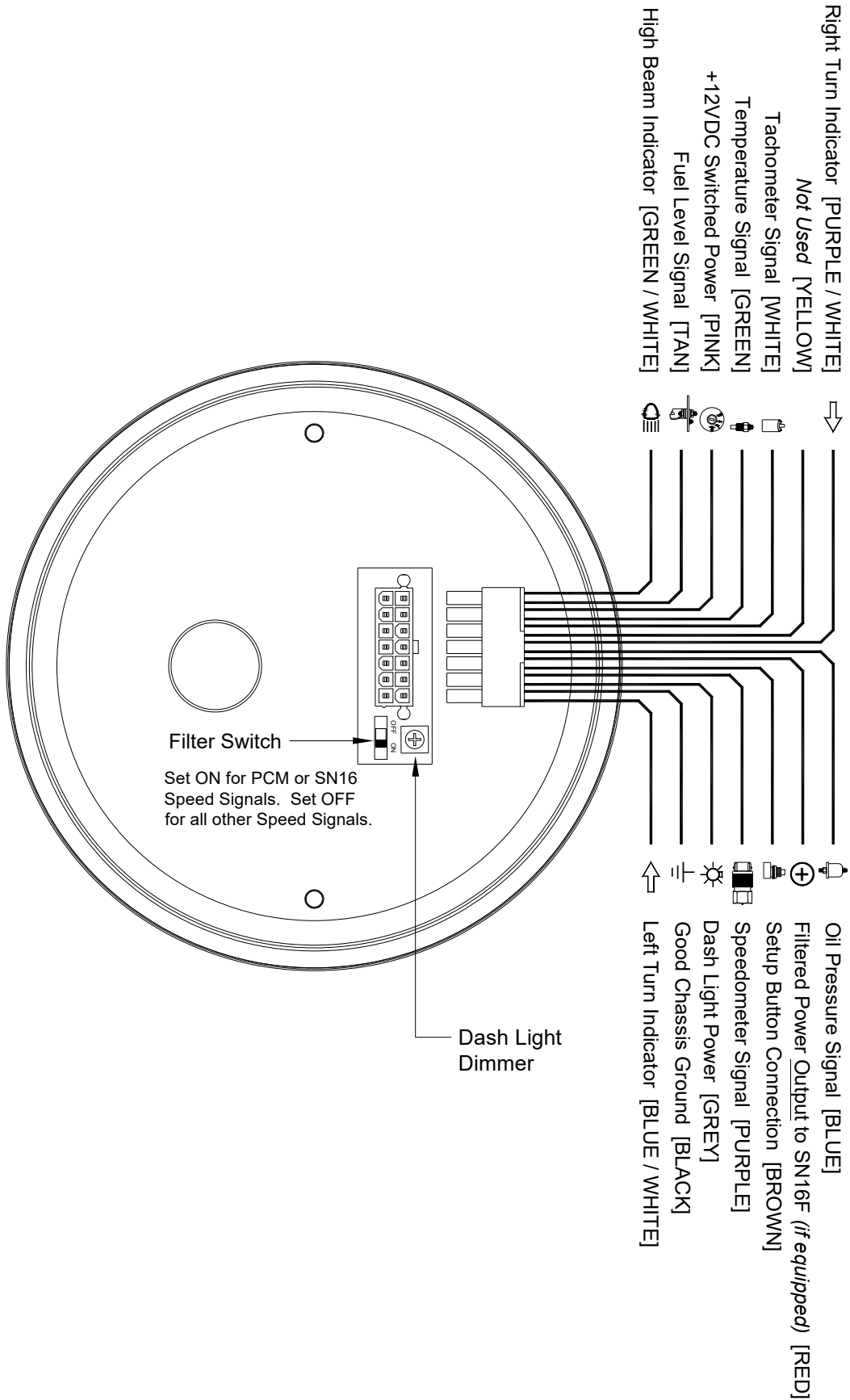

Oil Pressure Sender Installation

(Part No. SN52)

- 1) Disconnect battery before installation.
- 2) Only install Classic Instruments sending units when the engine is COLD.
- 3) DO NOT use Teflon tape on the threads. These threads are slightly tapered and designed to be self-sealing. The sender uses the threads for its ground connection and sealant may cause a poor ground causing inaccurate readings. If supplemental sealant is needed, we recommend using Loctite C5-A anti-seize. This is a copper based anti-seize which will allow a good electrical connection for the sender ground.
- 4) Connect a wire from the top terminal of the oil pressure sender to the **Blue** wire of the gauge wire harness.

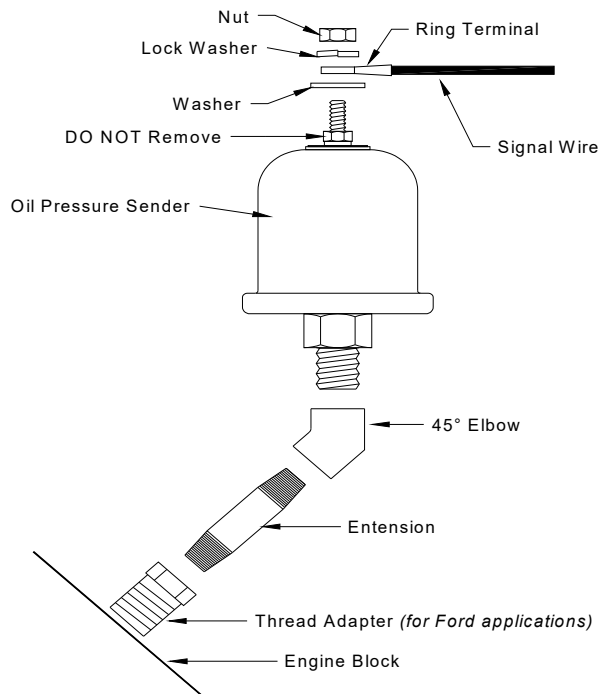

GM Installation: The correct location on most GM V8-engines to install the oil pressure sender is under the distributor housing at the rear of the block.

Use the 2 piece bushing kit provided to allow the sender to be mounted at a 45-degree angle pointing towards the driver's knees. This allows the sender to clear the back of the intake manifold, the underside of the distributor housing and also the firewall.

GM Installation – Big Block Engines: We do NOT recommend installing Classic Instrument's oil pressure sender in the opening located just above the oil filter on some big block GM engines. This location may not be a full-pressure passage but instead a "by-pass" oil passageway. Installing our pressure sender at this location may result in some strange low-pressure readings under certain driving conditions. This does not indicate a defective instrument or sender! It simply means you need to move the sender to the correct location.

GM Installation – LS Engines: Install the sender in the oil bypass housing located just above the oil filter. The housing will need to be drilled and tapped to 1/8"NPT.



LS1 Oil Bypass Housing

Temperature Sender Installation

(Part No. SN12MM, SN22, SN23, SN24 & SN25)

- 1) Disconnect battery before making any connections.
- 2) Install the Classic Instrument's temperature sending unit only when the engine is **COLD!**
- 3) **DO NOT** use Teflon tape on the threads. These threads are slightly tapered and designed to be self-sealing. The sender uses the threads for its ground connection and sealant may cause a poor ground causing inaccurate readings. If supplemental sealant is needed, we recommend using Loctite C5-A anti-seize. This is a copper based anti-seize which will allow a good electrical connection for the sender ground.
- 4) Install the temperature sender into the intake manifold of your engine as possible. Installing the sender in the engine cylinder head may cause inaccurate temperature readings.
 - a. On GM "LS" engines, the temperature sender mounts on the passenger side of the engine under the rear cylinder. A 12mm thread sender [Part # SN12mm] is available to fit this location.
- 5) Connect a wire from the top terminal of the temperature sender to the **Green** wire of the gauge wire harness.
- 6) Tighten until snug. **DO NOT OVER TIGHTEN!**

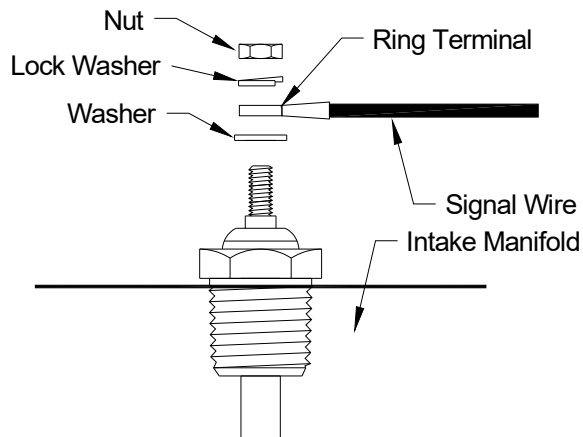

Optional Pulse Signal Generator [SN16] Wiring

Attach the signal generator to the transmission speedometer gear housing (where the speedometer cable originally connected). A speedometer driven gear (not supplied) needs to be installed on the transmission end of the SN17 Ford adapter. Do not use excessive force to tighten. These signal generators produce approximately 16,000 pulses per mile (PPM).

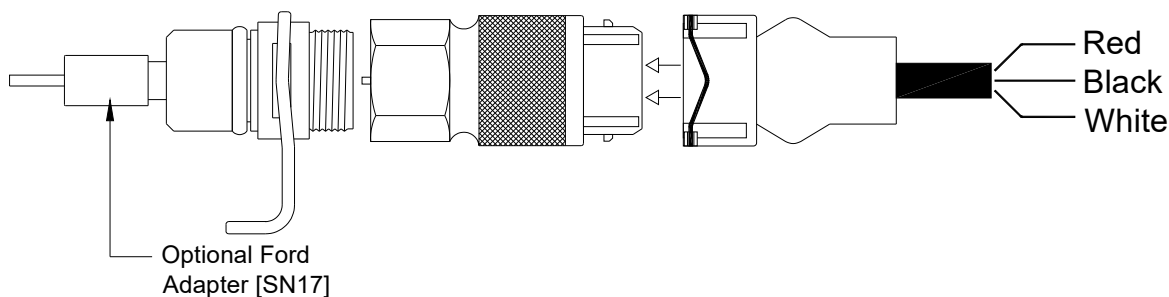

Red: ----- Power (to **Red** wire of gauge)
Black: ----- Ground (to good chassis ground)
White: ----- Signal (to **Purple** wire of gauge)

Universal Fuel Level Sender Installation

- 1) For tank depths of 6" to 15-1/2", it will be necessary to remove the lower mounting bracket.
 1. Begin by removing the two screws and nuts from the lower mounting bracket. These will be discarded.
 2. Remove the two screws from the plastic rheostat housing. Save these screws to use later.
 3. Remove the plastic rheostat housing from the lower mounting bracket and then discard this portion of the mounting bracket.
 4. Reinstall the plastic rheostat housing to the upper mounting bracket and secure using the screws you removed in step "b". (for tank depths 6-7 inches, the top screw is not needed)
- 2) Adjust the float length and pivot point for the tank's depth. See diagram below.

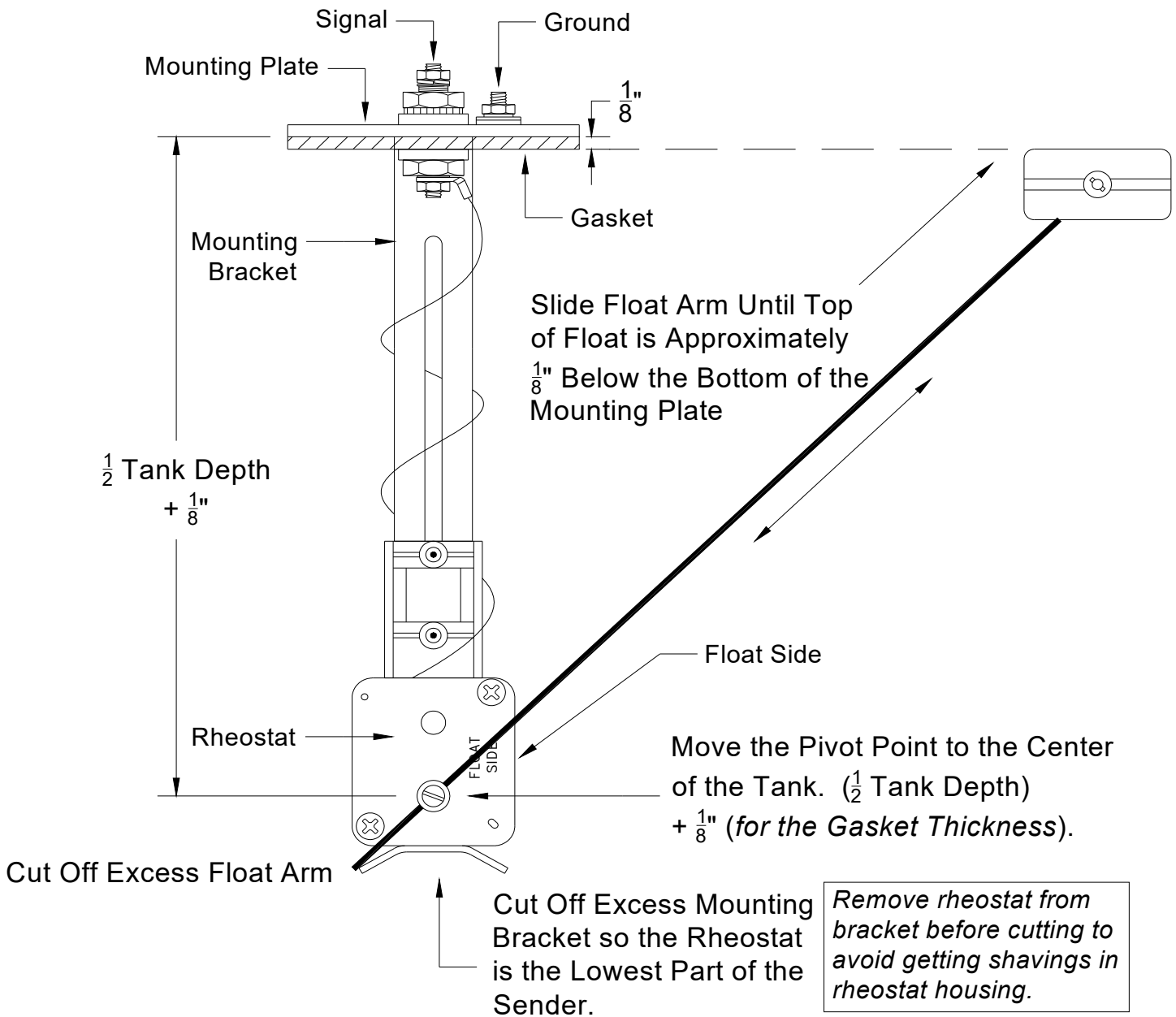

Speedometer & Tachometer Calibration

Note: Before performing speedometer calibration, insure you have a good speed signal. Take a test drive and make sure the speedometer shows a speed (even though it may not be correct)! If the speedometer doesn't show a speed, troubleshoot the speed signal before attempting to calibrate the speedometer.

Only one calibration method is necessary to perform to calibrate the speedometer. Pick the method that works best for you.

- The “Instant” calibration method requires a GPS reference speed signal (or pace car). You will need to drive at 30mph. This method is convenient if the speedometer is more than 10mph off at a known 60mph.
- The “Real-time” calibration method requires a GPS reference speed signal (or pace car). This method allows you to drive at any known speed and make changes to the speedometer reading as you go. This method is best used if the speedometer calibration is less than 10mph off at a known 60mph.
- The “Measured Mile” calibration method requires you to drive a known mile. This is convenient when a GPS is not available to use as a reference and also if the calibration is off more than 10mph at a known 60mph. The speed at which you drive the known mile can be varied, a GPS reference or pace car is not necessary.

Calibration Modes	
Tachometer Indication	Calibration Mode
1000 RPM	Tachometer Cylinder Setup
2000 RPM	Tachometer Signal Type Setup
3000 RPM	Speedometer “Instant” Calibration
4000 RPM	Speedometer “Real-time” Calibration
5000 RPM	Speedometer “Measured Mile” Calibration
6000 RPM	Shift Indicator Setup <i>(if equipped)</i>
7000 RPM	Factory Defaults Reset Mode
8000 RPM	Exit calibration Mode

Entering Calibration Mode:

- 1) Start with power to the gauge OFF.
 - 2) Press and HOLD the calibration pushbutton.
 - 3) Start engine.
 - 4) Release the pushbutton after the engine is started. The gauge will indicate 70MPH and 1000RPM.
The high beam indicator will also be lit [red] to indicate that the gauge is in calibration mode.
-

Tachometer Cylinder Setup: *(steps 1-4 may be skipped if the gauge is already in calibration mode)*

- 1) Start with power to the gauge OFF.
- 2) Press and HOLD the calibration pushbutton.
- 3) Start engine.
- 4) Release the pushbutton after the engine is started. The gauge will indicate 70MPH and 1000RPM. *The high beam indicator will also be lit [red] to indicate that the gauge is in calibration mode.*
- 5) If necessary, tap the calibration pushbutton to index the tachometer pointer until the tachometer indicates 1000RPM.
- 6) With the tachometer indicating 1000RPM, press and hold the calibration pushbutton for 6 seconds. The speedometer pointer will move to indicate the current cylinder setting. *(10MPH=1cylinder, 20MPH=2cylinder, 30MPH=3cylinder, 40MPH=4cylinder, 50MPH=5cylinder, 60MPH=6cylinder, 80MPH=8cylinder, 100MPH=10cylinder and 120MPH=12cylinder)*
- 7) Tap the pushbutton to change the cylinder setting. The speedometer will cycle through the available settings each time the pushbutton is tapped.
- 8) With the speedometer indicating the desired cylinder setting, press and hold the pushbutton for 6 seconds. The gauge will indicate 70MPH and 8000RPM. *The turn signal indicators will be lit [green] to indicate that the cylinder setting has been programmed.*
- 9) If you are finished calibrating the gauge, press and hold the pushbutton while the tachometer is indicating 8000RPM for 6 seconds. This will exit the calibration mode. If you want to calibrate another function of the gauge, tap the pushbutton to index the tachometer to the desired calibration mode.

Tachometer Signal Type Setup: (steps 1-4 may be skipped if the gauge is already in calibration mode)

- 1) Start with power to the gauge OFF.
- 2) Press and HOLD the calibration pushbutton.
- 3) Start engine.
- 4) Release the pushbutton after the engine is started. The gauge will indicate 70MPH and 1000RPM. *The high beam indicator will also be lit [red] to indicate that the gauge is in calibration mode.*
- 5) Tap the calibration pushbutton to index the tachometer pointer until the tachometer indicates 2000RPM.
- 6) With the tachometer indicating 2000RPM, press and hold the calibration pushbutton for 6 seconds. The speedometer pointer will move to indicate the current signal type setting. *The high beam indicator and turn signal indicators will flash [red] and [green].*
- 7) Tap the pushbutton to change the signal type setting. The speedometer will cycle between the two options each time the pushbutton is tapped. (50MPH=Low Voltage Signal, 120MPH=High Voltage Signal)
- 8) Set the signal type to “Low Voltage” if using a computer-generated tachometer signal. Set the signal type to “High Voltage” for all other tachometer signals.
- 9) With the speedometer indicating the desired signal type setting, press and hold the pushbutton for 6 seconds. The gauge will indicate 70MPH and 8000RPM. *The turn signal indicators will be lit [green] to indicate that the signal type setting has been programmed.*
- 10) If you are finished calibrating the gauge, press and hold the pushbutton while the tachometer is indicating 8000RPM for 6 seconds. This will exit the calibration mode. If you want to calibrate another function of the gauge, tap the pushbutton to index the tachometer to the desired calibration mode.

Speedometer “Instant” Calibration: *(steps 1-4 may be skipped if the gauge is already in calibration mode)*

- 1) Start with power to the gauge OFF.
- 2) Press and HOLD the calibration pushbutton.
- 3) Start engine.
- 4) Release the pushbutton after the engine is started. The gauge will indicate 70MPH and 1000RPM. *The high beam indicator will also be lit [red] to indicate that the gauge is in calibration mode.*
- 5) Tap the calibration pushbutton to index the tachometer pointer until the tachometer indicates 3000RPM.
- 6) With the tachometer indicating 3000RPM, press and hold the calibration pushbutton for 6 seconds. The speedometer pointer will move to 0MPH. *The high beam indicator and turn signal indicators will flash [red] and [green] when a speed signal is detected. If no signal is detected, the high beam indicator will be lit [red].*
- 7) Drive the vehicle at exactly 30MPH. Press and hold the pushbutton while traveling 30MPH. *The turn signal indicators will turn off while the button is pressed. When the calibration is completed, the speedometer will move to indicate 30MPH at which point the pushbutton may be released. The turn signal indicators will also be lit [green] to indicate a successful calibration.*
- 8) If you are satisfied with the speedometer calibration, tap the pushbutton once to get back into the main gauge calibration mode. The gauge will indicate 70MPH and 8000RPM. If you would like to re-do the calibration, simply press and hold the pushbutton while traveling 30MPH and hold the pushbutton until the speedometer indicates 30MPH at which point the pushbutton may be released.
- 9) When you are finished calibrating the gauge, tap the pushbutton and the gauge will indicate 70MPH and 8000RPM. Then, Press and hold the pushbutton for 6 seconds. This will exit the calibration mode. If you want to calibrate another function of the gauge, tap the pushbutton to index the tachometer to the desired calibration mode.

Speedometer “Real-Time” Calibration: (steps 1-4 may be skipped if the gauge is already in calibration mode)

- 1) Start with power to the gauge OFF.
- 2) Press and HOLD the calibration pushbutton.
- 3) Start engine.
- 4) Release the pushbutton after the engine is started. The gauge will indicate 70MPH and 1000RPM. *The high beam indicator will also be lit [red] to indicate that the gauge is in calibration mode.*
- 5) Tap the calibration pushbutton to index the tachometer pointer until the tachometer indicates 4000RPM.
- 6) With the tachometer indicating 4000RPM, press and hold the calibration pushbutton for 6 seconds. The speedometer pointer will move to indicate the speed with the current calibration (which you will need to adjust to make correct).
- 7) Press and hold the pushbutton to increase the indicated speed. Release the pushbutton to stop increasing the speed. *The high beam indicator and turn signal indicators will flash [red] and [green] if a speed signal is detected. If no signal is detected, the high beam indicator will be lit red.*
- 8) If necessary, press and hold the pushbutton again to decrease the indicated speed. Release the pushbutton to stop decreasing.
- 9) Press and hold the pushbutton once more to increase the indicated speed. Etc...
- 10) Once the correct speed is dialed in on the speedometer, wait 10 seconds *until the turn signal indicators stop flashing and remain lit [green]* and then tap the pushbutton. The gauge will indicate 70MPH and 8000RPM.
- 11) If you are finished calibrating the gauge, press and hold the pushbutton while the tachometer is indicating 8000RPM for 6 seconds. This will exit the calibration mode. If you want to calibrate another function of the gauge, tap the pushbutton to index the tachometer to the desired calibration mode.

Speedometer “Measured Mile” Calibration: *(steps 1-4 may be skipped if the gauge is already in calibration mode)*

- 1) Start with power to the gauge OFF.
- 2) Press and HOLD the calibration pushbutton.
- 3) Start engine.
- 4) Release the pushbutton after the engine is started. The gauge will indicate 70MPH and 1000RPM. *The high beam indicator will also be lit [red] to indicate that the gauge is in calibration mode.*
- 5) Tap the calibration pushbutton to index the tachometer pointer until the tachometer indicates 5000RPM.
- 6) With the tachometer indicating 5000RPM, press and hold the pushbutton for 6 seconds. The speedometer pointer will move to 30MPH.
- 7) Begin driving a measured mile. While driving, *the high beam indicator and turn signal indicators will flash [red] and [green] to indicate a good speed signal. If no speed signal is detected, the high beam indicator will be lit red.*
- 8) At the end of your measured mile, press and hold the pushbutton for another 6 seconds. The gauge will indicate 70MPH and 8000RPM and *the turn signal indicators will be lit [green] to indicate a successful calibration.*
- 9) If you are finished calibrating the gauge, press and hold the pushbutton while the tachometer is indicating 8000RPM for 6 seconds. This will exit the calibration mode. If you want to calibrate another function of the gauge, tap the pushbutton to index the tachometer to the desired calibration mode.

Optional Shift Indicator Setup: (steps 1-4 may be skipped if the gauge is already in calibration mode)

- 1) Start with power to the gauge OFF.
- 2) Press and HOLD the calibration pushbutton.
- 3) Start engine.
- 4) Release the pushbutton after the engine is started. The gauge will indicate 70MPH and 1000RPM. *The high beam indicator will also be lit [red] to indicate that the gauge is in calibration mode.*
- 5) Tap the calibration pushbutton to index the tachometer pointer until the tachometer indicates 6000RPM.
- 6) With the tachometer indicating 6000RPM, press and hold the pushbutton for 6 seconds. The tachometer pointer will move to 0RPM and *the high beam indicator and turn signal indicators will flash [red] and [green]*. The shift light trigger RPM can now be set.
- 7) Press and hold the pushbutton to increase the tachometer reading. Release the pushbutton to stop increasing the tachometer reading.
- 8) If necessary, push and hold the pushbutton again to decrease the tachometer reading. Release the pushbutton to stop decreasing the tachometer reading.
- 9) Press and hold the pushbutton once more to increase the tachometer reading. Etc...
- 10) When the desired shift light trigger RPM is indicated on the tachometer, release the pushbutton and wait 10 seconds. After 10 seconds of no pushbutton activity, the trigger point will be stored; the tachometer will indicate 8000RPM and *the turn signal indicators will be lit [green]*.
- 11) If you are finished calibrating the gauge, press and hold the pushbutton while the tachometer is indicating 8000RPM for 6 seconds. This will exit the calibration mode. If you want to calibrate another function of the gauge, tap the pushbutton to index the tachometer to the desired calibration mode.

Reset Gauge Calibration to Factory Defaults: (steps 1-4 may be skipped if the gauge is already in calibration mode)

- 1) Start with power to the gauge OFF.
- 2) Press and HOLD the calibration pushbutton.
- 3) Start engine.
- 4) Release the pushbutton after the engine is started. The gauge will indicate 70MPH and 1000RPM. *The high beam indicator will also be lit [red] to indicate that the gauge is in calibration mode.*
- 5) Tap the calibration pushbutton to index the tachometer pointer until the tachometer indicates 7000RPM.
- 6) With the tachometer indicating 7000RPM, press and hold the pushbutton for 6 seconds. The tachometer will move to 8000RPM and *the turn signal indicators will be lit [green] to indicate the gauge has been restored to the factory default settings.*
- 7) If you are finished calibrating the gauge, press and hold the pushbutton while the tachometer is indicating 8000RPM for 6 seconds. This will exit the calibration mode. If you want to calibrate another function of the gauge, tap the pushbutton to index the tachometer to the desired calibration mode.